

**ViewSonic®**



---

**PA500S/PA503S/PA503X/  
PA503W/PA503SP/PA503XP/  
PG603X/PG603W/PG703X/  
PG703W/PG707X/PG707W  
Lamp Swapping Instruction**

# Replacing the lamp



**Turn the power off and disconnect the projector from the power outlet.**

- To reduce the risk of electrical shock, always turn the projector off and disconnect the power cord before changing the lamp.
- To reduce the risk of severe burns, allow the projector to cool for at least 45 minutes before replacing the lamp.
- To reduce the risk of injuries to fingers and damage to internal components, use caution when removing lamp glass that has shattered into sharp pieces. Before replacing the lamp, clean the lamp compartment and dispose of cleaning materials. Be careful of sharp edges in the lamp compartment. Wash hands after lamp replacement.
- Only ViewSonic certified lamps are tested with this projector. Use of other lamps may cause electrical shock and fire.
- Wear working gloves during lamp replacement.
- Unplug projector power at least 10 minutes before replacing the lamp.

1. Turn the power off and disconnect the projector from the wall socket. If the lamp is hot, avoid burns by waiting for approximately 45 minutes until the lamp has cooled.
2. Loosen the screw that secures the lamp cover of the projector until the lamp cover loosens.

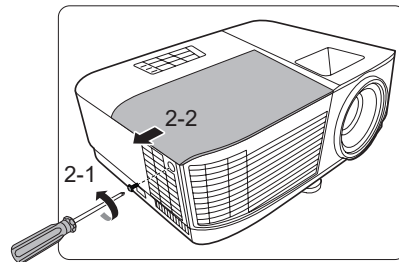

3. Remove the lamp cover from the projector.

## CAUTION

- **Do not turn the power on with the lamp cover removed.**
- **Do not insert your fingers between the lamp and the projector. The sharp edges inside the projector may cause injuries.**

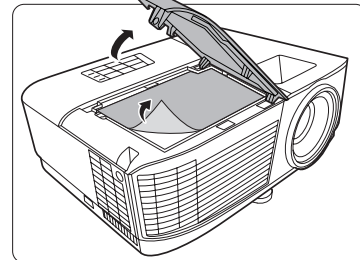

4. Disconnect the lamp connector.
5. Loosen the screw that secures the inner lamp.
6. Lift the handle so that it stands up.

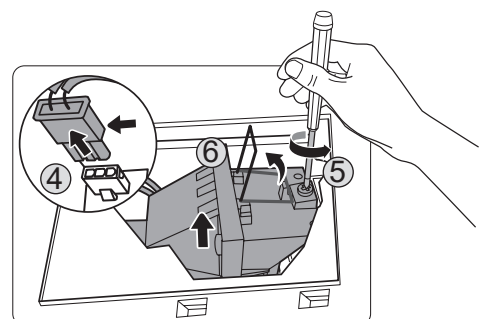

7. Use the handle to slowly pull the lamp out of the projector.

**⚠ CAUTION**

- Pulling it too quickly may cause the lamp to break and scatter broken glass in the projector.
- Do not place the lamp in locations where water might splash on it, children can reach it, or near flammable materials.
- Do not insert your hands into the projector after the lamp is removed. If you touch the optical components inside, it could cause color unevenness and distortion of the projected images.

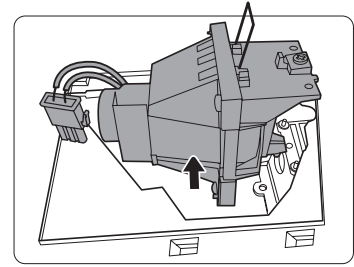

8. As show in the figure, insert the new lamp. Align the lamp using the alignment holes and gently push the lamp into the locked position

**⚠ CAUTION**

- Do not touch glass of lamp with bare hands. Oils from the skin can create a hot spot on the lamp and may result with damage to the lamp.

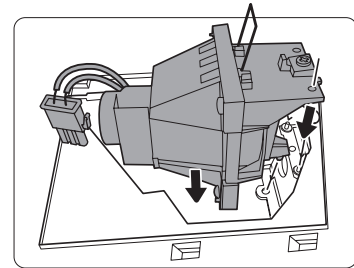

9. Insert the lamp connector and tighten the screw that secures the lamp.

**⚠ CAUTION**

- Loosen screw may cause a bad connection, which could result in malfunction.
- Do not over tighten the screw.

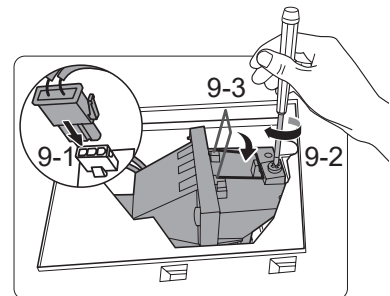

10. Replace the projector's and lamp cover.

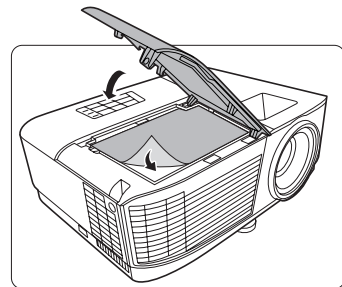

11. Tighten the screws that secure the lamp cover.

**⚠ CAUTION**

- Loosen screw may cause a bad connection, which could result in malfunction.
- Do not over tighten the screw.

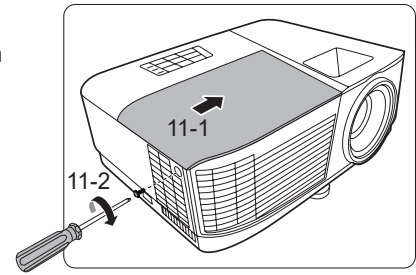

## Replacing the lamp

After powering on the projector, open the OSD menu. Go to **ADVANCED > Lamp Settings > Reset Lamp Hours** and press Enter. The notification message will be displayed if you want to reset the lamp hours. Highlight **Reset** and press Enter. The lamp hours will be reset to "0".

**⚠ CAUTION**

- Do not reset if the lamp is not new or replaced as this could cause damage.



**ViewSonic®**