

# > **LD135-151**

## **All-in-one Direct View LED Display User Guide**

IMPORTANT: Please read this User Guide to obtain important information on installing and using your product in a safe manner, as well as registering your product for future service. Warranty information contained in this User Guide will describe your limited coverage from ViewSonic® Corporation, which is also found on our web site at <http://www.viewsonic.com> in English, or in specific languages using the Regional selection box in the upper right corner of our website. "Antes de operar su equipo lea cuidadosamente las instrucciones en este manual"

Model No. VS18324  
P/N: LD135-151

## **Thank you for choosing ViewSonic®**

As a world-leading provider of visual solutions, ViewSonic® is dedicated to exceeding the world's expectations for technological evolution, innovation, and simplicity. At ViewSonic®, we believe that our products have the potential to make a positive impact in the world, and we are confident that the ViewSonic® product you have chosen will serve you well.

Once again, thank you for choosing ViewSonic®!

# > Safety Precautions

Please read the following **Safety Precautions** before you start using the device.

- Keep this user guide in a safe place for later reference.
- Read all warnings and follow all instructions.
- Ensure there is no direct airflow from air conditioning blowing on the display.
- Do not use the device near water. To reduce the risk of fire or electric shock, do not expose the device to moisture.
- Avoid exposing the device to direct sunlight or other sources of sustained heat.
- Do not install near any heat sources such as radiators, heat registers, stoves, or other devices (including amplifiers) that may increase the temperature of the device to dangerous levels.
- When moving the device, be careful not to drop or bump the device on anything.
- Do not place the device on an uneven or unstable surface. The device may fall over resulting in an injury or a malfunction.
- Do not place any heavy objects on the device or connection cables.
- If smoke, an abnormal noise, or a strange odor is present, immediately turn the device off and call your dealer or ViewSonic®. It is dangerous to continue using the device.
- Do not attempt to circumvent the safety provisions of the polarized or grounding-type plug. A polarized plug has two blades with one wider than the other. A grounding-type plug has two blades and a third grounding prong. The wide blade and the third prong are provided for your safety. If the plug does not fit into your outlet, obtain an adapter and do not attempt to force the plug into the outlet.
- When connecting to a power outlet, DO NOT remove the grounding prong. Please ensure grounding prongs are NEVER REMOVED.
- Protect the power cord from being treaded upon or pinched, particularly at the plug, and at the point where it emerges from the equipment. Ensure that the power outlet is located near the equipment so that it is easily accessible.
- Only use attachments/accessories specified by the manufacturer.
- When a cart is used, use with caution when moving the cart/equipment combination to avoid injury from tipping over.
- Disconnect the power plug from the AC outlet if the device is not being used for a long period of time.



- Place the device in a well-ventilated area.
- Do not cover the surface of the display with any material.
- Do not block the air circulation around the display.
- Keep flammable materials away from the display.
- Refer all servicing to qualified service personnel. Service will be required when the unit has been damaged in any way, such as:
  - » if the power supply cord or plug is damaged;
  - » if liquid is spilled onto or objects fall in the unit;
  - » if the unit is exposed to moisture;
  - » if the unit does not operate normally or has been dropped.
- Do not assemble the display by yourself.
- This panel is an advanced product that contains millions of pixels. You may occasionally see pixel spots when viewing the screen. Since these deactivated pixels are not a defect, the performance and reliability of the product is not affected. For more information, please see page 89.



# > Contents









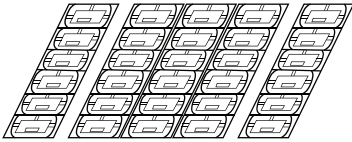
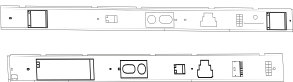

|  |           |
|--|-----------|
| <b>Safety Precautions.....</b>                           | <b>3</b>  |
| <b>Introduction .....</b>                                | <b>8</b>  |
| Package Contents .....                                   | 8         |
| Product Overview .....                                   | 9         |
| Front Panel .....  | 9         |
| Rear Panel .....   | 9         |
| I/O Control Panel.....                                   | 10        |
| Remote Control .....                                     | 11        |
| <b>Installation .....</b>                                | <b>14</b> |
| Wall Mounting.....                                       | 14        |
| Installing the Upper and Lower Wall Mount Brackets ..... | 14        |
| Installing the Middle Cabinets.....                      | 16        |
| Installing the Left and Right Cabinet .....              | 18        |
| Connecting the System Control Box.....                   | 20        |
| Installing the LED Modules .....                         | 22        |
| Installing System Control Box Covers .....               | 23        |
| Floor Stand Installation.....                            | 25        |
| Component List .....                                     | 25        |
| Constructing the Floor Stand .....                       | 27        |
| Connecting the System Control Box to the Floor Base..... | 29        |
| Installing the Middle Cabinets.....                      | 30        |
| Installing the Left and Right Cabinet .....              | 33        |
| Connect the Network and Power Cables .....               | 34        |
| Installing the LED Modules .....                         | 35        |
| Installing System Control Box Covers .....               | 36        |
| <b>Making Connections .....</b>                          | <b>38</b> |
| Connecting to External Devices .....                     | 38        |
| HDMI IN Connection .....                                 | 38        |
| Audio Connection.....                                    | 38        |
| Video Output Connection .....                            | 38        |
| USB and Networking Connections .....                     | 39        |
| RS-232 Connection .....                                  | 39        |

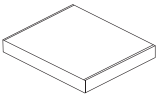
|   |           |
|---|-----------|
| <b>Using Your Display.....</b>          | <b>40</b> |
| Powering On/Off your LED Display .....  | 40        |
| Home Screen .....                       | 41        |
| Navigating the Home Screen .....        | 42        |
| Remote Control .....                    | 42        |
| Keyboard and Mouse .....                | 42        |
| APP Center.....                         | 43        |
| Input Source .....                      | 44        |
| Settings .....                          | 45        |
| Settings Menu Tree .....                | 46        |
| Network & Internet.....                 | 51        |
| Connected Devices .....                 | 54        |
| Apps & Notifications .....              | 55        |
| Display .....                           | 58        |
| Sound .....                             | 61        |
| Storage .....                           | 62        |
| System .....                            | 63        |
| Upgrade.....                            | 65        |
| On-Screen Display (OSD) Menu .....      | 66        |
| On-Screen Display (OSD) Menu Tree ..... | 67        |
| Menu Options .....                      | 70        |
| Picture .....                           | 70        |
| Sound .....                             | 72        |
| Time.....                               | 74        |
| NetWork .....                           | 77        |
| Update.....                             | 79        |
| Advanced.....                           | 80        |
| <b>Embedded Applications.....</b>       | <b>82</b> |
| ViewBoard Cast .....                    | 82        |
| vSweeper .....                          | 86        |
| Browser .....                           | 87        |
| WPS Office.....                         | 87        |

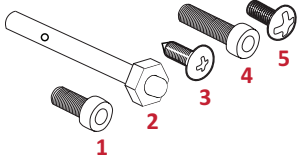
|  |            |
|--|------------|
| <b>Appendix.....</b>                             | <b>88</b>  |
| Specifications.....                              | 88         |
| LED Display Stuck Pixel Definition .....         | 89         |
| Timing Chart .....                               | 90         |
| HDMI (PC).....                                   | 90         |
| HDMI (Video).....                                | 91         |
| Supported Media Formats.....                     | 92         |
| Troubleshooting .....                            | 94         |
| Maintenance.....                                 | 96         |
| General Precautions .....                        | 96         |
| Initial Operation .....                          | 96         |
| Front Panel Cleaning Instructions .....          | 96         |
| Cabinet Cleaning Instructions .....              | 96         |
| Regular Use .....                                | 97         |
| Vacuum Suction Tool.....                         | 98         |
| LED Module Disassembly .....                     | 100        |
| <b>RS-232 Protocol.....</b>                      | <b>102</b> |
| RS-232 Hardware Specification .....              | 102        |
| RS-232 Communication Setting.....                | 102        |
| Command Table .....                              | 103        |
| <b>Regulatory and Service Information .....</b>  | <b>104</b> |
| Compliance Information.....                      | 104        |
| FCC Compliance Statement.....                    | 104        |
| IC Warning Statement .....                       | 105        |
| Country Code Statement.....                      | 105        |
| IC Radiation Exposure Statement.....             | 106        |
| CE Conformity for European Countries .....       | 106        |
| Declaration of RoHS2 Compliance.....             | 107        |
| European Union Regulatory Conformance .....      | 107        |
| Indian Restriction of Hazardous Substances ..... | 108        |
| Product Disposal at End of Product Life .....    | 108        |
| Copyright Information .....                      | 109        |
| Customer Service .....                           | 110        |
| Limited Warranty .....                           | 111        |
| Mexico Limited Warranty.....                     | 114        |

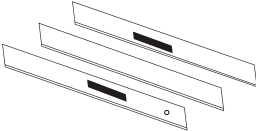
# > Introduction

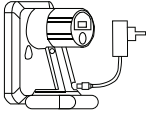
## Package Contents

| Item  | Quantity  | Note  |   |
|---|---|---|---|
| Cabinet Sections  |    | 5 sections total  | One (1) Left, three (3) Middle, and one(1) Right.       |
| System Control Box (Left and Right sides)                 |    | 2 sides   |   |
| Quick Start Guide   |    | 1   |   |
| LED Modules   |    | 100 modules   | The quantity of spare LED modules will vary by country. |
| Remote Control  |   | 1   |   |
| Screws  |  | 16 x M6x10mm (1)<br>32 x M6x50mm Expansion (2)<br>32 x TA6x30mm (3)<br>20 x M6x16mm (4)<br>12 x KM3x6mm (5) |   |
| Hex Tool  |  | 1   |   |
| System Control Box Covers (Left, Middle, and Right sides) |  | 3   |   |
| Wall Mounting Brackets                                    |  | 4   |   |
| Vacuum Suction Tool                                       |  | 1   |   |
| Anti-Static Gloves  |  | 2 pairs   |   |
| USB-A to USB-B Cable (5m)                                 |  | 1   |   |

### NOTE:

- This product is packed in an air transport box.
- Due to the size and weight, it is recommended that two or more people handle it.
- The base stand is an optional accessory and will be sold separately.

# Product Overview

## Front Panel

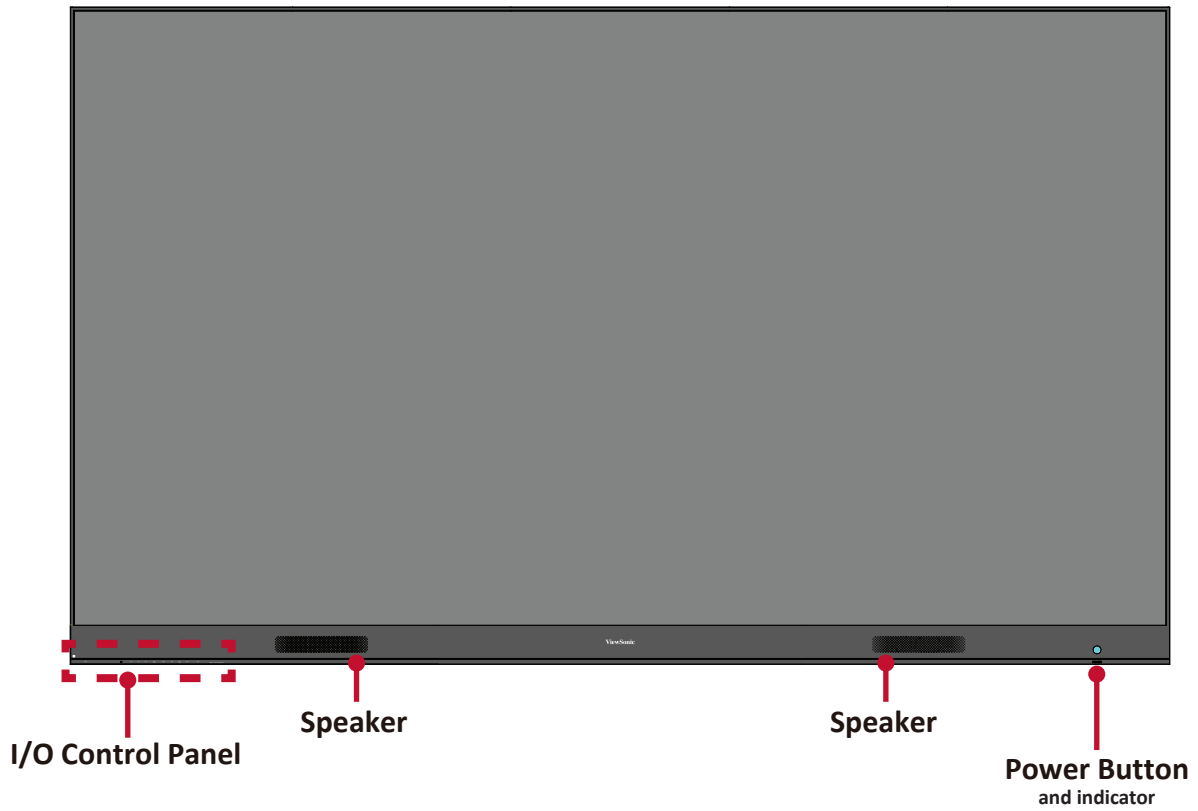







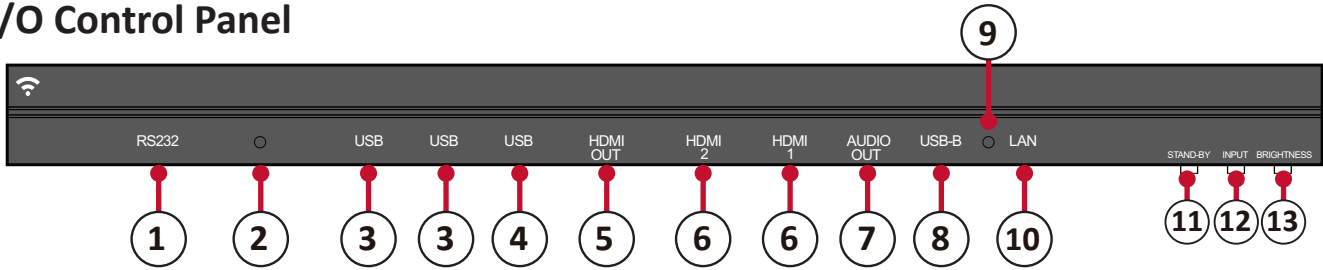

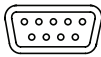

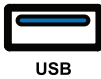

## Rear Panel



## I/O Control Panel



| Number | Item   | Port                 | Description  |
|--------|--|----------------------|--|
| 1      |         | RS-232               | Serial control port.   |
| 2      |         | Ambient Light Sensor | Detects ambient light and adjusts brightness levels automatically.                         |
| 3      | <br>USB | USB 2.0              | USB Reader (5V/0.5A)   |
| 4      | <br>USB | USB 3.0              | USB Reader (5V/1A)   |
| 5      |         | HDMI Out             | Extend content out to another display device.  |
| 6      |       | HDMI In              | High definition input; connect to PC with HDMI output, set-top box, or other video device. |
| 7      |       | Audio Out            | Audio output to an external speaker.   |
| 8      |       | USB-B                | Maintenance port for external PC connection.   |
| 9      |       | IR Receiver          | Receiver for the Remote Control.   |
| 10     |       | LAN                  | Standard RJ45 (10M/100M/1000M) Internet connection interface.                              |
| 11     |       | Stand-by             | Press to enter Stand-by mode.  |
| 12     |       | Input Select         | Press to cycle through available input sources.  |
| 13     |       | Brightness           | Press to cycle through brightness levels.  |

### Locking the Control Panel

When the administrator does not want others to use the control panel, it can be locked by pressing 1168+OK on the remote control.

# Remote Control

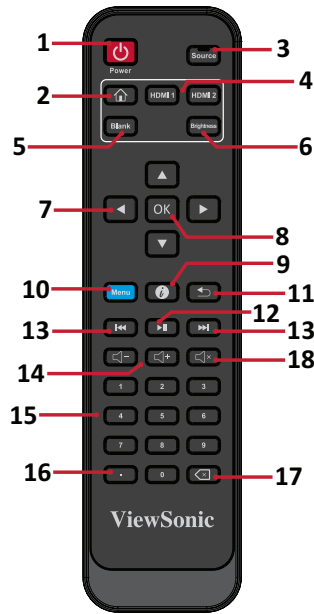

| Number | Icon | Item               | Description                        |
|--------|------|--------------------|------------------------------------|
| 1      |      | Power              | Power On/Off                       |
| 2      |      | Home               | Back to Home Screen                |
| 3      |      | Source             | Input source selection             |
| 4      |      | HDMI 1/2           | Change to HDMI 1/2 input source    |
| 5      |      | Blank              | Switch to a blank, black screen    |
| 6      |      | Brightness         | Adjust the brightness level        |
| 7      |      | ▲/▼/◀/▶            | Directional buttons                |
| 8      |      | OK                 | Confirm the selection              |
| 9      |      | i                  | Enter the Information page         |
| 10     |      | Menu               | Enter the Settings menu            |
| 11     |      | Return             | Return to previous                 |
| 12     |      | Play/Pause         | Play/Pause content                 |
| 13     |      | Forwards/Backwards | Move content forwards/backwards    |
| 14     |      | Volume Up/Down     | Increase/decrease the volume level |
| 15     |      | Numbers            | Numeric input buttons              |
| 16     |      | .                  | Input key for a dot                |
| 17     |      | Backspace/Clear    | Delete key for text input          |
| 18     |      | Mute               | Mute/Unmute                        |

## Inserting Remote Control Batteries

The remote control is powered by two 1.5v "AAA" batteries.

To insert batteries into the remote control:

1. Remove the cover on the rear of the remote control.
2. Insert two "AAA" batteries, ensuring the "+" symbol on the battery matches the "+" on the battery post.
3. Replace the cover by aligning it with the slot on the remote control and snapping the latch shut.

**WARNING:** There is a risk of explosion if batteries are installed with incorrect polarity.

### NOTE:

- It is recommended that you do not mix battery types.
- Avoid exposure to heat or steam.
- Do not allow water or other liquids to splash on the remote control. If the remote control becomes wet, wipe it dry immediately.
- Always dispose of old batteries in an environmentally friendly way. Contact your local government for more information on how to dispose of batteries safely.

## Locking the Remote Control

When the administrator does not want others to control the remote control, it can be locked by pressing 1169+OK on the remote control.



## Remote Control Receiver Range

The operating range of the remote control is shown here. It has an effective range of 20 feet (6 meters), 30° degrees left and right. Ensure there is nothing obstructing the remote control's signal to the receiver.

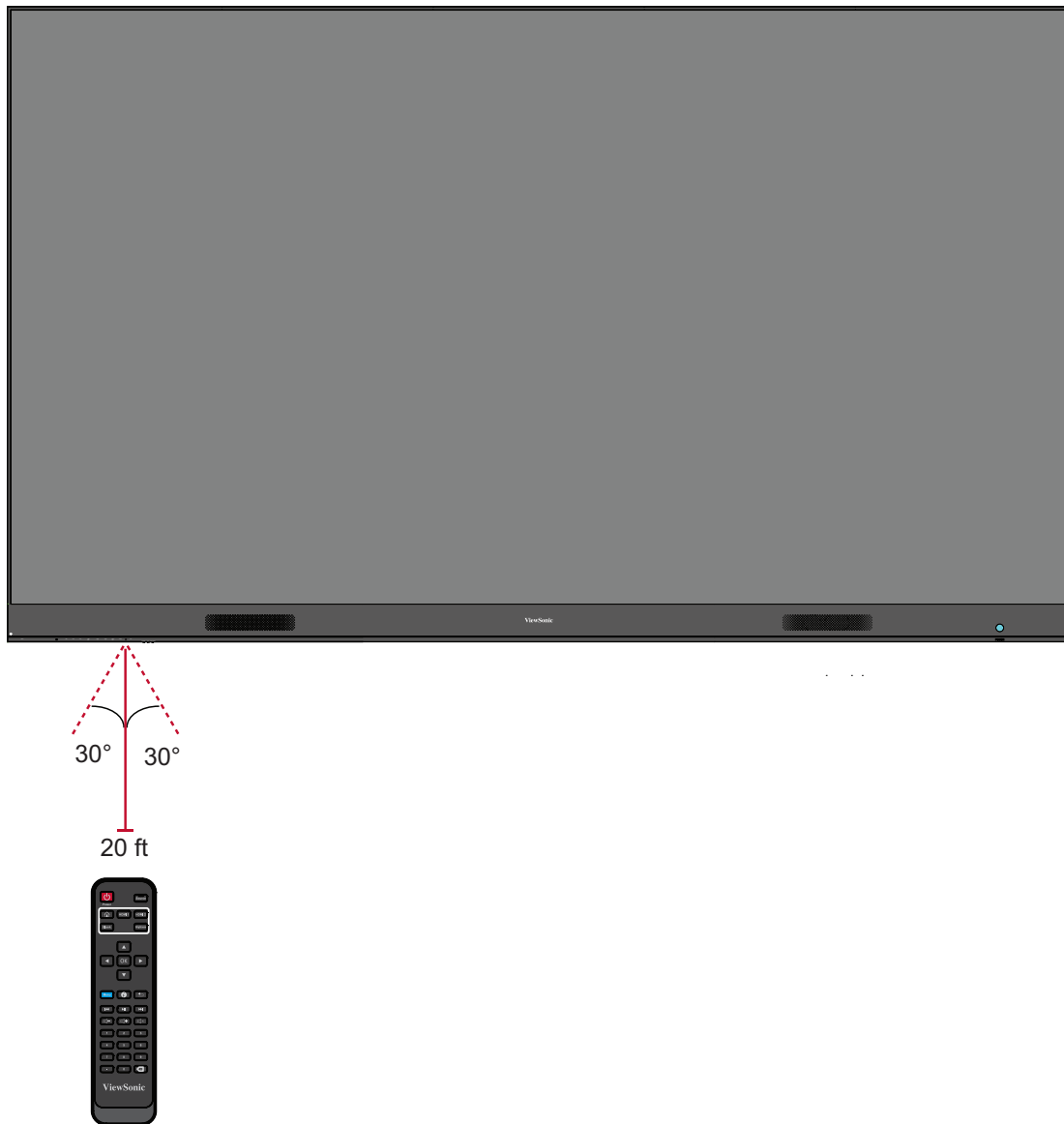

# > Installation

There are two installation methods: Wall-Mounted and Floor Stand.

## Before Installing

- ! Maintain an adequate air gap between the back of the display and any wall for proper ventilation.
- ! Ensure there is no direct airflow from air conditioning or heating vents blowing on the display.
- ! Avoid installing the display in places with high humidity.
- ! Due to high power usage, always use power cords specifically designed for this product.

## Wall Mounting

### Installing the Upper and Lower Wall Mount Brackets

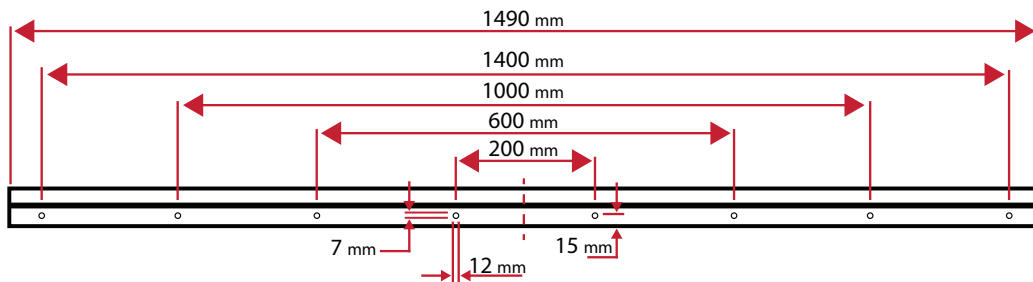

1. Ensure the wall area and size is an appropriate installation site.

**NOTE:** The height of the Upper *Wall Mount Brackets* must not be less than 90.55" (2.3 meters) from the ground.

2. Using the *Wall Mount Bracket* (pictured above) as a guide, mark each of the eight (8) holes and pre-drill each.
3. Install the first Upper *Wall Mount Bracket* with the provided screws (M6x50mm Expansion for masonry; TA6x30mm for load bearing wood).
4. Repeat **Step 2**, ensuring the second Upper *Wall Mount Bracket* is level with the first upper bracket.

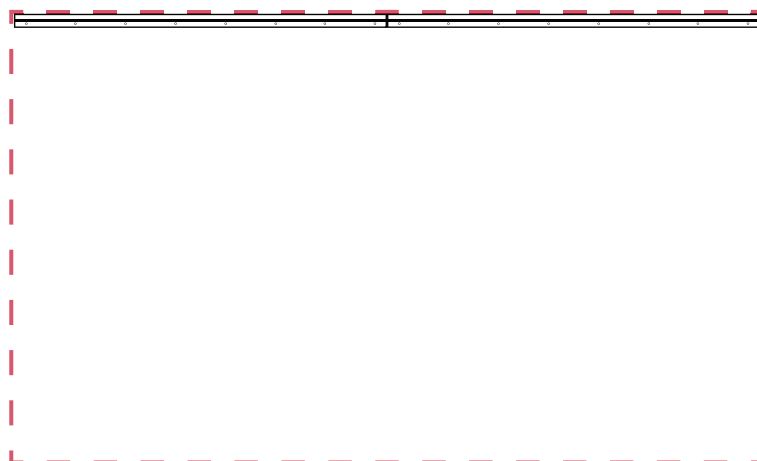

5. Install the Lower *Wall Mount Brackets* in the same manner as the *Upper Wall Mount Brackets*. The distance between the Upper and Lower *Wall Mount Brackets* is 64-1/16" (1627.5 mm).

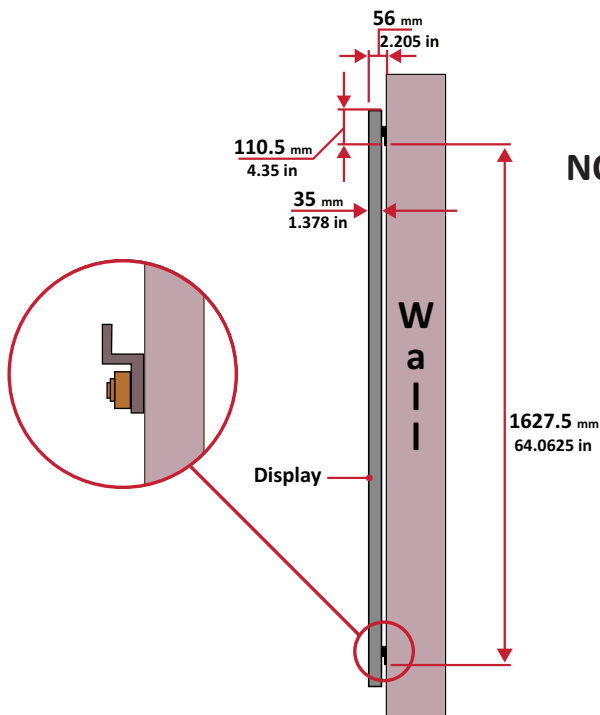

**NOTE:** You can also install the *Upper Wall Mount Brackets*, hang the screen, and then install the *Lower Wall Mount Brackets* for a more precise fit.

- ! Ensure the wall can safely support 297.62 lbs. (135 kg).
- ! Ensure the wall surface deviation is < 0.197 in. (5mm).

6. After installing both Upper and Lower *Wall Mount Brackets*, the installation wall should look like:



## Installing the Middle Cabinets

1. Ensure the *Mounting Brackets* on the rear of the three (3) *Middle Cabinets* are positioned at the top and bottom mounting positions as shown below:

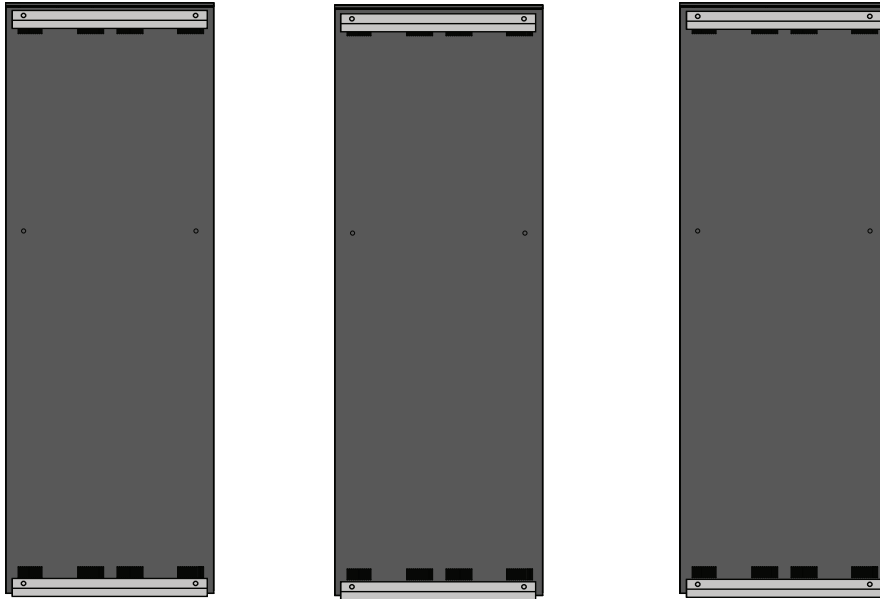

2. Carefully lift each *Middle Cabinet* up onto the *Upper Wall Mount Brackets*.

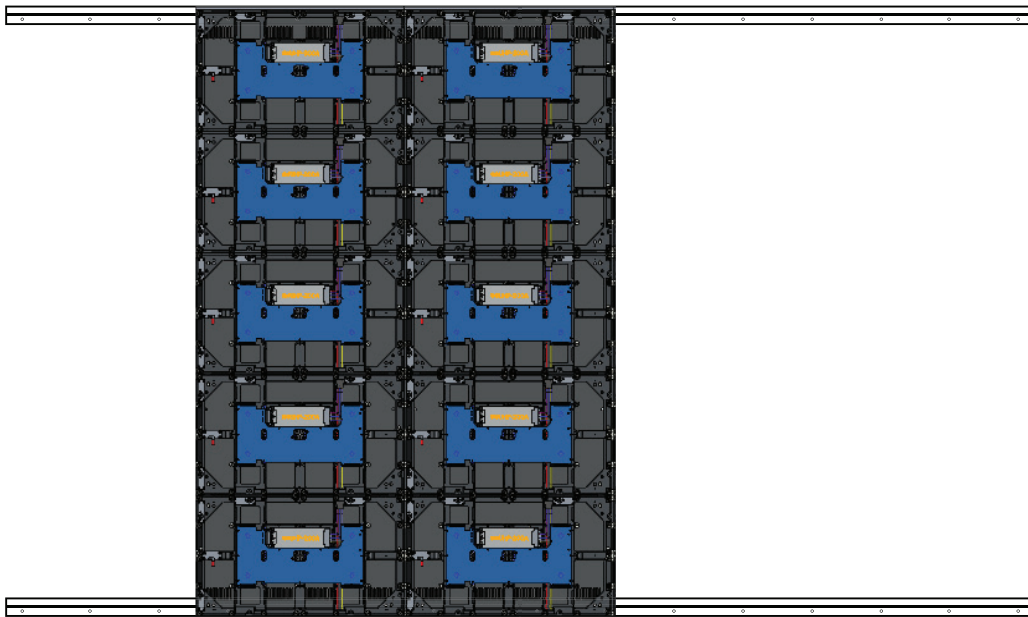

3. Ensure the *Mounting Brackets* sit securely on the *Wall Mount Brackets* as shown below.

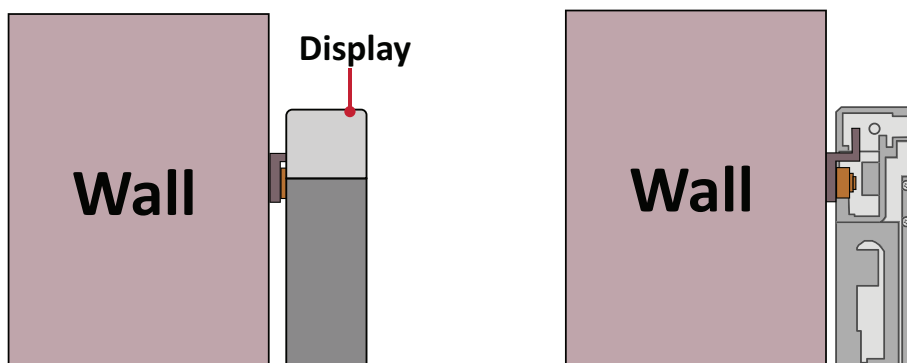

4. Push each *Locking Bolt* and lock each *Hook* with the hex tool to securely connect each cabinet together.

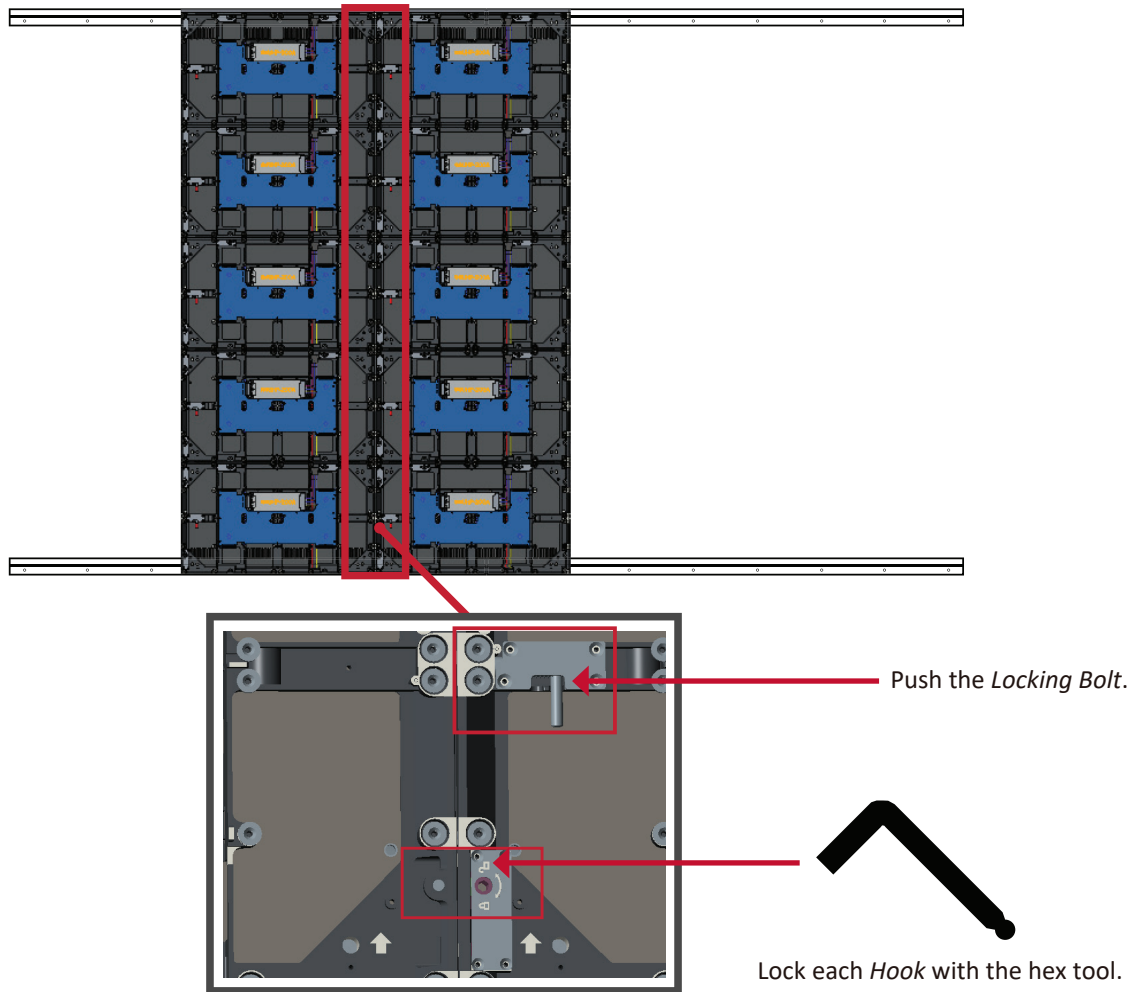

**NOTE:** There are five (5) *Locking Bolts* and 10 *Hooks* between each cabinet.

5. Lift the remaining *Middle Cabinet* up onto the *Upper Wall Mount Brackets*, ensuring the *Mounting Brackets* sit securely on the *Wall Mount Brackets*.
6. Repeat Step 4, securing the cabinets together with each *Locking Bolt* and *Hook*.

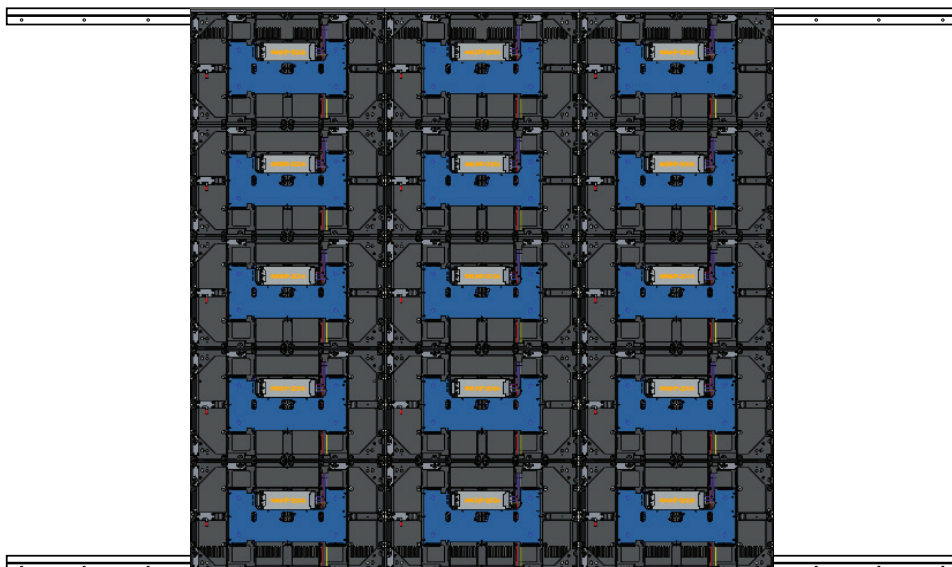

## Installing the Left and Right Cabinet

1. Ensure the *Mounting Brackets* on the rear of the *Left* and *Right Cabinet* are positioned at the top and bottom mounting positions as shown below:



2. Carefully lift the *Left* and *Right Cabinet* up onto the *Upper Wall Mount Brackets*, ensuring the *Mounting Brackets* sit securely on the *Wall Mount Brackets*.

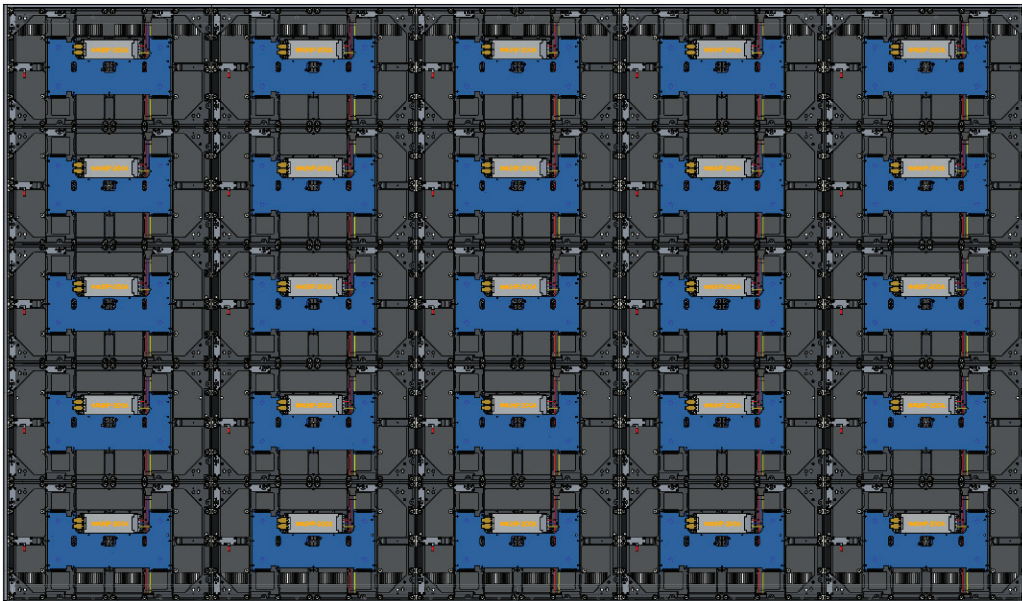

3. If necessary, adjust the *Left* or *Right Cabinet* so that they fit seamlessly with the *Middle Cabinets*.

4. Push each *Locking Bolt* and lock each *Hook* with the hex tool to securely connect the *Left* and *Right Cabinets*.

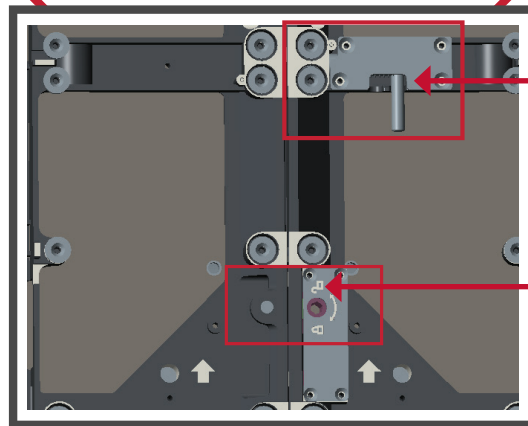
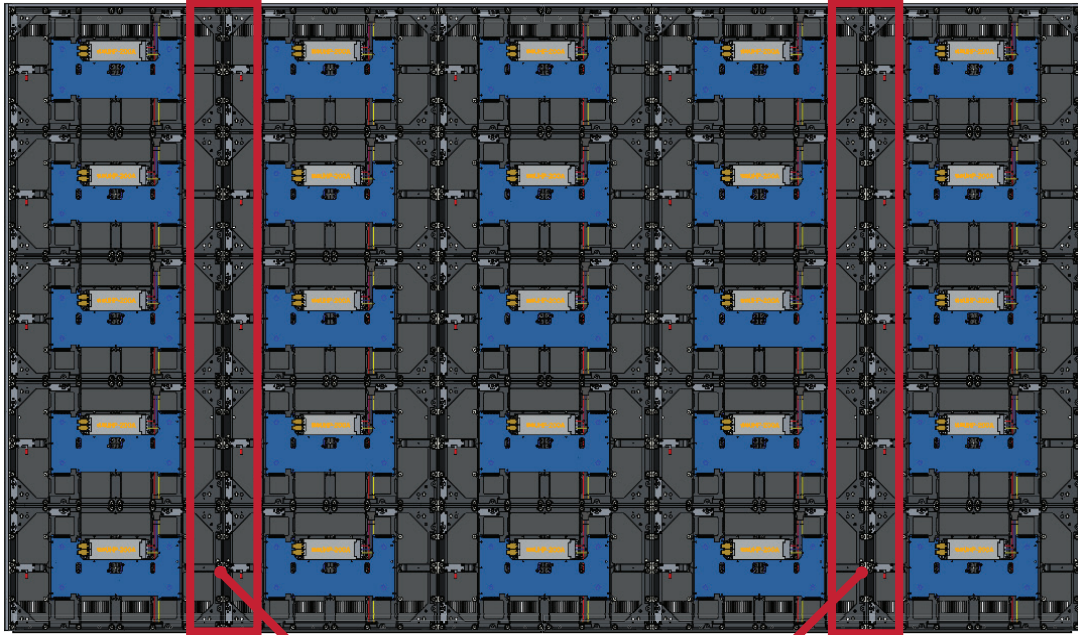

Push the *Locking Bolt*.

Lock each *Hook* with the hex tool.

**NOTE:** There are five (5) *Locking Bolts* and 10 *Hooks* between each cabinet.



## Connecting the System Control Box

1. Carefully unfold the *System Control Box* panel. Ensure the main system control board is on the left.

**NOTE:** Use caution as the *System Control Box* panel will be separated into two pieces, however the wires are connected.

2. Align the holes of the *Cabinet* with the *System Control Box* to attach.

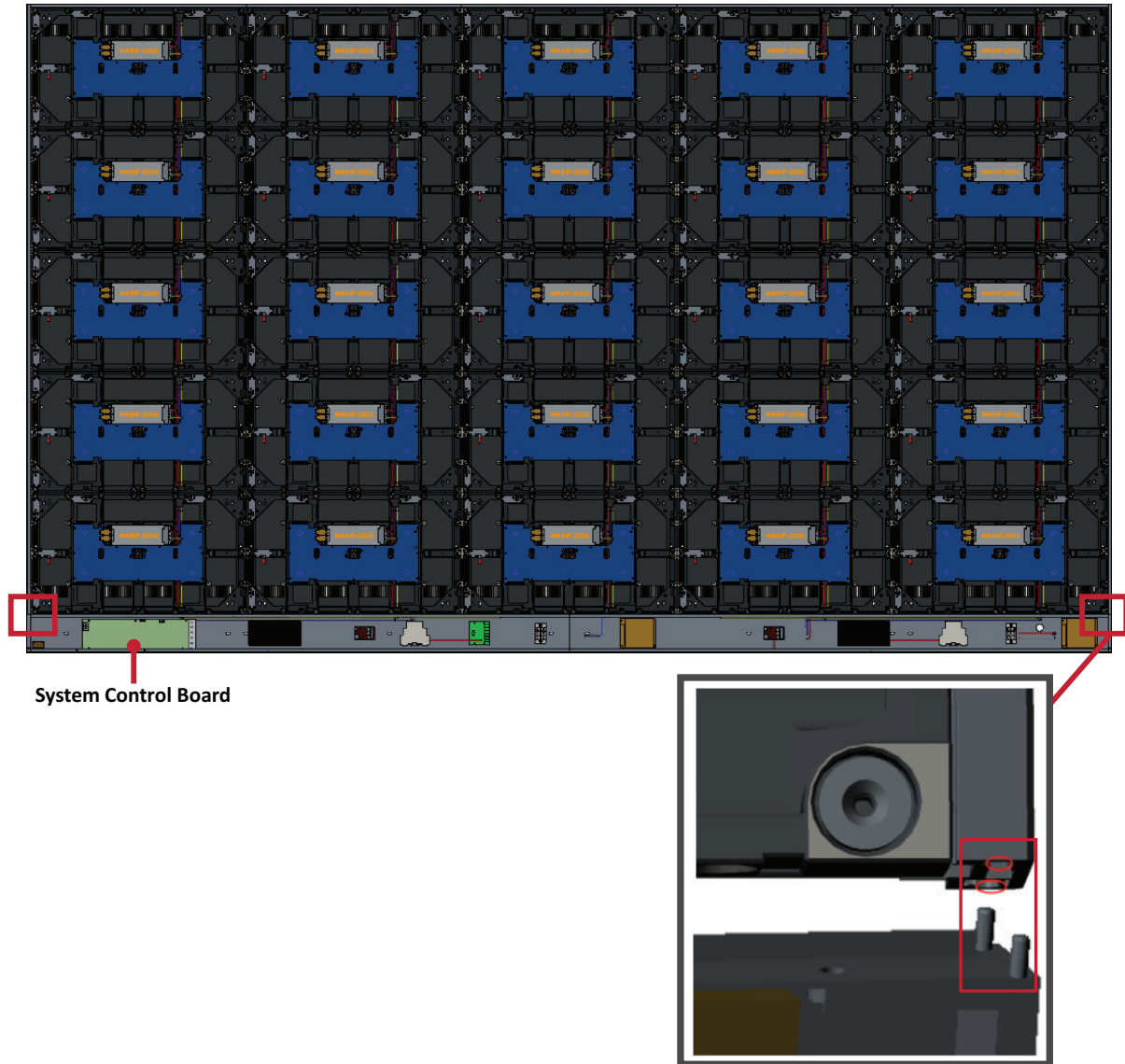

3. Further secure the *System Control Box* to the *Cabinets* with the 20 provided screws (M6x16mm).





4. Connect the Network and Power cables of the *Cabinets* to the *System Control Box*.

**NOTE:** There are five (5) Network and five (5) Power cables to connect.

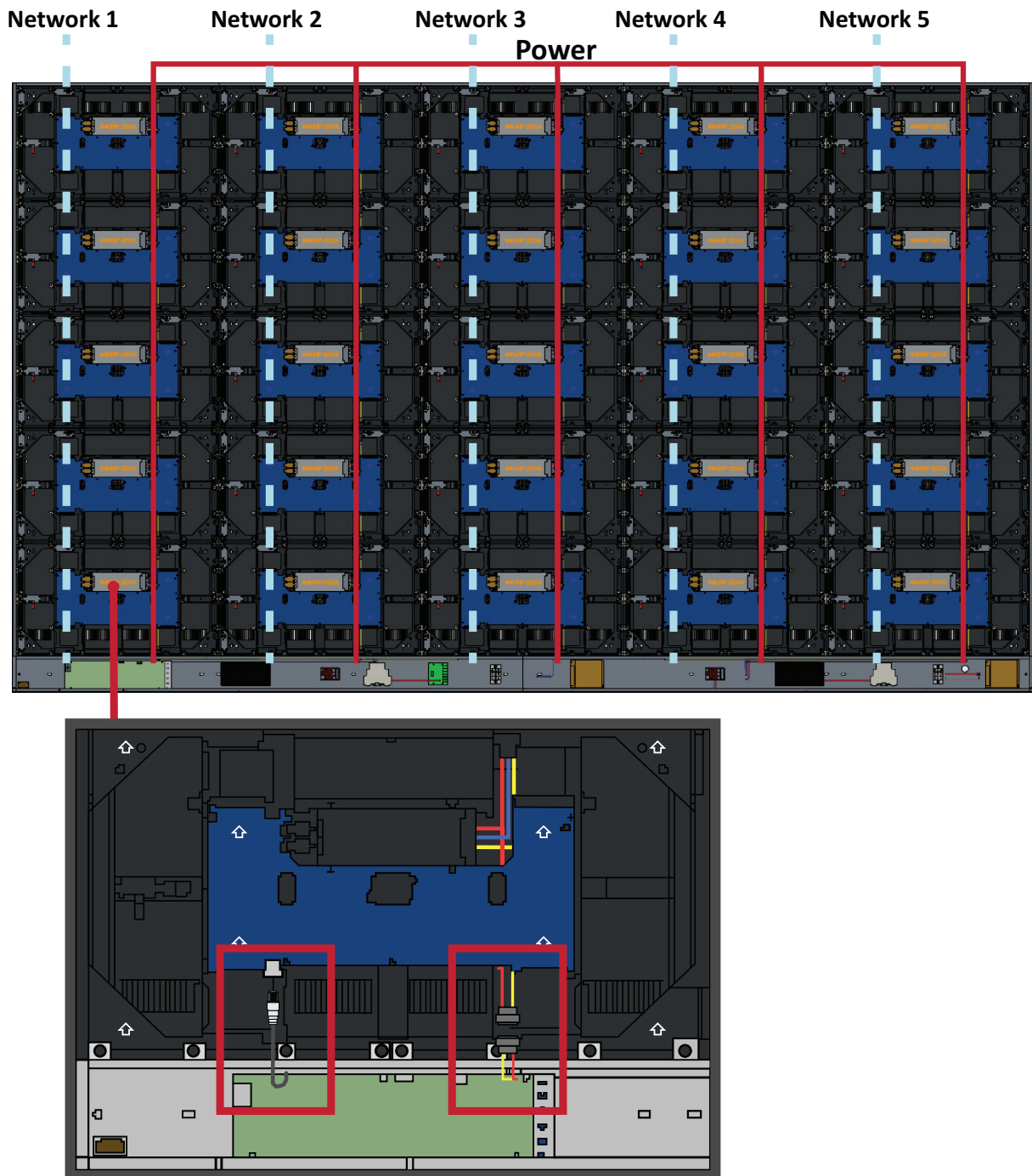

## Installing the LED Modules

Install each *LED Module* onto the *Cabinets*, being sure to match the corresponding numbers on the *Module* to the *Cabinet*.

! Please wear Anti-Static Gloves before installing the LED modules.

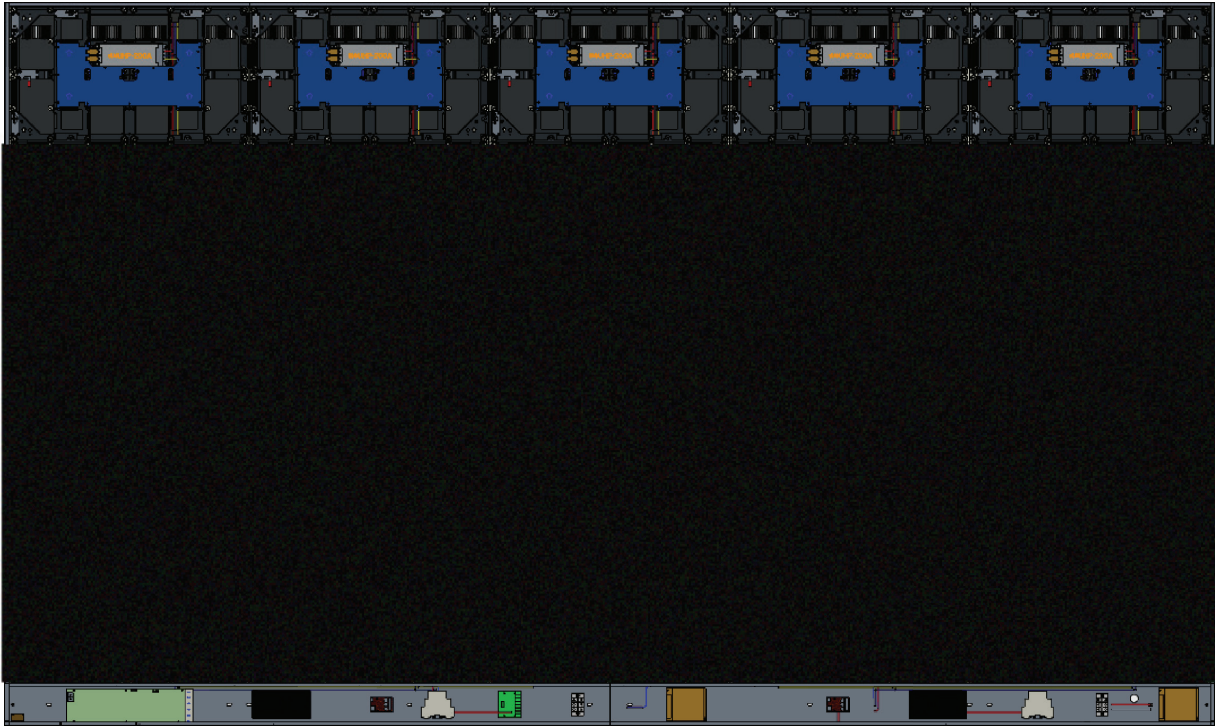

Ensure each *Module* is flush and that there is little to no gap between each.

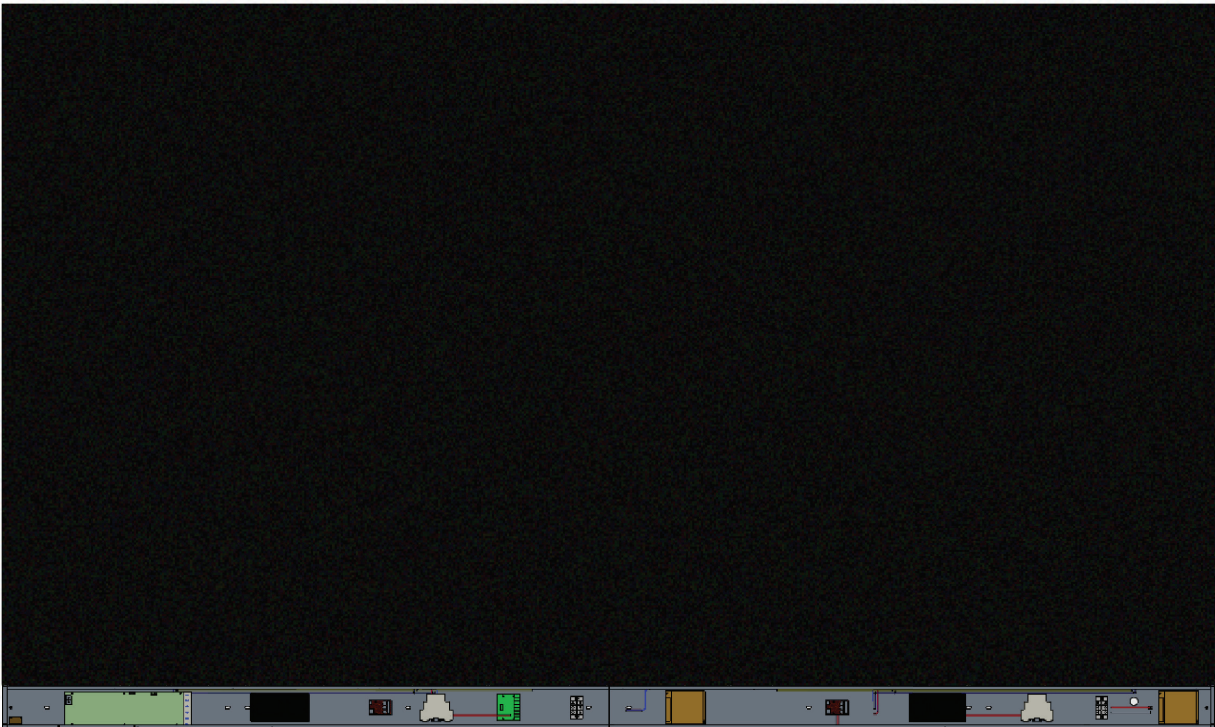



## Installing System Control Box Covers

There are three (3) System Control Box Covers: Left, Middle, and Right.



1. Begin by installing the *Right Cover* onto the *System Control Box*.

**NOTE:** Ensure the **Power Button** cable is connected to the *System Control Box* Power cable before securing the *Cover*.

2. After connecting the **Power Button** cable, ensure the *Right Cover* is properly aligned with the *System Control Box*; then secure it with the 12 provided screws (KM3x6mm).



3. Repeat the above steps for the *Middle* and *Left Cover*.



4. Your display is now ready for use.



**NOTE:** An installation video is available at:

<https://www.youtube.com/watch?v=cYmOUypjvWU&t=4s>

# Floor Stand Installation

The floor stand is an optional accessory. Follow the below instructions to install your LED Display onto the stand.

## Component List

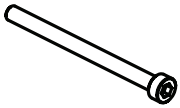
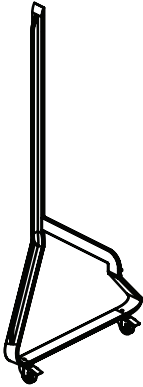
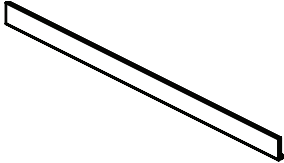
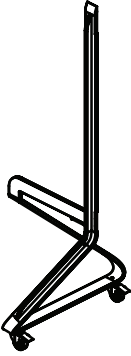
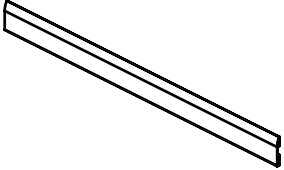
| Letter | Item  | Quantity | Description       |
|--------|---|----------|-------------------|
| A      |    | 1        | Hex Tool          |
| B      |    | 8        | M6 x 80mm Bolt    |
| C      |   | 1        | Left Support      |
| D      |  | 1        | Bottom Cross Beam |
| E      |  | 1        | Right Support     |
| F      |  | 1        | Top Cross Beam    |

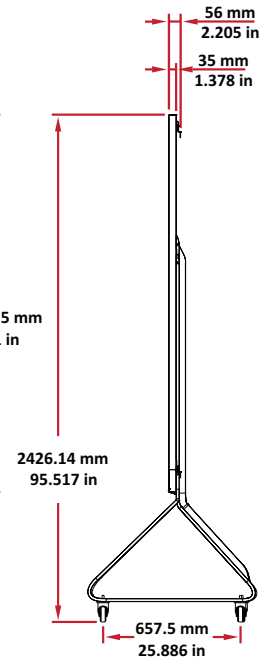
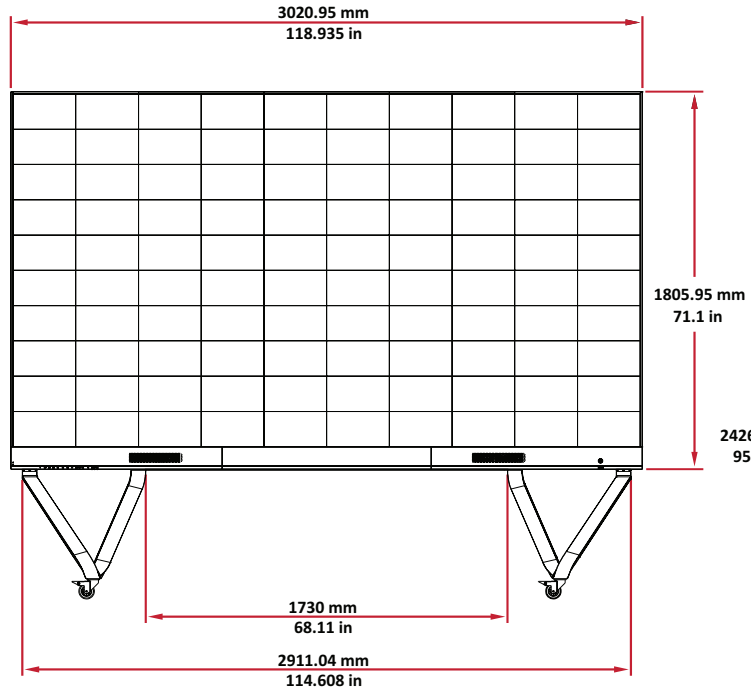
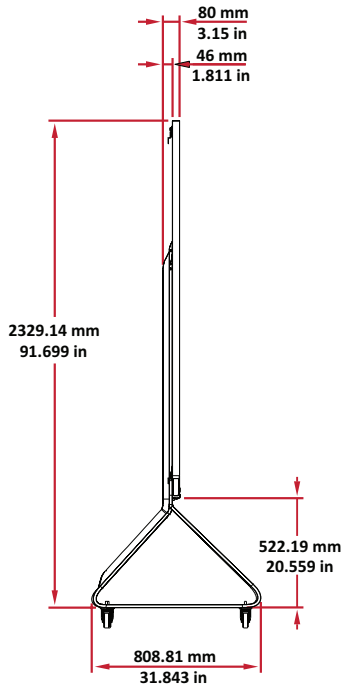
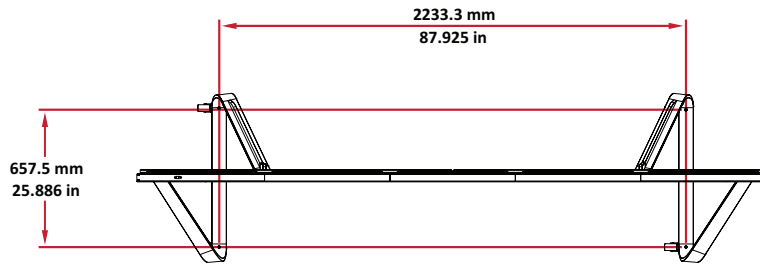

## Constructing the Floor Stand

1. Connect the *Left Support* to the *Bottom Cross Beam* with two (2) M6 x 80mm bolts.

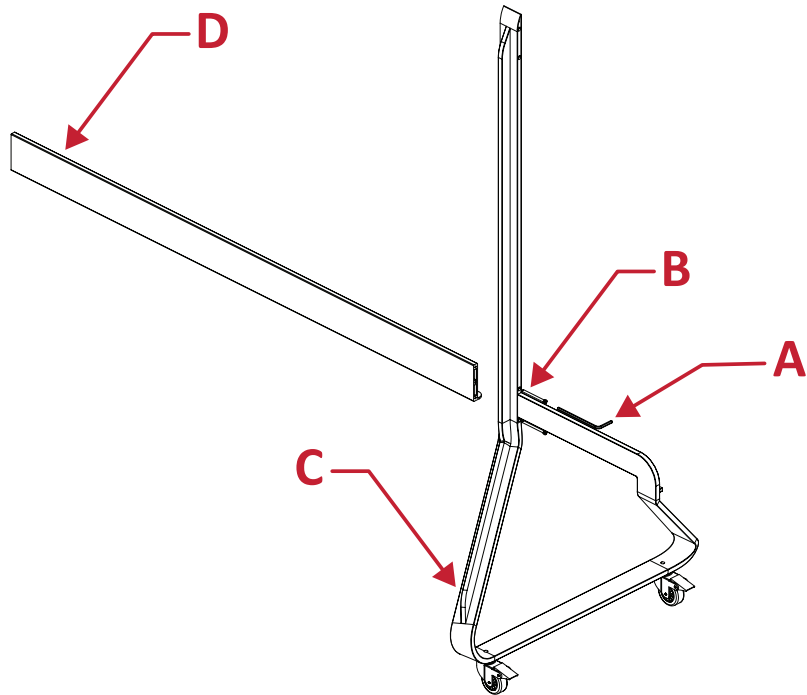

2. Connect the *Right Support* with the *Bottom Cross Beam* with two (2) M6 x 80mm bolts.

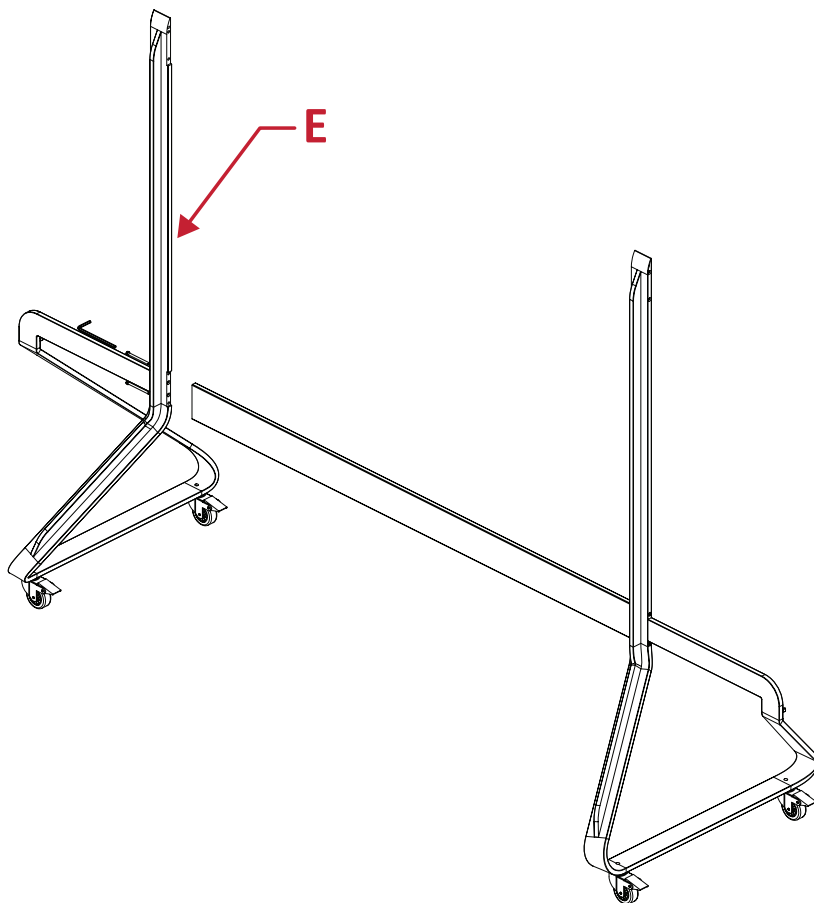

3. Connect the *Top Cross Beam* to the *Left* and *Right Supports* with four (4) M6 x 80mm bolts.

**NOTE:** Ensure the groove of the *Top Cross Beam* faces inwards.

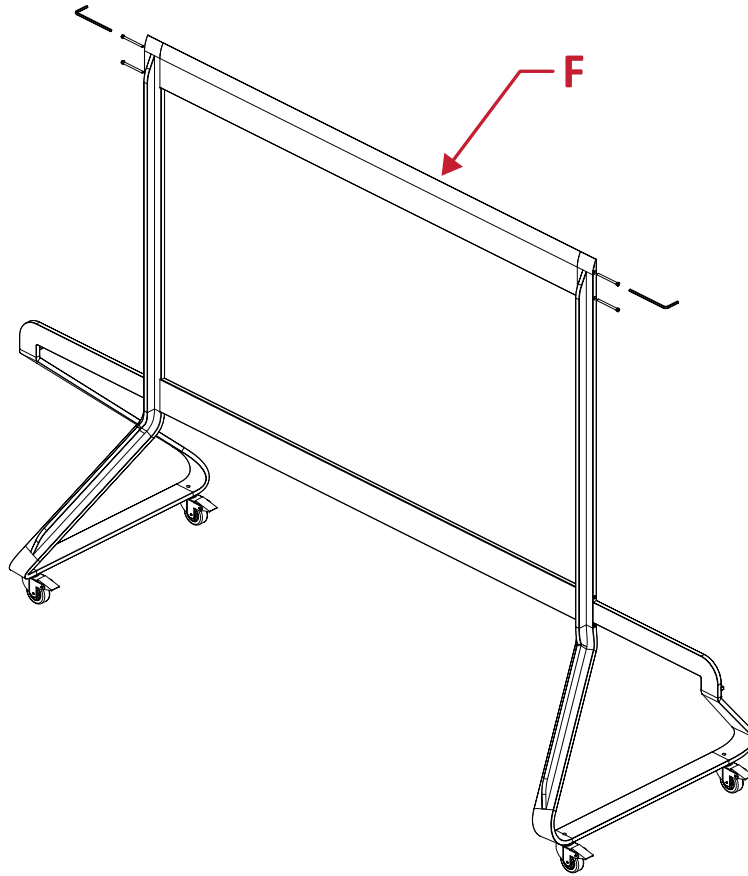

4. Ensure all bolts are tightened properly.

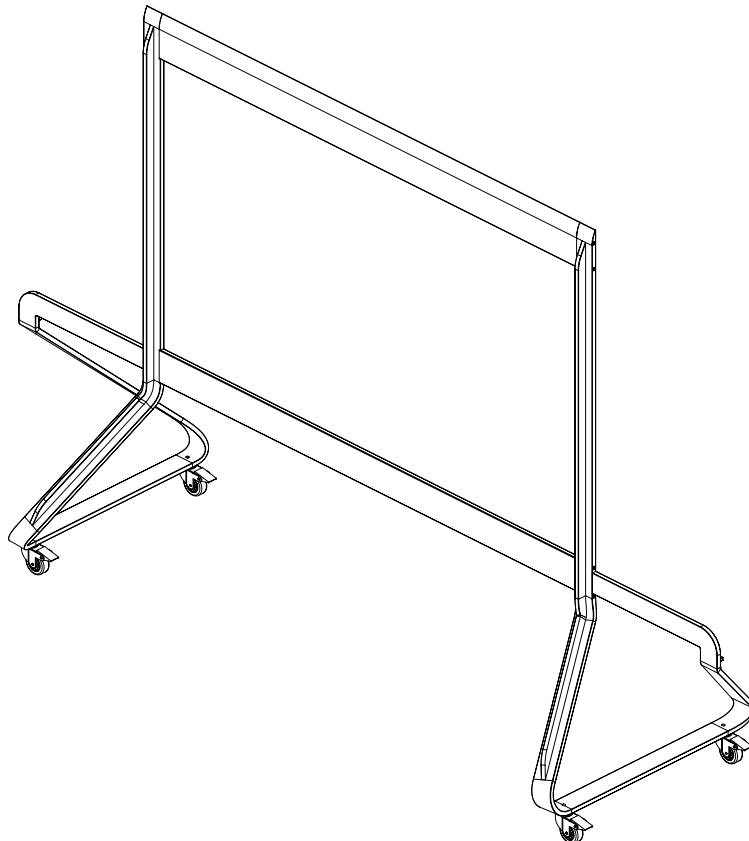



## Connecting the System Control Box to the Floor Base

1. Carefully unfold the *System Control Box* panel. Ensure the main system control board is on the left.

**NOTE:** Use caution as the *System Control Box* panel will be separated into two pieces, however the wires are connected.

2. Align the *System Control Box* to the eight (8) holes on the *Bottom Cross Beam* and secure it with eight (8) screws (M6x10mm).

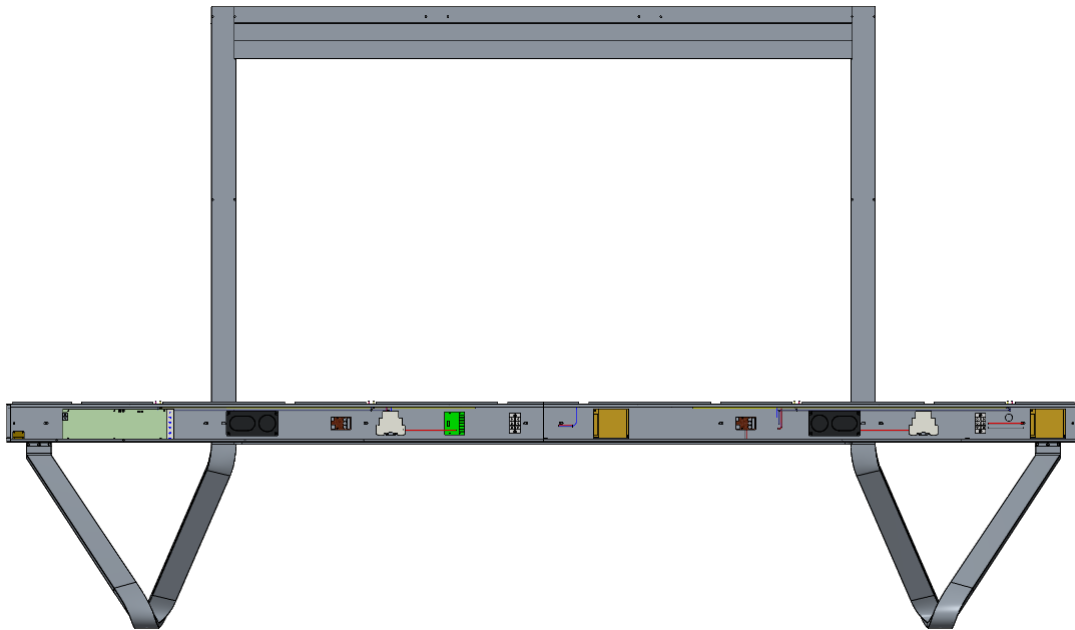

3. Install two (2) additional screws (M6x10mm) to connect the two halves of the *System Control Box*.

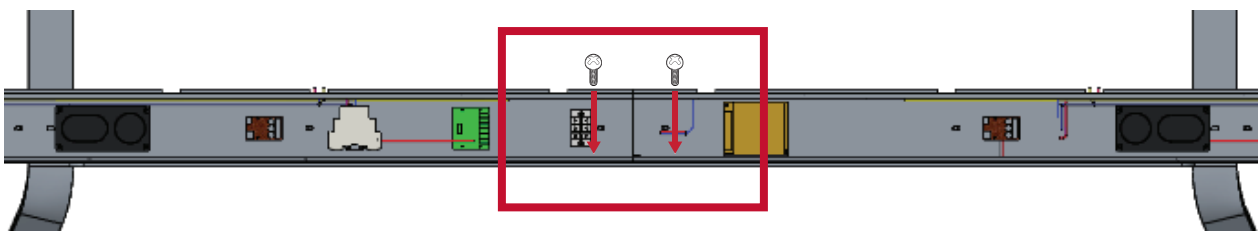

## Installing the Middle Cabinets

1. Ensure the three (3) *Mounting Brackets* on the rear of the three (3) *Middle Cabinets* are positioned as shown below:

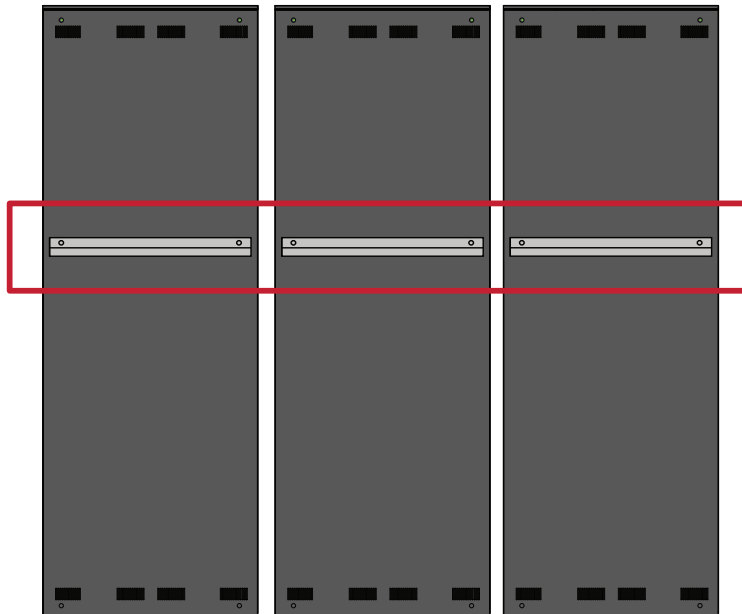

2. Carefully lift a *Cabinet* up onto the *Floor Stand*, securing the *Mounting Bracket* into the support channel of the *Top Cross Beam*. The bottom of the *Cabinet* will rest on the *Bottom Cross Beam*.

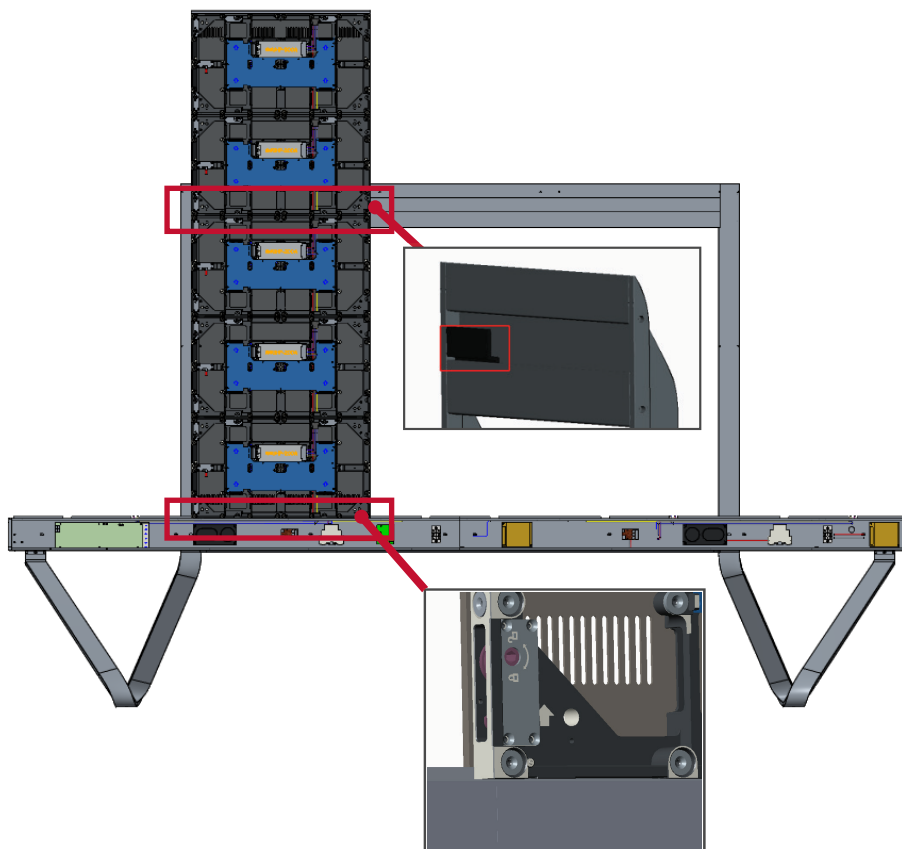

3. Secure the *Cabinet* to the *Support* with the provided screws (M6x10mm).

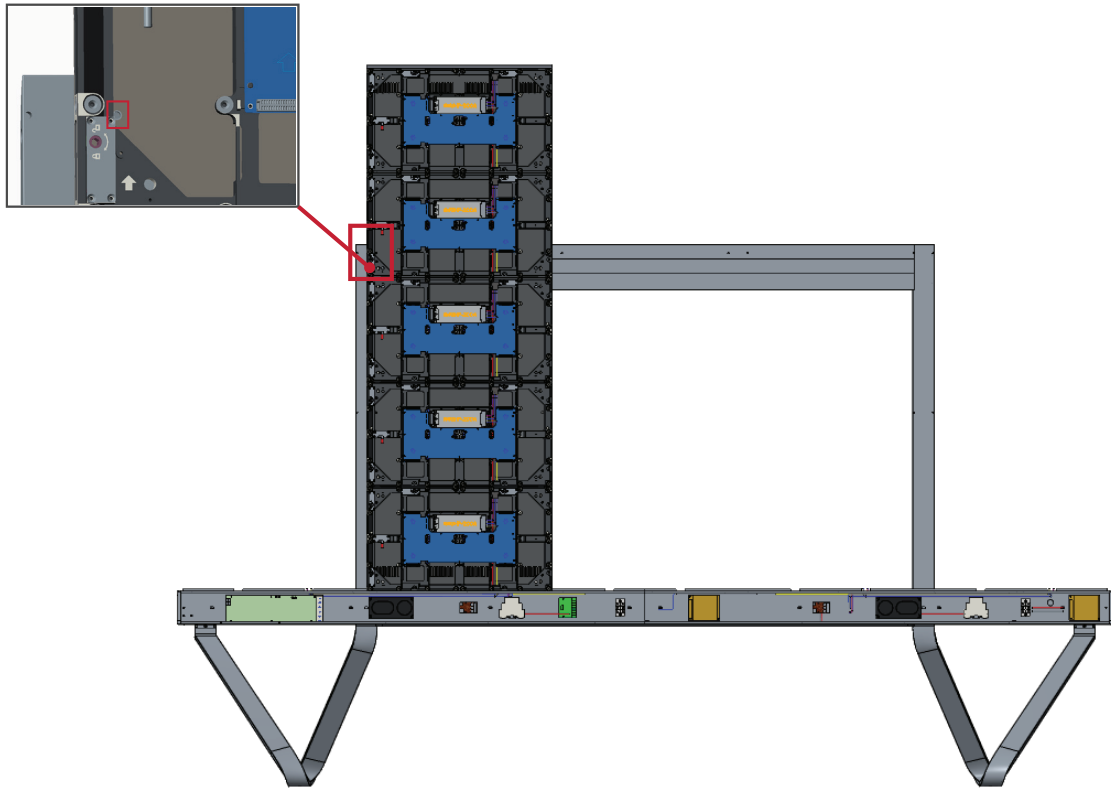

4. Push each *Locking Bolt* and lock each *Hook* with the hex tool to securely connect each cabinet together.

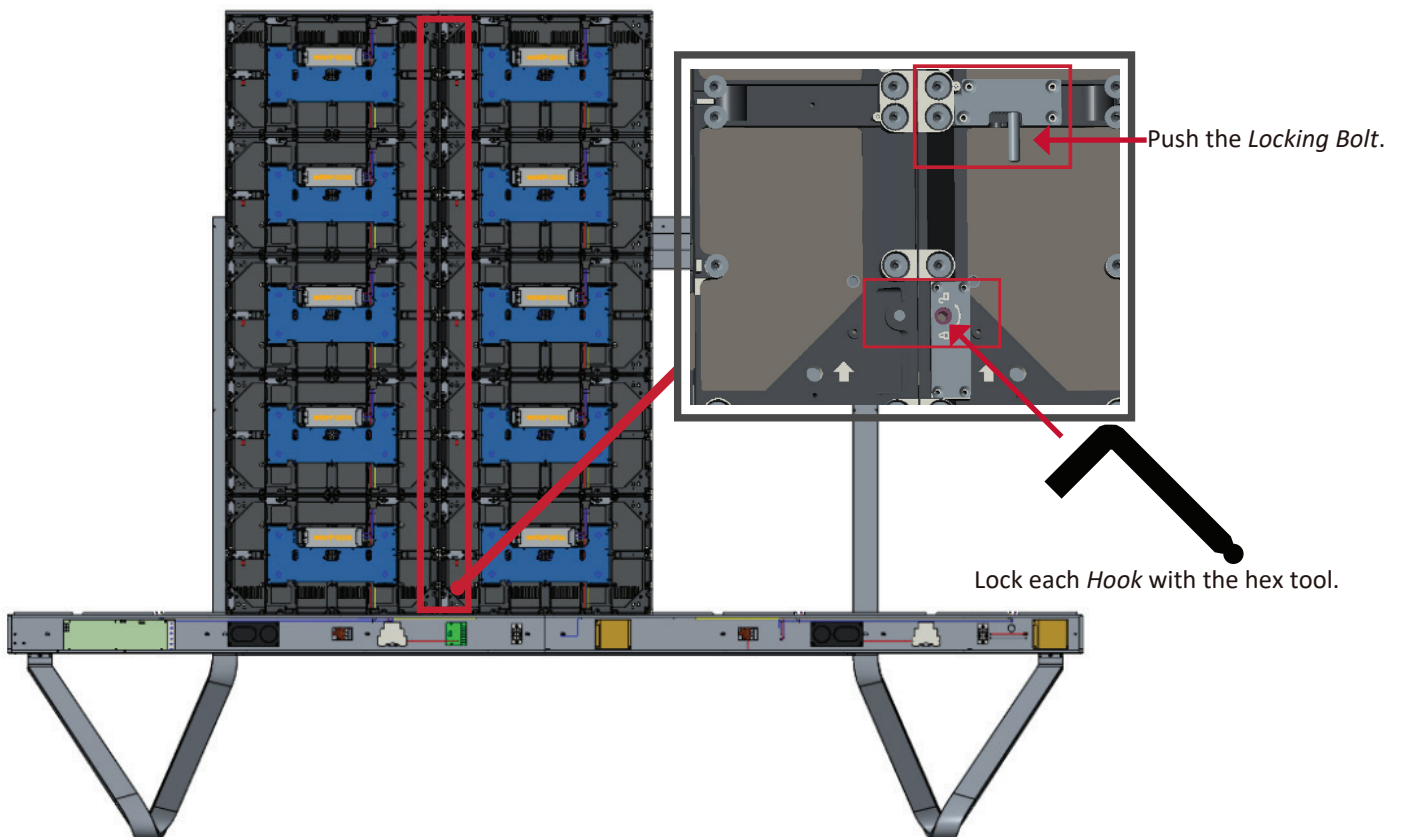

**NOTE:** There are five (5) *Locking Bolts* and 10 *Hooks* between each cabinet.

5. Repeat **Steps 2~4** for the remaining *Middle Cabinets*.

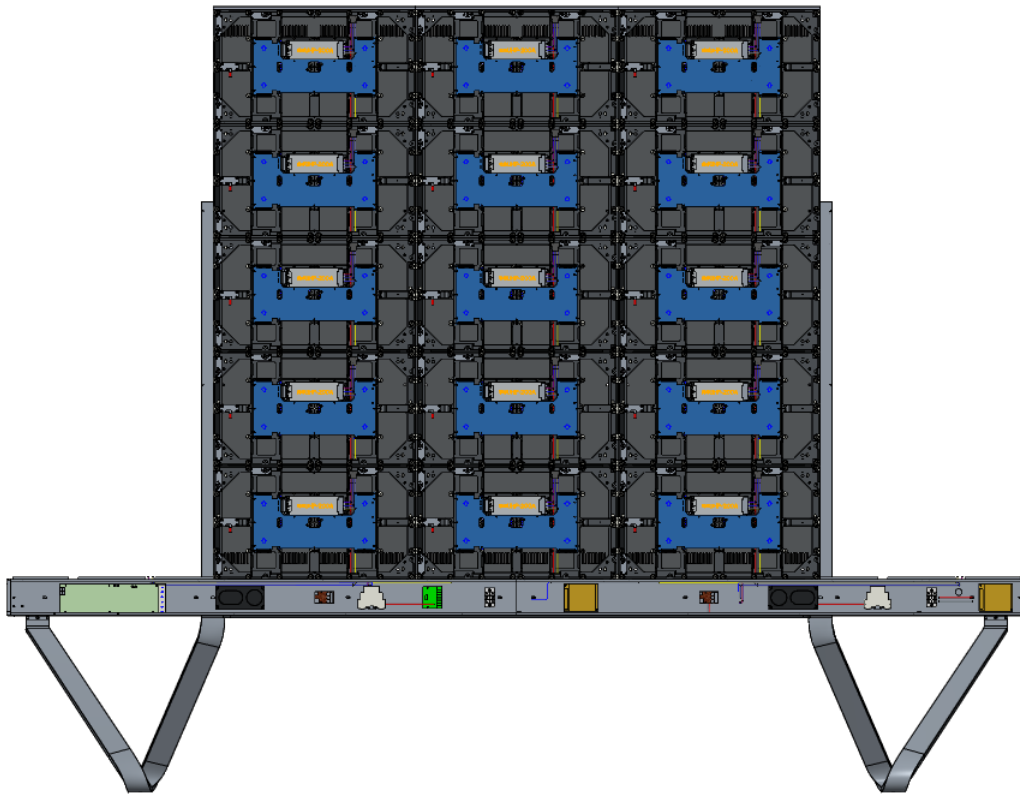

## Installing the Left and Right Cabinet

1. Carefully lift the *Left and Right Cabinet* up onto the *Floor Stand*, securing the *Mounting Bracket* into the support channel of the *Top Cross Beam*. The bottom of the *Cabinet* will rest on the *Bottom Cross Beam*.

**NOTE:** Ensure the holes of the *Cabinet* and the *System Control Box* are aligned.

2. Push each *Locking Bolt* and lock each *Hook* with the hex tool to securely connect the *Left and Right Cabinet* to the *Middle Cabinets*.

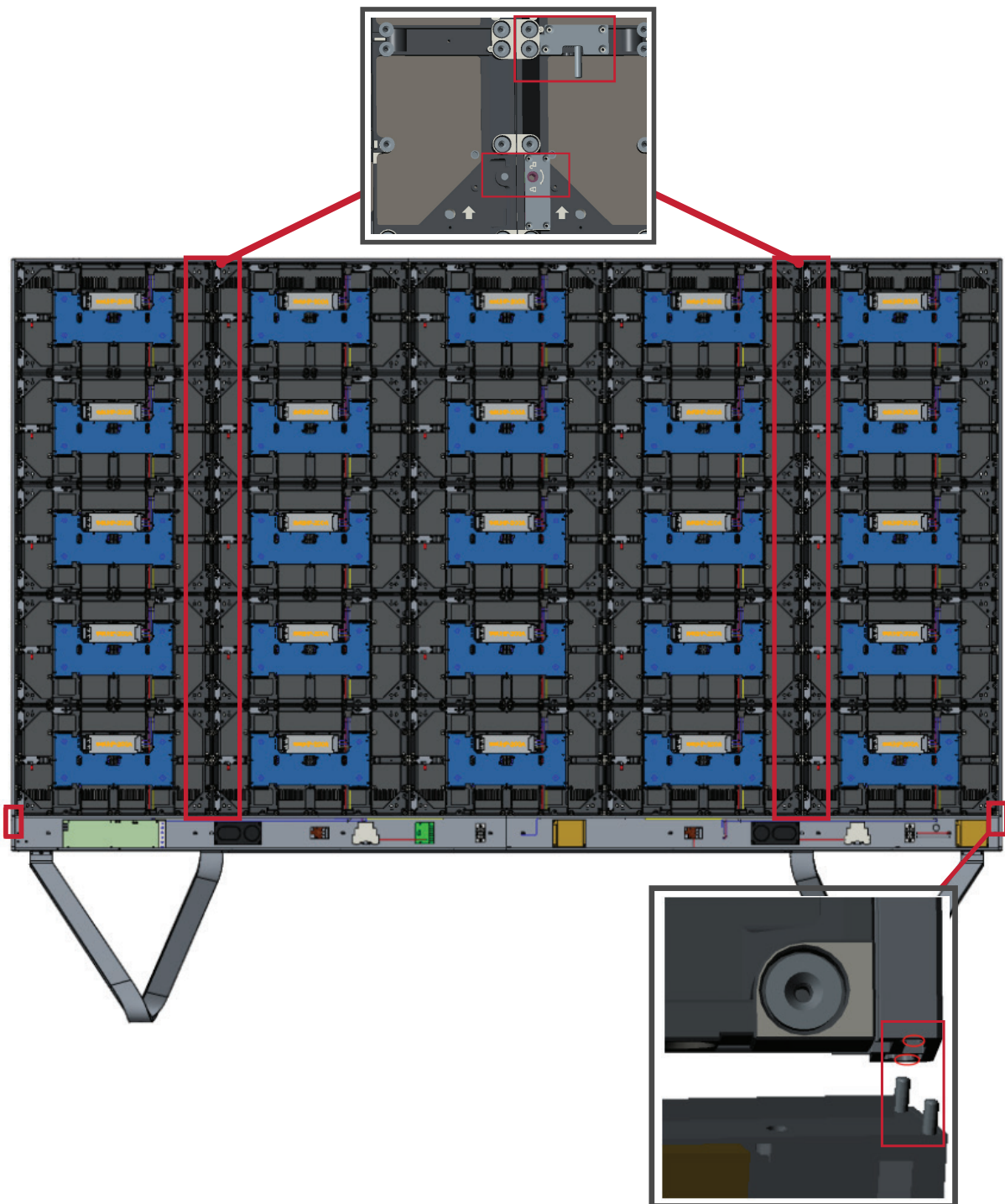

**NOTE:** There are five (5) *Locking Bolts* and 10 *Hooks* between each cabinet.

## Connect the Network and Power Cables

Connect the Network and Power cables of each *Cabinet* to the *System Control Box*.

**NOTE:** There are five (5) Network and five (5) Power cables to connect.

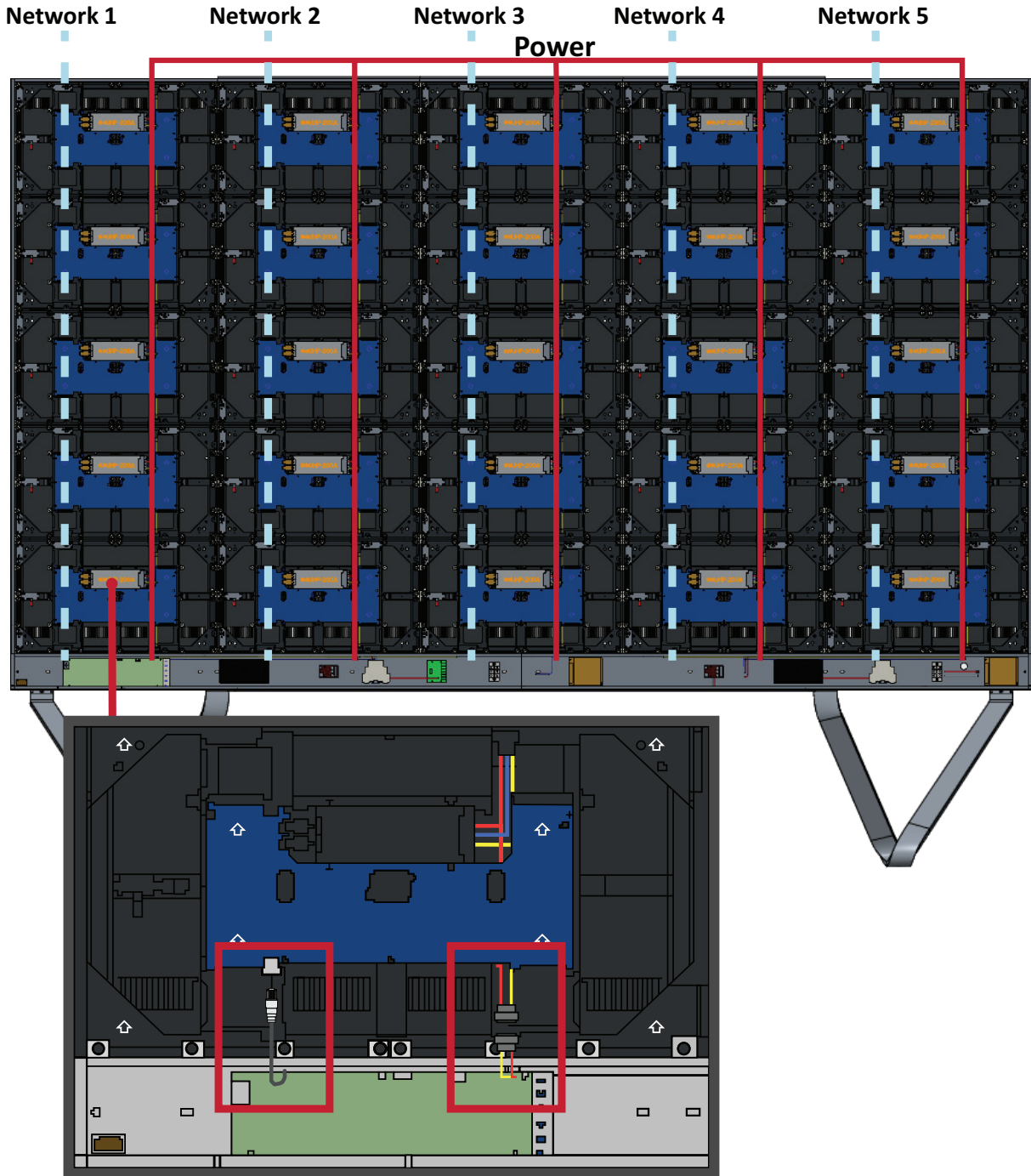



## Installing the LED Modules

Install each *LED Module* onto the *Cabinets*, being sure to match the corresponding numbers on the *Module* to the *Cabinet*. Ensure each *Module* is flush and that there is little to no gap between each.

! Please wear Anti-Static Gloves before installing the LED modules.



## Installing System Control Box Covers

There are three (3) System Control Box Covers: Left, Middle, and Right.



1. Begin by installing the *Right Cover* onto the *System Control Box*.

**NOTE:** Ensure the **Power Button** cable is connected to the *System Control Box* Power cable before securing the *Cover*.

2. After connecting the **Power Button** cable, ensure the *Right Cover* is properly aligned with the *System Control Box*; then secure it with the 12 provided screws (KM3x6mm).





3. Repeat the above steps for the *Middle* and *Left Cover*. Once all of the *Covers* are secured, your LED Display is ready to use.



**NOTE:** An installation video is available at:

<https://www.youtube.com/watch?v=cYmOUypjvWU&t=4s>

# > Making Connections

## Connecting to External Devices

### HDMI IN Connection

#### Media Player Connection

Connect an HDMI cable from your external device to an **HDMI IN** port on the LED display.

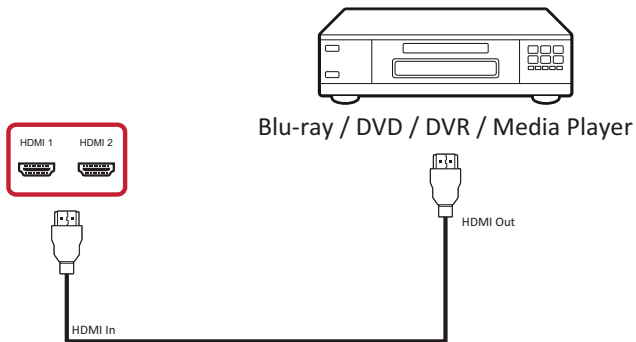

#### PC Connection

Connect an HDMI cable from your PC to an **HDMI IN** port on the LED display.

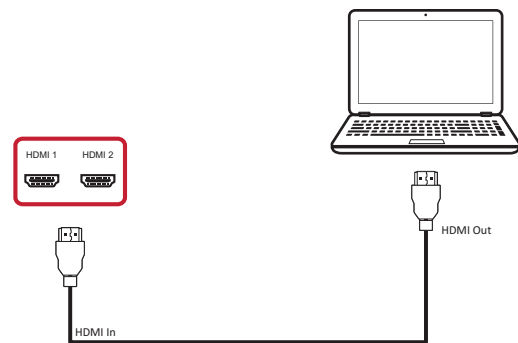

### Audio Connection

Connect an audio cable from your external audio device to the **Audio Out** port on the LED display.

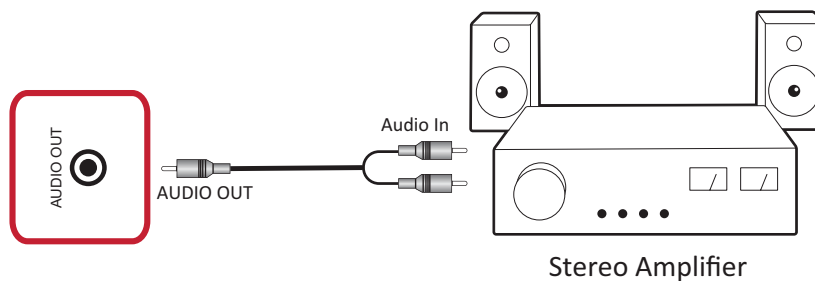

### Video Output Connection

To output video via an external display device, connect an HDMI cable to the **HDMI IN** port of your external display device, and the other end to the **HDMI OUT** port of your LED display.

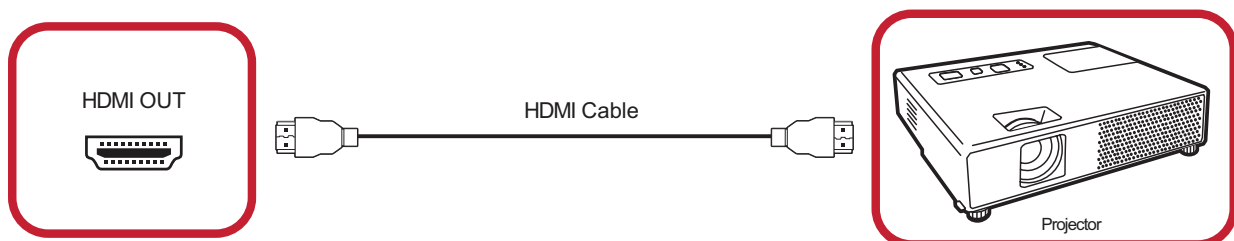

## USB and Networking Connections

Just like any PC, it is easy to connect various USB devices and other peripherals to your LED display.

### USB (Type A / Type B)

- USB Type A

Plug the USB device, cable, or storage drive into the **USB Type A** port.

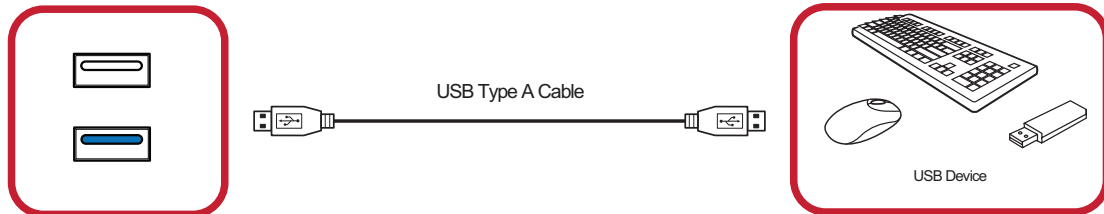

- USB Type B

Connect your PC with the LED display for debugging purposes via the **USB Type B** port on the LED display.

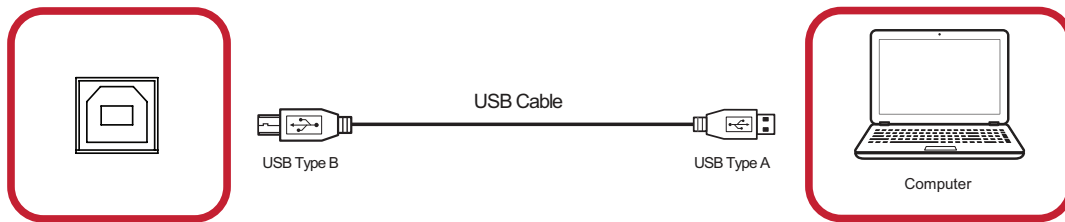

### Networking and Modem cables

Plug the network cable into the **LAN** port.

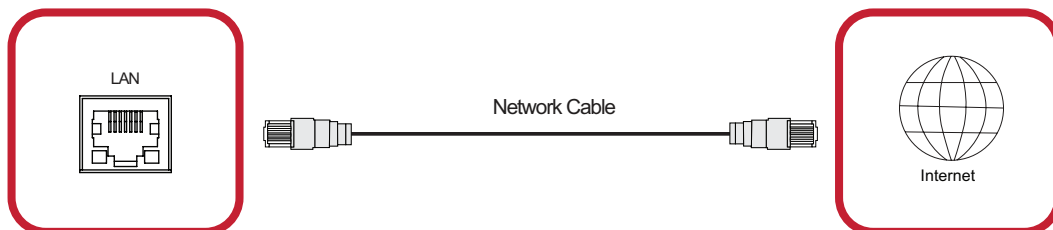

### **RS-232 Connection**

When you use a RS-232 serial cable to connect your LED display to an external computer and control system certain functions can be controlled remotely such as: Power On/Off, Volume adjustment, Input select, Brightness, and more.

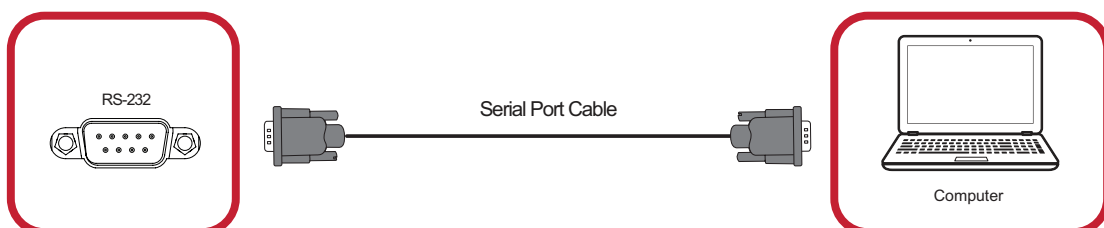

# > Using Your Display

## Powering On/Off your LED Display

1. Ensure the power cord is connected and plugged into a power outlet.



The **⏻ Power** button is located on the front of the unit.

2. Press the **⏻ Power** button to turn on the LED display.
3. To turn the LED display off, press the **⏻ Power** button again.

# Home Screen

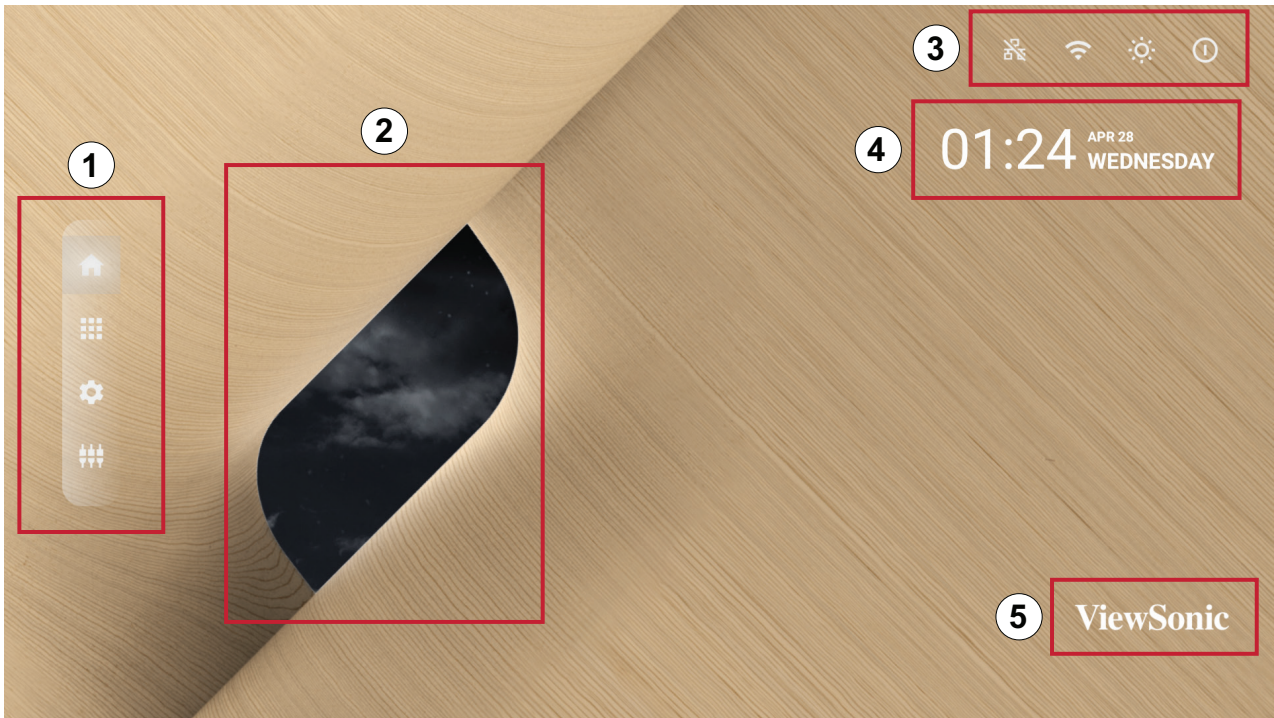

| Number | Item                  | Description   |
|--------|-----------------------|---|
| 1      | Main Menu             | Access the <b>Home Screen, APP Center, Settings, and Input Source.</b>  |
| 2      | Time of Day Indicator | The sky will change over the day between morning, noon, afternoon, and night.   |
| 3      | Quick Access          | Quick access to LAN, Wi-Fi, Brightness, and Power.<br><b>NOTE:</b> Only supported by keyboard and mouse.  |
| 4      | Date & Time           | Automatic time adjustment, time zone selection, and 24-hour format can all be adjusted on page 64.<br>The Date & Time can also be hidden from the Home Screen under:<br><b>Settings &gt; Display &gt; Launcher Settings</b> |
| 5      | ViewSonic Logo        | The logo can be hidden from the Home Screen under:<br><b>Settings &gt; Display &gt; Launcher Settings</b>   |

# Navigating the Home Screen

## Remote Control

The remote control can be used to easily navigate the Home Screen. When using the remote control, ensure it is kept within the IR receiver range as shown below:

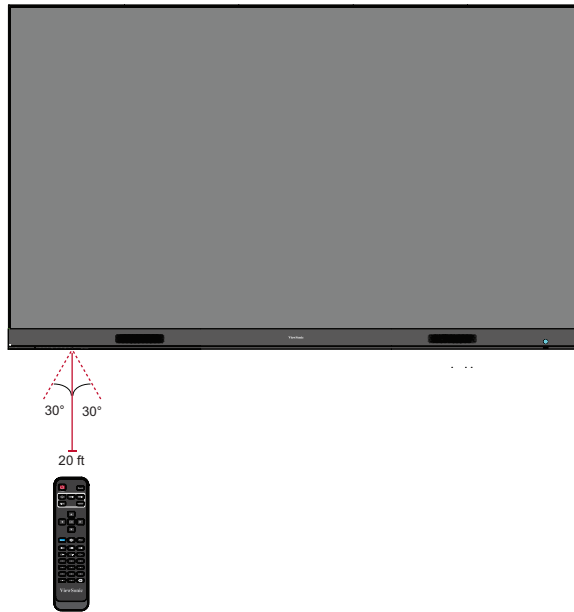

## Keyboard and Mouse

When connected to the USB Type-A port of the display, a keyboard and mouse can also be used to navigate the Home Screen.

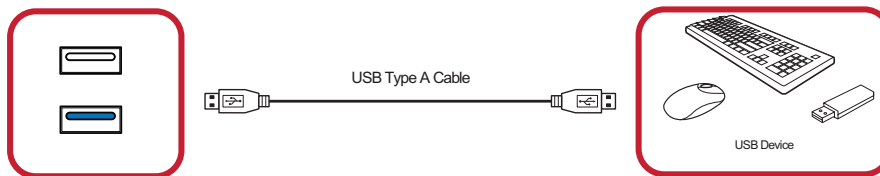

The mouse pointer will appear as an orange dot on the display when used:

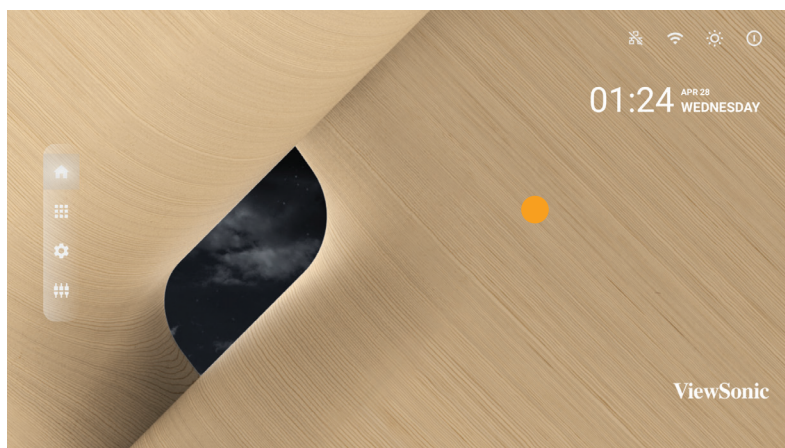









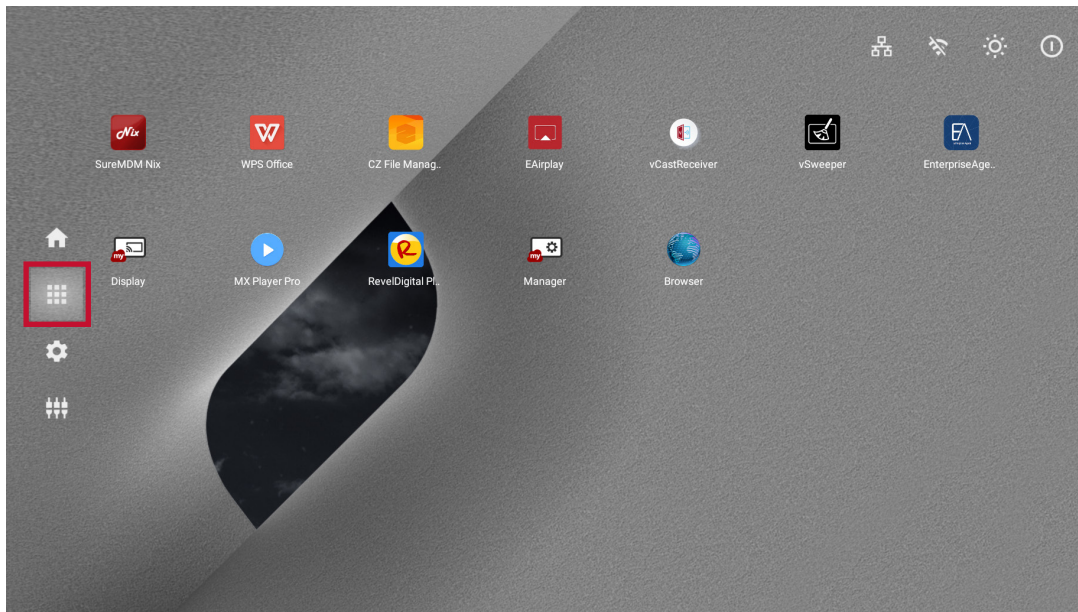



- The left mouse button will confirm actions.
- The right mouse button will go back to the previous layer.
- Keyboard shortcuts and hot keys are also supported, including: audio adjustment, mute, and back to the Home Screen.



# APP Center

Installed applications will be in the APP Center.



| Icon  | Name                  | Description                                       |
|---|-----------------------|---|
|    | Browser               | Web browser                                       |
|  | Display               | Wirelessly mirror your desktop                    |
|  | EAirplay              | AirPlay mirroring                                 |
|  | EnterpriseAgent       | Device management                                 |
|  | File Manager          | File explorer                                     |
|  | Manager               | Remote device management                          |
|  | Revel Digital Signage | Manage digital signage                            |
|  | SureMDM Nix           | Secure, monitor, and manage devices               |
|  | WPS Office            | Create documents, spreadsheets, and presentations |
|  | vCastReceiver         | Receive casted content from devices               |
|  | vSweeper              | Clear up storage space                            |

**NOTE:** Preloaded applications are subject to change without notice.

# Input Source

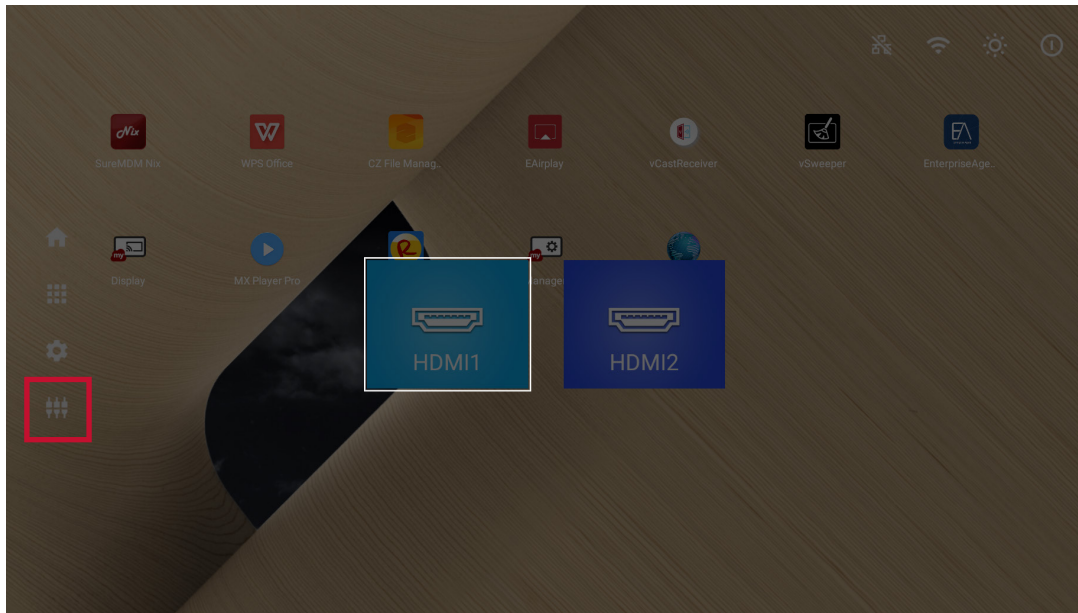

The display supports two input sources: **HDMI 1** and **HDMI 2**.

**NOTE:** Both input sources support HDMI 2.0.



# Settings

Adjust and view the display's settings.

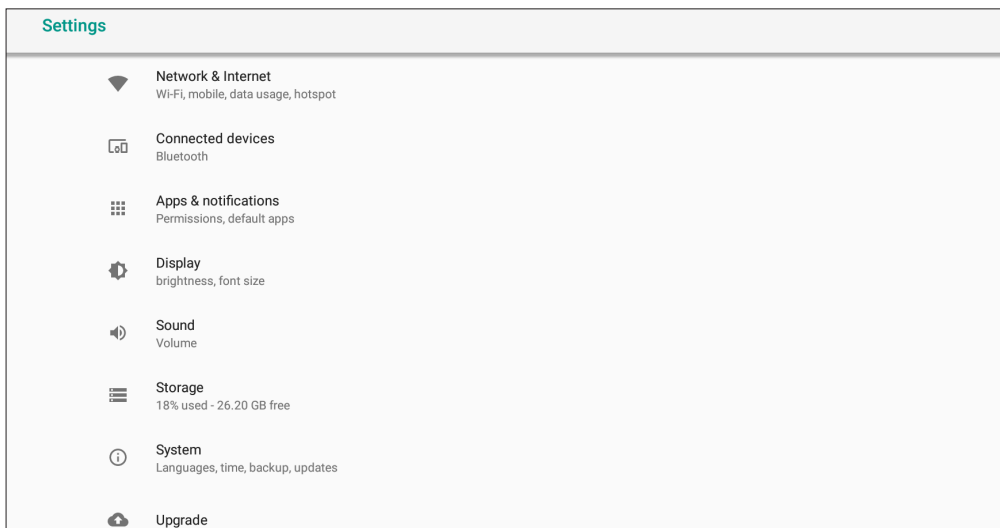

| Menu                            | Description   |
|---------------------------------|---|
| <b>Network &amp; Internet</b>   | View and adjust Wi-Fi, Data Usage, Ethernet, Potable Hotspot, and VPN   |
| <b>Connected Devices</b>        | View and adjust Connected Devices   |
| <b>Apps &amp; Notifications</b> | View and adjust App Info., Notifications, App Permissions, Default Apps, and Special App Access                             |
| <b>Display</b>                  | View and adjust Brightness Level, Ambient Light Sensor, Font Size, Startup & Shutdown, Input Setting, and Launcher Settings |
| <b>Sound</b>                    | View and adjust Media Volume  |
| <b>Storage</b>                  | View and adjust Device Storage  |
| <b>System</b>                   | View and adjust Languages & Input, Date & Time, Reset, and About Device   |
| <b>Upgrade</b>                  | View and adjust OTA Upgrade and Local Update  |

## Settings Menu Tree

| Main Menu          | Sub-menu               | Menu Option          |                            |     |     |
|--------------------|------------------------|----------------------|----------------------------|-----|-----|
| Network & Internet | Wi-Fi                  | Wi-Fi                | On                         |     |     |
|                    |                        |                      | Off                        |     |     |
|                    |                        | Wi-Fi List           | Add Network                |     |     |
|                    |                        | Wi-Fi Preference     | Open Network Notification  |     | On  |
|                    |                        |                      |                            |     | Off |
|                    |                        |                      | Keep Wi-Fi on During Sleep |     |     |
|                    |                        | Advanced             |                            |     |     |
|                    | Data Usage             | Wi-Fi Data Usage     |                            |     |     |
|                    |                        | Network Restrictions | Meter Wi-Fi Network        | On  |     |
|                    |                        |                      |                            | Off |     |
|                    | Ethernet               | Ethernet             | On                         |     |     |
|                    |                        |                      | Off                        |     |     |
|                    |                        | Ethernet IP Mode     |                            |     |     |
|                    |                        | Ethernet Details     |                            |     |     |
| Portable Hotspot   | Portable Wi-Fi Hotspot | On                   |                            |     |     |
|                    |                        | Off                  |                            |     |     |
|                    | Set up Wi-Fi Hotspot   |                      |                            |     |     |
| VPN                |                        |                      |                            |     |     |
| Connected Devices  | Connected Devices      | On                   |                            |     |     |
|                    |                        | Off                  |                            |     |     |

| Main Menu                       | Sub-menu        | Menu Option              |                                 |
|---------------------------------|-----------------|--------------------------|---------------------------------|
| <b>Apps &amp; Notifications</b> | App Info.       | Installed Apps           | Disable                         |
|                                 |                 |                          | Force Stop                      |
|                                 | Notifications   | Allow Notifications Dots | On                              |
|                                 |                 |                          | Off                             |
|                                 |                 | On the Lock Screen       | Don't Show Notifications at All |
|                                 |                 |                          | Show All Notification's Content |
|                                 | App Permissions | Body Sensors             |                                 |
|                                 |                 | Calendar                 |                                 |
|                                 |                 | Camera                   |                                 |
|                                 |                 | Contacts                 |                                 |
|                                 |                 | Location                 |                                 |
|                                 |                 | Microphone               |                                 |
|                                 |                 | Phone                    |                                 |
|                                 |                 | SMS                      |                                 |
|                                 |                 | Storage                  |                                 |
|                                 | Default Apps    | Assist & Voice Input     |                                 |
|                                 |                 | Browser                  |                                 |
|                                 |                 | Home                     |                                 |
|                                 |                 | Opening Links            |                                 |

| Main Menu                       | Sub-menu               | Menu Option              |                   |                            |
|---------------------------------|------------------------|--------------------------|-------------------|----------------------------|
| <b>Apps &amp; Notifications</b> | Special App Access     | Battery Optimization     |                   |                            |
|                                 |                        | Device Admin Apps        |                   |                            |
|                                 |                        | Do No Disturb Access     |                   |                            |
|                                 |                        | Display Over other Apps  |                   |                            |
|                                 |                        | VR Helper Services       |                   |                            |
|                                 |                        | Modify System Settings   |                   |                            |
|                                 |                        | Notification Access      |                   |                            |
|                                 |                        | Picture-in-Picture       |                   |                            |
|                                 |                        | Premium SMS Access       |                   |                            |
|                                 |                        | Unrestricted Data Access |                   |                            |
|                                 |                        | Usage Access             |                   |                            |
|                                 |                        | Install Unknown Apps     |                   |                            |
| <b>Display</b>                  | Brightness Level       | (-/+ , 1~8)              |                   |                            |
|                                 | Ambient Light Sensor   | On                       |                   |                            |
|                                 |                        | Off                      |                   |                            |
|                                 | Font Size              | (-/+ , 1~4)              |                   |                            |
|                                 | Other Display Settings | Display Settings         | Custom Resolution | W: 800~1920<br>H: 600~1080 |
|                                 |                        |                          | Custom DPI        | (-/+ , 100~240)            |
|                                 |                        |                          | Custom Wallpaper  |                            |
| Boot Logo Settings              |                        |                          | Video Logo        |                            |

| Main Menu         | Sub-menu             | Menu Option             |                     |         |  |
|-------------------|----------------------|-------------------------|---------------------|---------|--|
| Display           | Startup & Shutdown   | Last Shutdown Channel   |                     |         |  |
|                   |                      | Default Startup Channel | Home                |         |  |
|                   |                      |                         | HDMI 1              |         |  |
|                   |                      |                         | HDMI 2              |         |  |
|                   |                      |                         | APP (Display)       |         |  |
|                   |                      |                         | APP (vCastReceiver) |         |  |
|                   |                      | Standby Mode            | Hibernate           |         |  |
|                   |                      |                         | Sleep               |         |  |
|                   |                      | Splash Screen           | ViewSonic           |         |  |
|                   | Black                |                         |                     |         |  |
|                   | Blue                 |                         |                     |         |  |
|                   | Input Setting        | Input Alias             | HDMI 1              | Display |  |
|                   |                      |                         |                     | Hide    |  |
|                   |                      | HDMI 2                  | Display             |         |  |
|                   |                      |                         | Hide                |         |  |
|                   | Signal Source Detect | HDMI                    | Enable              |         |  |
|                   |                      |                         | Disable             |         |  |
| Launcher Settings | ViewSonic Logo       | On                      |                     |         |  |
|                   |                      | Off                     |                     |         |  |
|                   | Date & Time          | On                      |                     |         |  |
|                   |                      | Off                     |                     |         |  |
|                   | Theme                |                         |                     |         |  |
| Sound             | Media Volume         | (-/+ , 0~100)           |                     |         |  |
| Storage           | Device Storage       | Internal Shared Storage | Storage Manager     | On      |  |
|                   |                      |                         |                     | Off     |  |
|                   |                      |                         | Photos & Videos     |         |  |
|                   |                      |                         | Music & Audio       |         |  |
|                   |                      |                         | Games               |         |  |
|                   | Movie & TV           |                         |                     |         |  |
| Portable Storage  |                      |                         |                     |         |  |

| Main Menu      | Sub-menu           | Menu Option            |                                |  |
|----------------|--------------------|------------------------|--------------------------------|--|
| System         | Language & Input   | Languages              |                                |  |
|                |                    | Virtual Keyboard       | Remote Controller Input Method |  |
|                |                    |                        | Manage Keyboards               |  |
|                |                    | Physical Keyboard      | Hi Keyboard                    |  |
|                |                    |                        | Hi Keypad                      |  |
|                |                    |                        | Keyboard Assistance            |  |
|                |                    |                        | Gestures                       |  |
|                |                    | Advanced               | Preferred Engine               |  |
|                |                    |                        | Language                       |  |
|                |                    |                        | Speech Rate                    |  |
|                | Pitch              |                        |                                |  |
|                | Date & Time        | Automatic Date & Time  | On                             |  |
|                |                    |                        | Off                            |  |
|                |                    | Select Time Zone       |                                |  |
|                | Use 24-hour Format | On                     |                                |  |
|                |                    | Off                    |                                |  |
|                | Reset              | Network Settings Reset |                                |  |
|                |                    | Reset App Preferences  |                                |  |
|                |                    | Factory Data Reset     |                                |  |
|                | About Device       | Status                 |                                |  |
|                |                    | Legal Information      |                                |  |
| Model          |                    |                        |                                |  |
| Kernel Version |                    |                        |                                |  |
| Build Number   |                    |                        |                                |  |
| Total Time     |                    |                        |                                |  |
| Upgrade        | OTA Upgrade        | OTA Cloud Server       |                                |  |
|                | Local Update       | sda1                   |                                |  |
|                |                    | SDcard                 |                                |  |

# Network & Internet

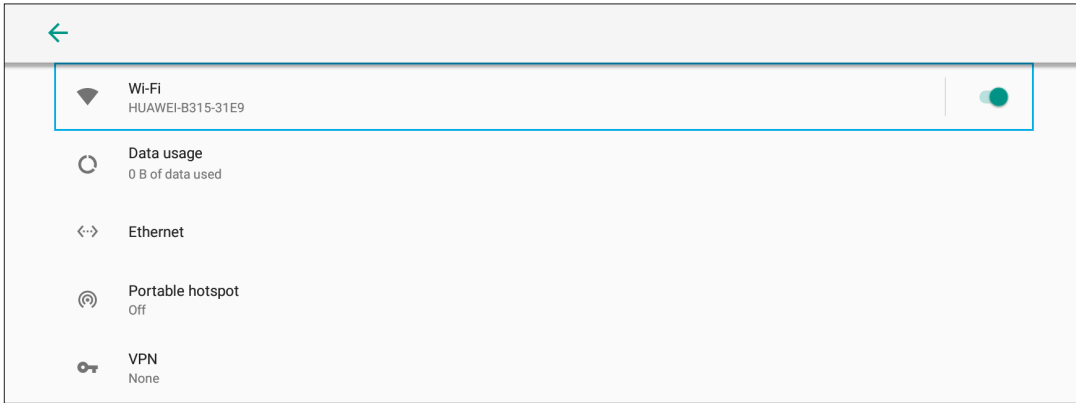

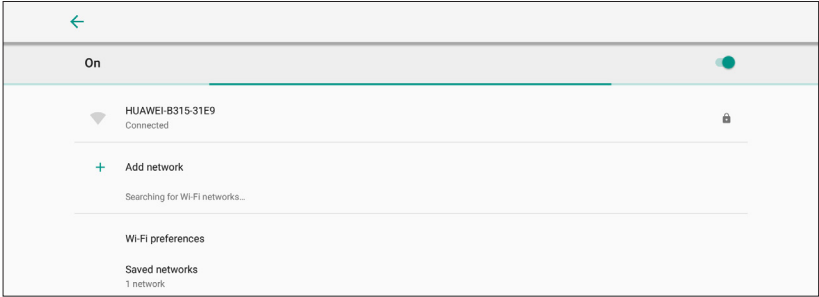
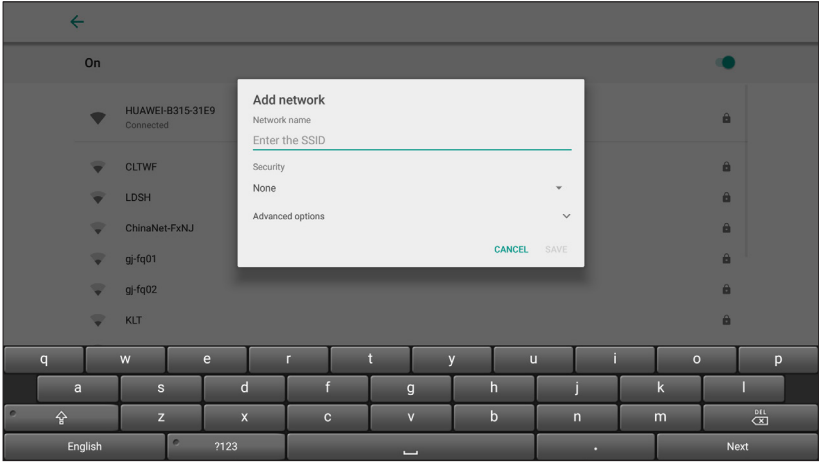
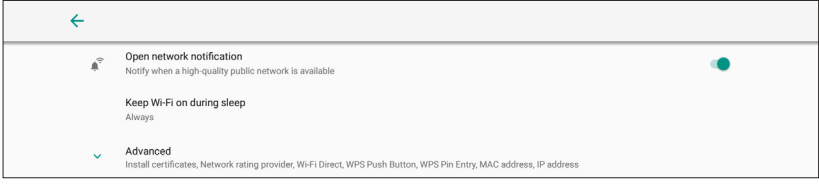
| Sub-menu            | Description  |
|---------------------|--|
| <p><b>Wi-Fi</b></p> | <p>Select <b>Wi-Fi</b> to enter the Wi-Fi selection interface. Then select the desired Wi-Fi network and enter the password.</p>  <p>You can select <b>Add Network</b> in the Wi-Fi selection screen to manually add a Wi-Fi network.</p>  <p>Select <b>Wi-Fi Preferences</b> to view Wi-Fi usage preferences, Wi-Fi connection tips, etc.</p>  |

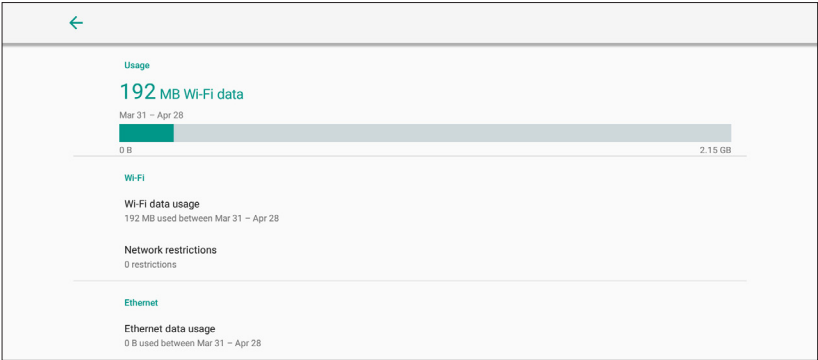
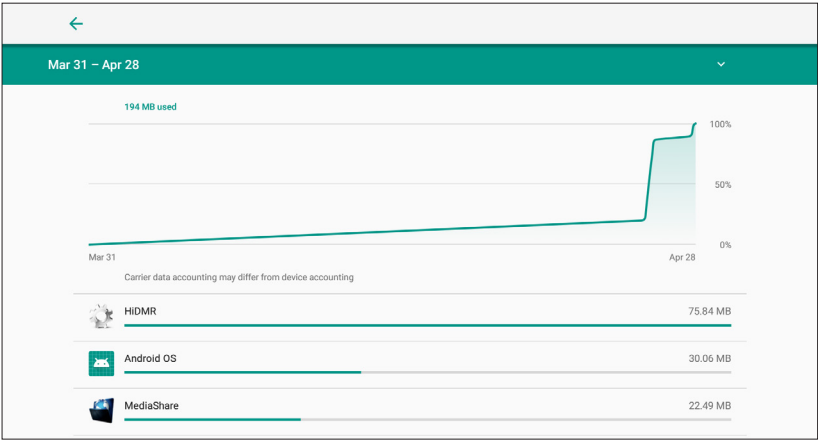
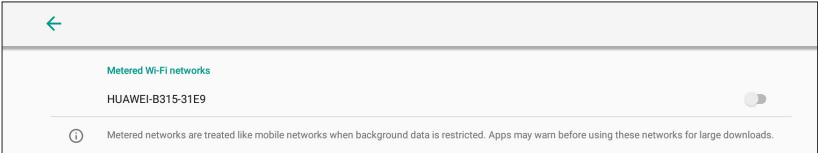
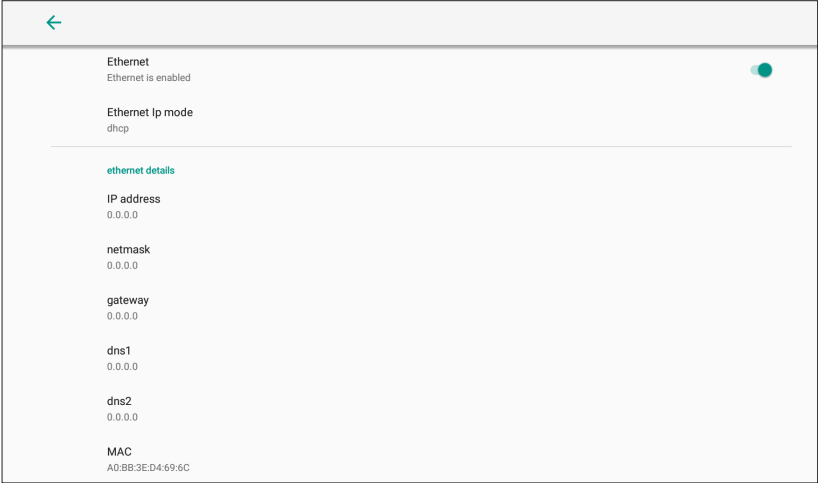
| Sub-menu            | Description   |
|---------------------|---|
| <h2>Data Usage</h2> | <p>Select <b>Data Usage</b> to review data usage and network restrictions.</p>  <p>Specific App's traffic can be reviewed as well in <b>Wi-Fi Data Usage</b>.</p>  <p>Restrictions can be placed on specific network traffic under <b>Network Restrictions</b>.</p>  |
| <h2>Ethernet</h2>   | <p>Select <b>Ethernet</b> to enable/disable Ethernet, review DNS, and IP mode.</p>    |

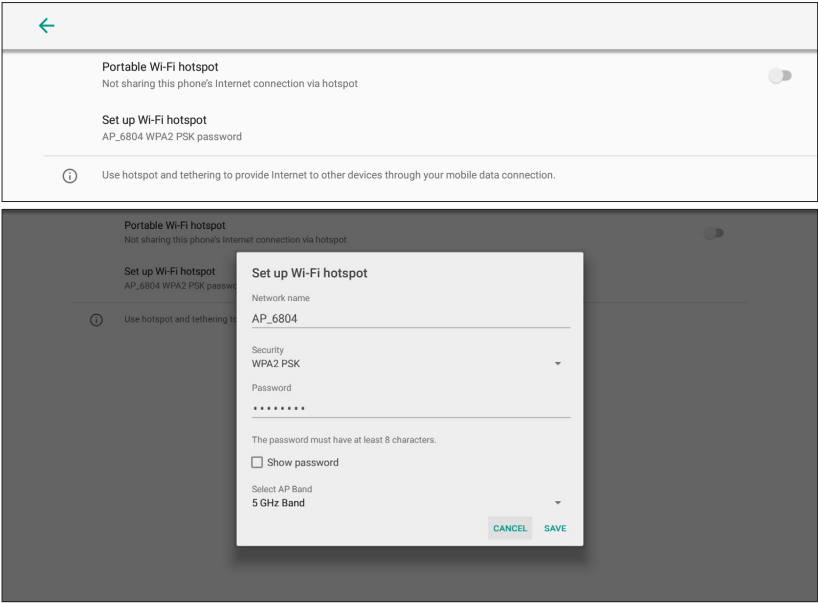
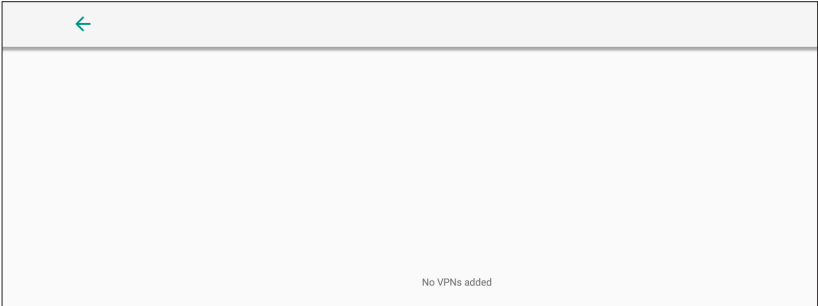

| Sub-menu   | Description  |
|--|--|
| <p style="text-align: center;"><b>Portable Hotspot</b></p> | <p>Enable/disable Portable Wi-Fi Hotspot under <b>Portable Hotspot</b>.</p>  |
| <p style="text-align: center;"><b>VPN</b></p>              | <p>Review and add VPNs.</p>   |

## Connected Devices



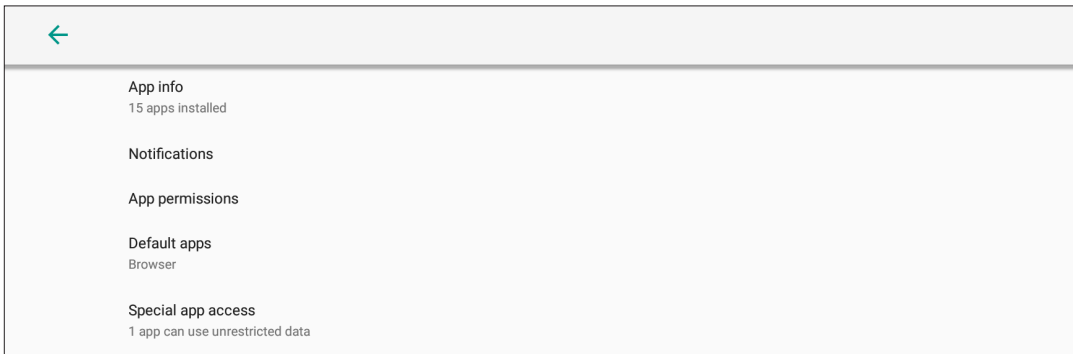

Enable/disable device connection, review connected devices, and search and connect to other devices.

# Apps & Notifications

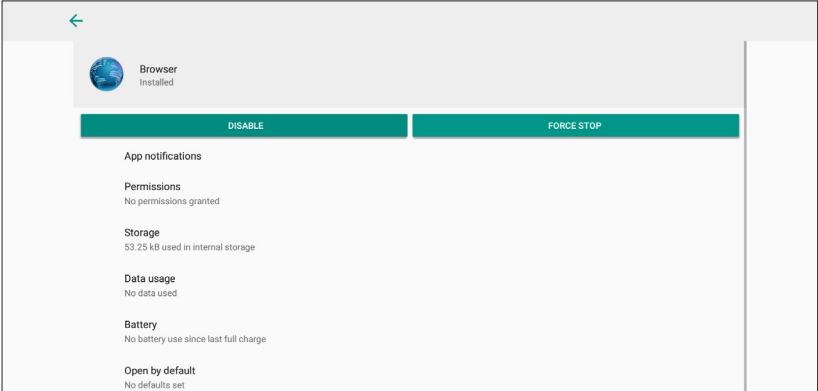

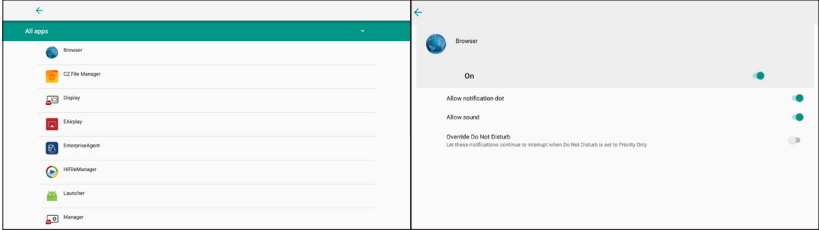
| Sub-menu  | Description  |
|---|--|
| <p style="text-align: center;"><b>App Info.</b></p> | <p>Select <b>App Info</b> to view installed applications and their detailed information.</p>  <p>You can also disable the app, review notifications and permissions, and adjust further settings.</p>  |

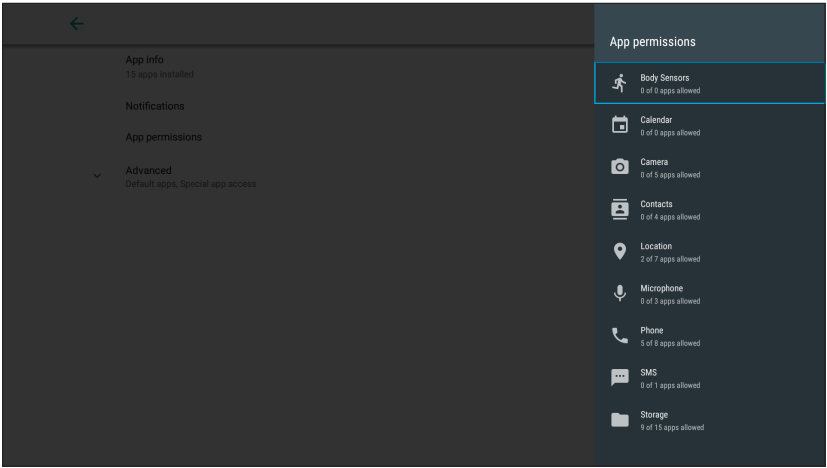
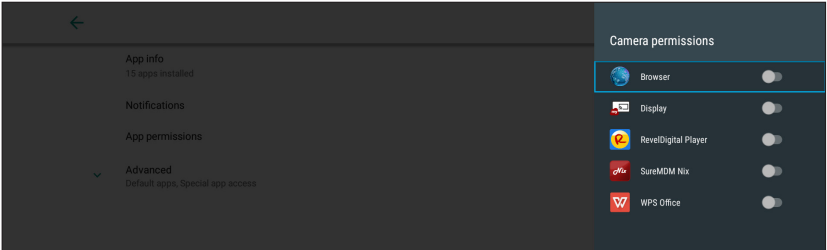
| Sub-menu  | Description   |
|---|---|
| <p style="text-align: center;"><b>Notifications</b></p>   |  <p>Under <b>Notifications</b>, you can adjust each applications notification settings.</p>  <p>You can also allow/disallow notification dots and notifications on the lock screen.</p>  |
| <p style="text-align: center;"><b>App Permissions</b></p> | <p>Select <b>App Permissions</b> to manage various application permissions.</p>     |

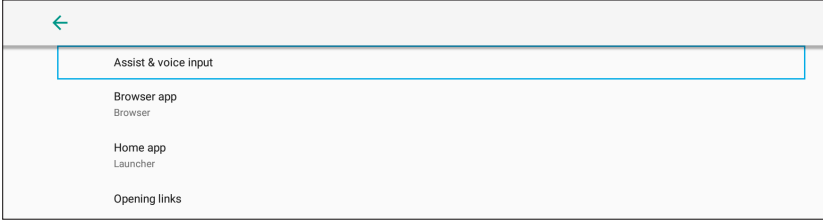
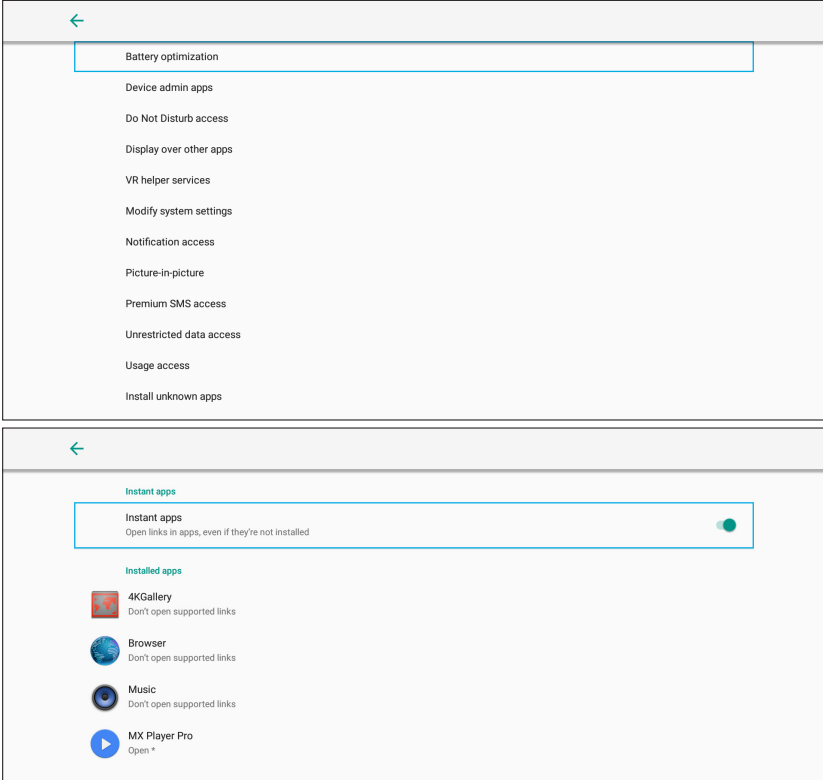
| Sub-menu   | Description   |
|--|---|
| <p style="text-align: center;"><b>Default Apps</b></p>       | <p>Select your default applications.</p>  <p>The screenshot shows a settings page with a back arrow at the top left. The following options are listed: 'Assist &amp; voice input' (highlighted), 'Browser app' (with subtext 'Browser'), 'Home app' (with subtext 'Launcher'), and 'Opening links'.</p>   |
| <p style="text-align: center;"><b>Special App Access</b></p> | <p>Manage additional application settings.</p>  <p>The top screenshot shows a settings page with a back arrow at the top left. The following options are listed: 'Battery optimization' (highlighted), 'Device admin apps', 'Do Not Disturb access', 'Display over other apps', 'VR helper services', 'Modify system settings', 'Notification access', 'Picture-in-picture', 'Premium SMS access', 'Unrestricted data access', 'Usage access', and 'Install unknown apps'.</p> <p>The bottom screenshot shows a settings page with a back arrow at the top left. It features a section for 'Instant apps' with a toggle switch turned on. Below this is a section for 'Installed apps' with the following entries: '4KGallery' (Don't open supported links), 'Browser' (Don't open supported links), 'Music' (Don't open supported links), and 'MX Player Pro' (Open *).</p> |

# Display

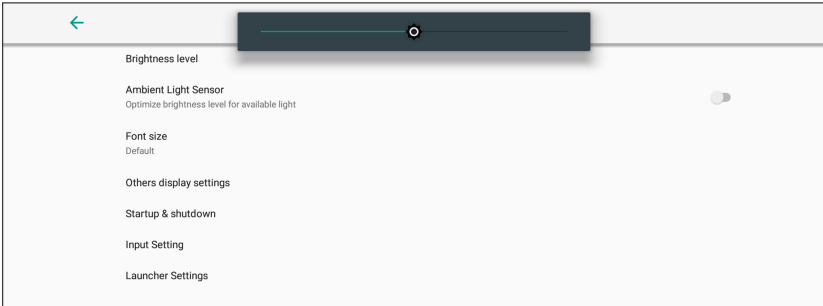
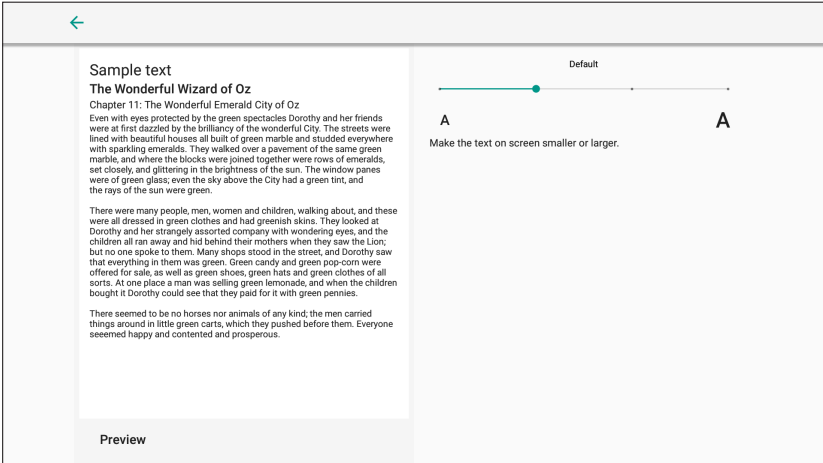

| Sub-menu                              | Description  |
|---------------------------------------|--|
| <p><b>Brightness Level</b></p>        | <p>Adjust the brightness level by eight (8) levels.</p>   |
| <p><b>Ambient Light Sensor</b></p>    | <p>Detects ambient light and adjusts brightness levels automatically.</p>  |
| <p><b>Font Size</b></p>               | <p>Preview and adjust the font size on the display.</p>  |
| <p><b>Others Display Settings</b></p> | <p>Adjust the Resolution, DPI, wallpaper and other display settings.</p>   |





| Sub-menu                        | Description   |
|---------------------------------|---|
| <p><b>Launcher Settings</b></p> | <div data-bbox="592 185 1422 383" data-label="Image"> </div> <p><u>ViewSonic Logo</u><br/>Display or hide the ViewSonic logo on the Home Screen.</p> <p><u>Date &amp; Time</u><br/>Display or hide the date and time on the Home Screen.</p> <p><u>Theme</u><br/>Choose from seven (7) included themes for the Home Screen.</p> <div data-bbox="592 719 1422 1084" data-label="Image"> </div> |

## Sound

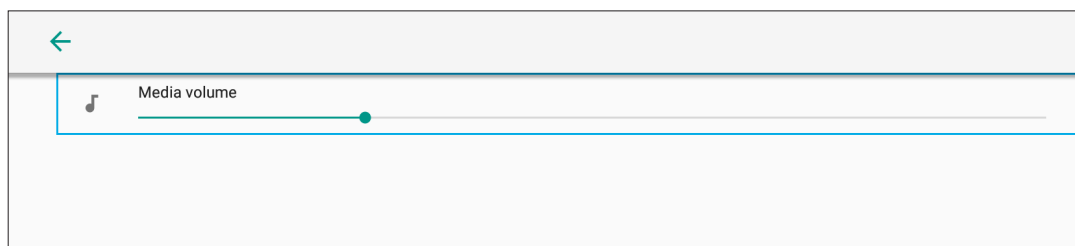

| Sub-menu     | Description                             |
|--------------|---|
| Media Volume | Adjust the volume level of the display. |

## Storage

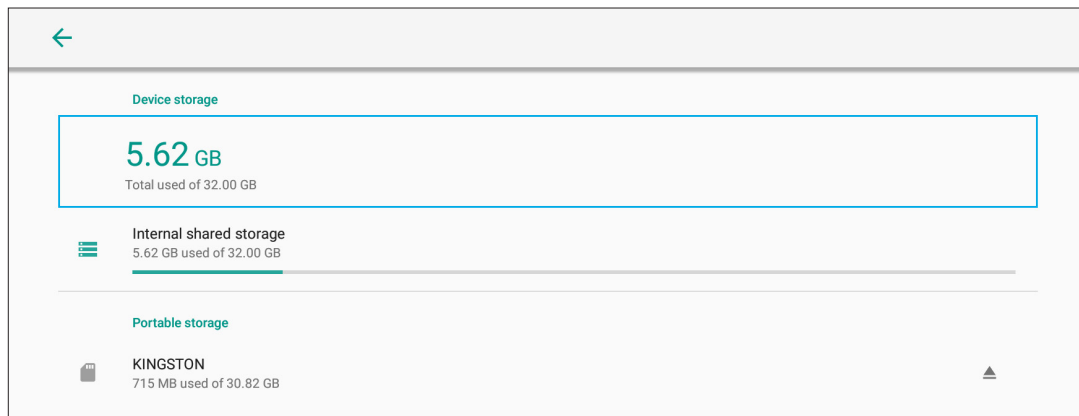

| Sub-menu                | Description                      |
|-------------------------|----------------------------------|
| Device Storage          | Total internal storage used.     |
| Internal Shared Storage | Internal storage allocation.     |
| Portable Storage        | External storage device details. |

# System

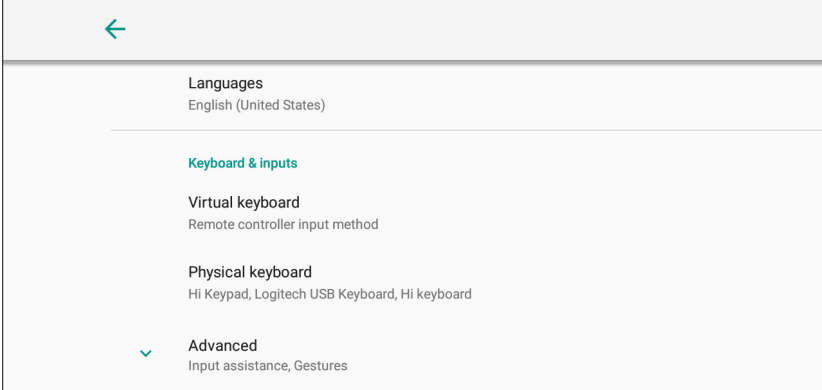

| Sub-menu                            | Description   |
|-------------------------------------|---|
| <p><b>Languages &amp; Input</b></p> |  <p><u>Languages</u><br/>Language selection.</p> <p><u>Virtual Keyboard</u><br/>Select your input method.</p> <p><u>Physical Keyboard</u><br/>Bluetooth and physical keyboard input settings.</p> <p><u>Advanced</u><br/>Adjust Input Assistance, Gestures, Pointer Speed, and Text-to-Speech output.</p> |

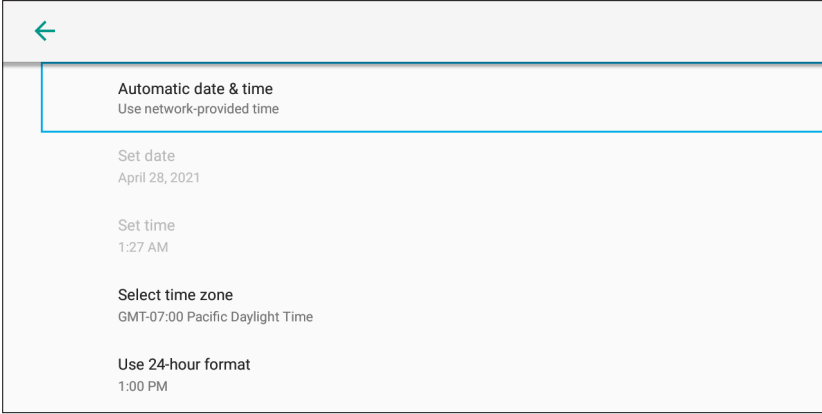
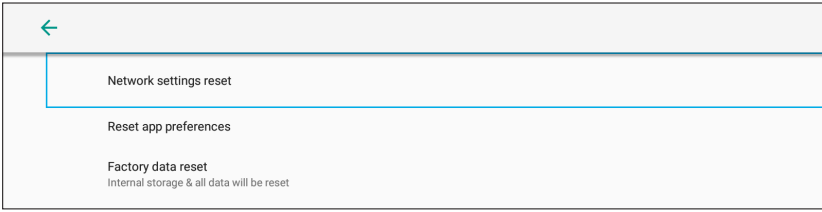
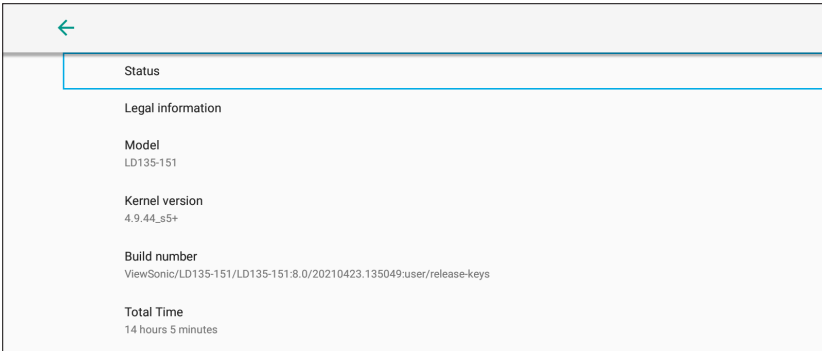
| Sub-menu  | Description   |
|---|---|
| <p style="text-align: center;"><b>Date &amp; Time</b></p> |  <p><u>Automatic Date &amp; Time</u><br/>Enable or disable automatic time adjustment.</p> <p><u>Select Time Zone</u><br/>Choose your appropriate time zone.</p> <p><u>Use 24-hour Format</u><br/>Enable or disable 24-hour time format.</p> |
| <p style="text-align: center;"><b>Reset</b></p>           |  <p><u>Network Settings Reset</u><br/>Reset current network settings.</p> <p><u>Reset App Preferences</u><br/>Reset current app preferences.</p> <p><u>Factory Data Reset</u><br/>Restore the display to default factory settings.</p>     |
| <p style="text-align: center;"><b>About Device</b></p>    | <p>View information about the display.</p>    |



# Upgrade

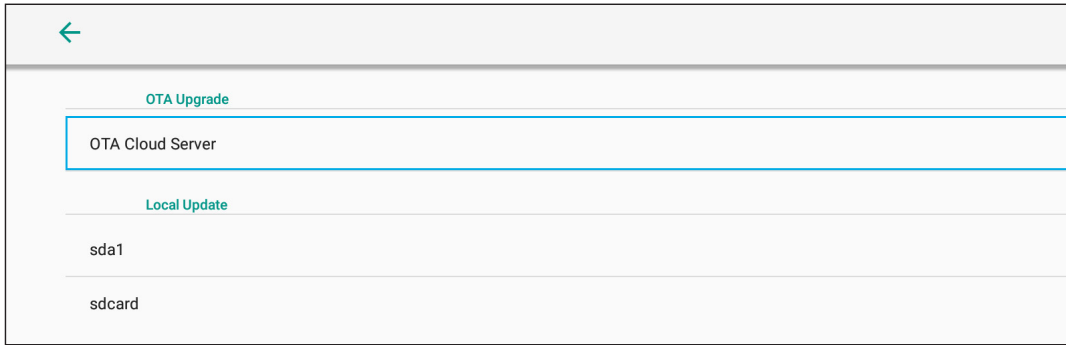

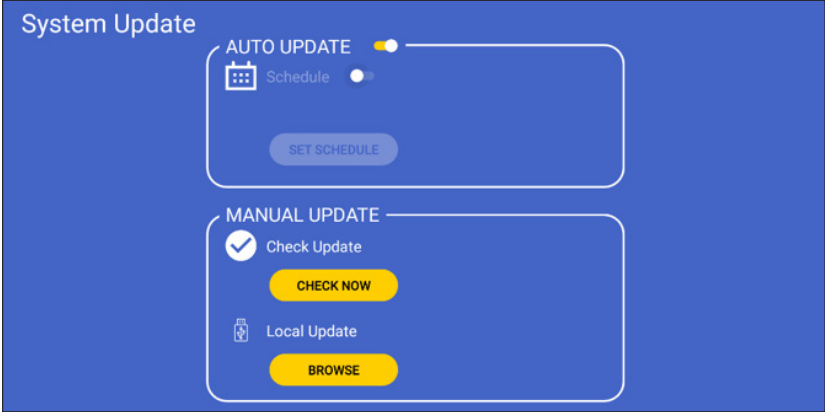
| Sub-menu                  | Description  |
|---------------------------|--|
| <p><b>OTA Upgrade</b></p> |  <p><u>Auto Update</u><br/>Automatically apply updates as they become available or schedule the default update date and choose “Hibernate” as the Standby Mode, and the system will automatically update the schedule after shutdown.</p> <p><u>Manual Update</u><br/><b>Check Update:</b> The system will check for the latest FW automatically. If a new FW version is found, confirm the new FW is needed and then manually run the update.<br/><b>Local Update:</b> Plug in a USB drive with the FW update in .zip format and run the .zip file to update the FW.</p> |

## On-Screen Display (OSD) Menu

Use the On-Screen Display (OSD) Menu to adjust settings.

**NOTE:** The OSD Menu is only available when there is an active input source, e.g. HDMI.

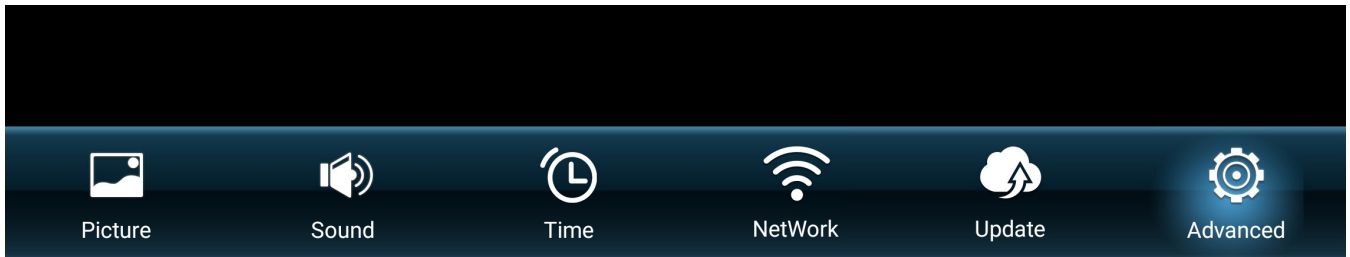

To open and operate the OSD Menu:

1. Press the **MENU** button on the remote control.
2. Press **▼/▲/◀/▶** on the remote control to select menu items or adjust values.
3. Press **OK** to confirm your selection.
4. Press the **RETURN** button to go back to the previous menu level.
5. Press the **MENU** button to exit the OSD Menu.

## On-Screen Display (OSD) Menu Tree

| Main Menu     | Sub-menu     | Menu Option     |               |
|---------------|--------------|-----------------|---------------|
| Picture       | Picture Mode | Mode            | Standard      |
|               |              |                 | Vivid         |
|               |              |                 | Soft          |
|               |              |                 | User          |
|               |              | Brightness      | (-/+ , 0~100) |
|               | Advanced     | Color Temp      | Standard      |
|               |              |                 | Cool          |
|               |              |                 | Warm          |
|               |              | Noise Reduction | Off           |
|               |              |                 | Low           |
|               |              |                 | Middle        |
|               |              |                 | High          |
|               |              | PC Mode         | PC            |
|               |              |                 | Video         |
| Auto          |              |                 |               |
| Picture Reset |              |                 |               |
| Sound         | Sound Mode   | Sound Mode      | Standard      |
|               |              |                 | News          |
|               |              |                 | Music         |
|               |              |                 | Movie         |
|               |              |                 | Sports        |
|               |              |                 | User          |
|               |              | EQ_120Hz        | (-/+ , 0~100) |
|               |              | EQ_500Hz        | (-/+ , 0~100) |
|               |              | EQ_1.5KHz       | (-/+ , 0~100) |
|               |              | EQ_5KHz         | (-/+ , 0~100) |
|               |              | EQ_10KHz        | (-/+ , 0~100) |
| Advanced      | Balance      | (-/+ , -50~50)  |               |
|               | Audio Reset  |                 |               |

| Main Menu      | Sub-menu   | Menu Option      |  |                  |
|----------------|--|------------------|--|------------------|
| Time           | Time Setup   | Time Setting     | Date Picker                            |                  |
|                |  | Shutdown Time    | Repeat:<br>Off/Once/Every day/ Workday |                  |
|                |  |                  | Time                                   |                  |
|                |  | Power ON Time    | Repeat:<br>Off/Once/Every day/ Workday |                  |
|                |  |                  | Time                                   |                  |
|                |  |                  | Source                                 | HDMI 1<br>HDMI 2 |
|                |  | Sleep Timer      | Off/1/10/20/30/60/90/120/ 180/240 min  |                  |
|                |  | Power Saving     | Off/1/3/5/10 min                       |                  |
|                |  | Time Sync        | Network Time                           |                  |
| Off            |  |                  |  |                  |
| Time Zone      | Shanghai/Calcutta/Harare/Karachi/<br>Brazzaville/Beirut/Jerusalem/Tehran/<br>Baghdad/Ulaanbaatar/Damascus/<br>Sydney/Paris/Rome/London/Dubai/<br>Tokyo/US-PT |                  |  |                  |
| NetWork        | Ethernet Setting   | Ethernet Switch  | Off                                    |                  |
|                |  |                  | On                                     |                  |
|                |  | Connection Mode  | DHCP IP                                |                  |
|                | Static IP  |                  |  |                  |
|                | Network Status   |                  |  |                  |
|                | WiFi Setting   | WiFi Switch      | Off                                    |                  |
|                |  |                  | On                                     |                  |
| WiFi List      |  | Scan WiFi List   |  |                  |
|                |  | Add WiFi network |  |                  |
| Network Status |  |                  |  |                  |
| Update         | Local Update   | SD Card          |  |                  |

| Main Menu        | Sub-menu     | Menu Option     |          |  |
|------------------|--------------|-----------------|----------|--|
| <b>Advanced</b>  | Language     | Menu Language   | English  |  |
|                  |              |                 | Français |  |
|                  |              |                 | Español  |  |
|                  |              |                 | Deutsch  |  |
|                  |              |                 | Русский  |  |
|                  |              |                 | Dutch    |  |
|                  |              |                 | 繁體中文     |  |
|                  |              |                 | 简体中文     |  |
|                  |              |                 | Turkish  |  |
|                  | Arabic       |                 |          |  |
|                  | Restore      | Restore Setting |          |  |
|                  |              | Restore Default |          |  |
|                  | About System | CPU             |          |  |
|                  |              | GPU             |          |  |
|                  |              | Memory          |          |  |
| Device Space     |              |                 |          |  |
| OS Version       |              |                 |          |  |
| Software Version |              |                 |          |  |

## Menu Options

### Picture

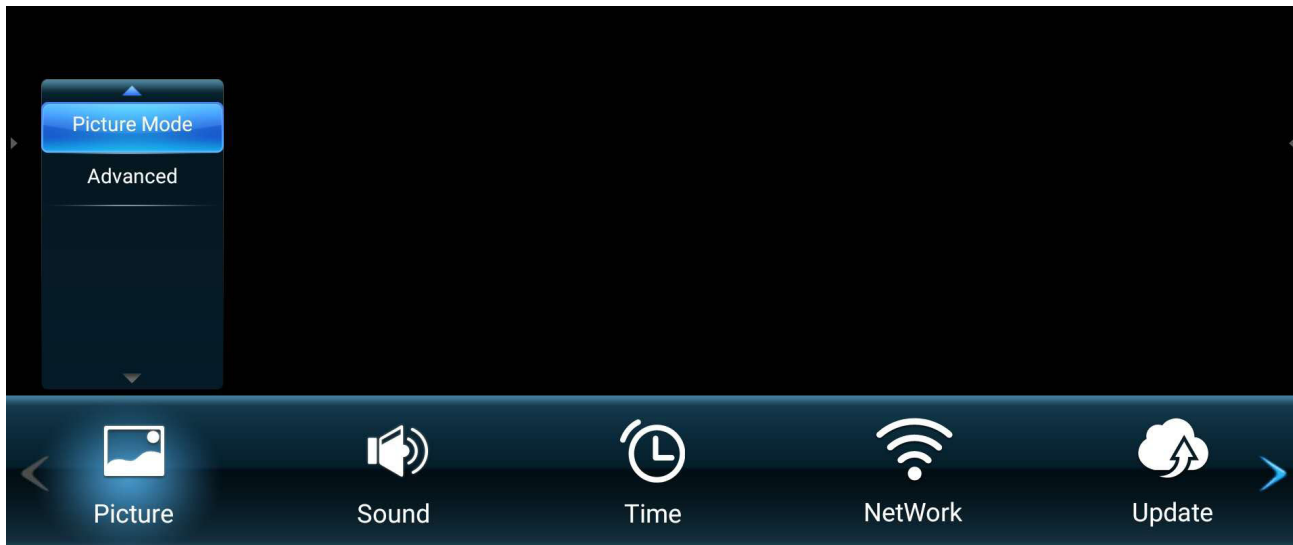

1. Press **MENU** on the remote control to display the OSD Menu.
2. Then press **OK** or use **▼/▲/◀/▶** on the remote control to select the **Picture** menu.
3. Press **▼/▲** to select the menu option. Then press **OK** to display its sub-menu, or press **◀/▶** to adjust/select the setting.

**NOTE:** Some sub-menu options may have another sub-menu layer.

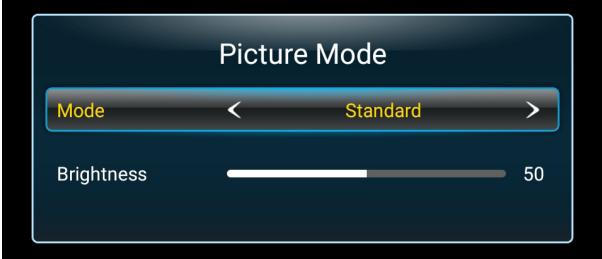
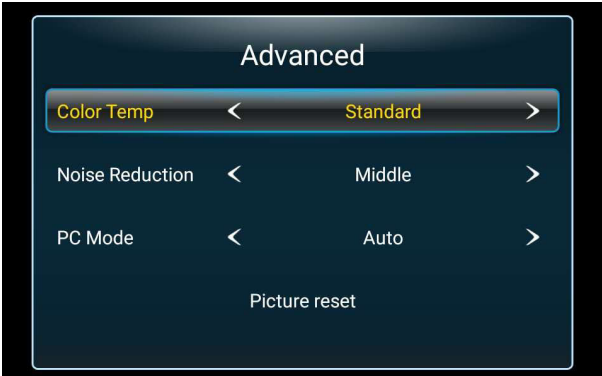
| Menu Option         | Description  |
|---------------------|--|
| <b>Picture Mode</b> |  <p><u>Standard</u><br/>For normal indoor ambient light intensity.</p> <p><u>Vivid</u><br/>Higher brightness level. For bright, indoor areas.</p> <p><u>Soft</u><br/>For dark environments. Lower brightness level.</p> <p><u>User</u><br/>Custom user setting.</p> <p><u>Brightness</u><br/>Adjust the black levels of the screen image.</p>  |
| <b>Advanced</b>     |  <p><u>Color Temp</u></p> <ul style="list-style-type: none"> <li>• Standard: Default standard.</li> <li>• Cool: Set the color temperature to 7500K.</li> <li>• Warm: Set the color temperature to 5000K.</li> </ul> <p><u>Noise Reduction</u><br/>Reduce image noise and distortion. Not available for HDMI input.</p> <p><u>PC Mode</u></p> <ul style="list-style-type: none"> <li>• Auto: Automatically detect input source.</li> <li>• PC: Set the input source to PC.</li> <li>• Video: Set the input source to Video.</li> </ul> <p><u>Picture Reset</u><br/>Restore the settings to default.</p> |



## Sound

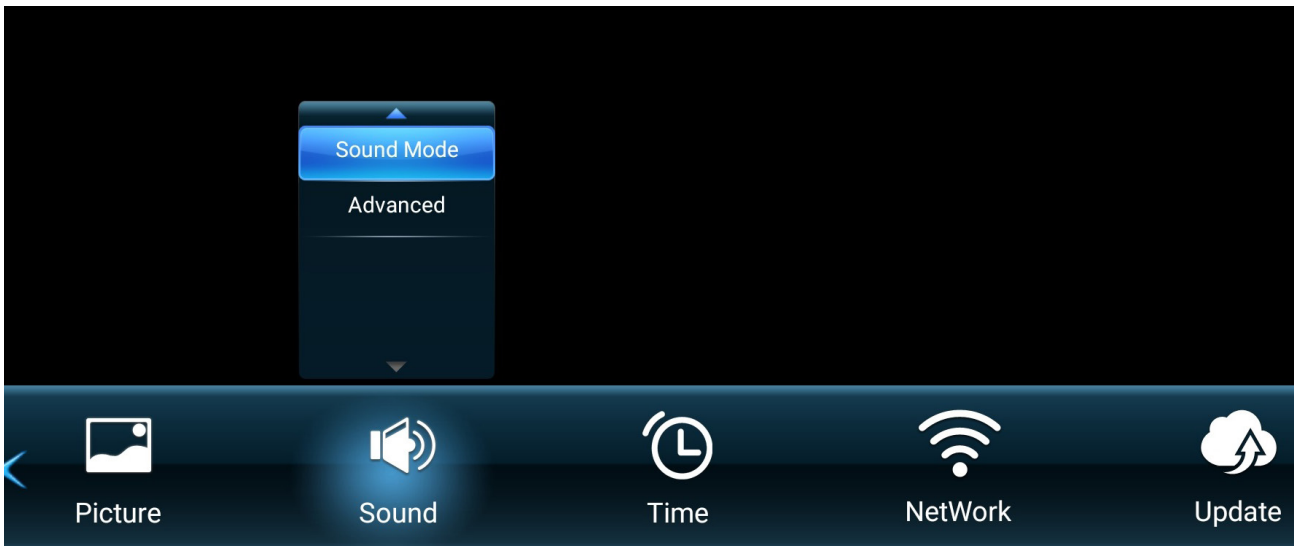

1. Press **MENU** on the remote control to display the OSD Menu.
2. Then press **OK** or use **▼/▲/◀/▶** on the remote control to select the **Sound** menu.
3. Press **▼/▲** to select the menu option. Then press **OK** to display its sub-menu, or press **◀/▶** to adjust/select the setting.

**NOTE:** Some sub-menu options may have another sub-menu layer.

| Menu Option       | Description   |
|-------------------|---|
| <b>Sound Mode</b> | <div data-bbox="644 188 1248 705" data-label="Image"> <p>The screenshot shows the 'Sound Mode' menu with a title bar. Below the title bar is a slider for 'Sound Mode' set to 'Standard'. Below that are five EQ frequency sliders, each set to 50: EQ_120Hz, EQ_500HZ, EQ_1.5KHZ, EQ_5KHZ, and EQ_10KHZ.</p> </div> <p><u>Standard</u><br/>Balanced sound quality and effects. Ensures a natural sound presentation.</p> <p><u>News</u><br/>Reduce the bass and treble, improve voice clarity.</p> <p><u>Music</u><br/>Vibrant treble and stronger bass.</p> <p><u>Movie</u><br/>Enhance the sense of space.</p> <p><u>Sports</u><br/>Enhanced focus on dialogue and speech.</p> <p><u>User</u><br/>Customize the audio equalizer.</p> |
| <b>Advanced</b>   | <div data-bbox="644 1344 1248 1630" data-label="Image"> <p>The screenshot shows the 'Advanced' menu with a title bar. Below the title bar is a slider for 'Balance' set to 0. Below the slider is the text 'Audio reset'.</p> </div> <p><u>Balance</u><br/>Adjust the audio balance from -50~50.</p> <p><u>Audio Reset</u><br/>Restore the settings to default.</p>   |

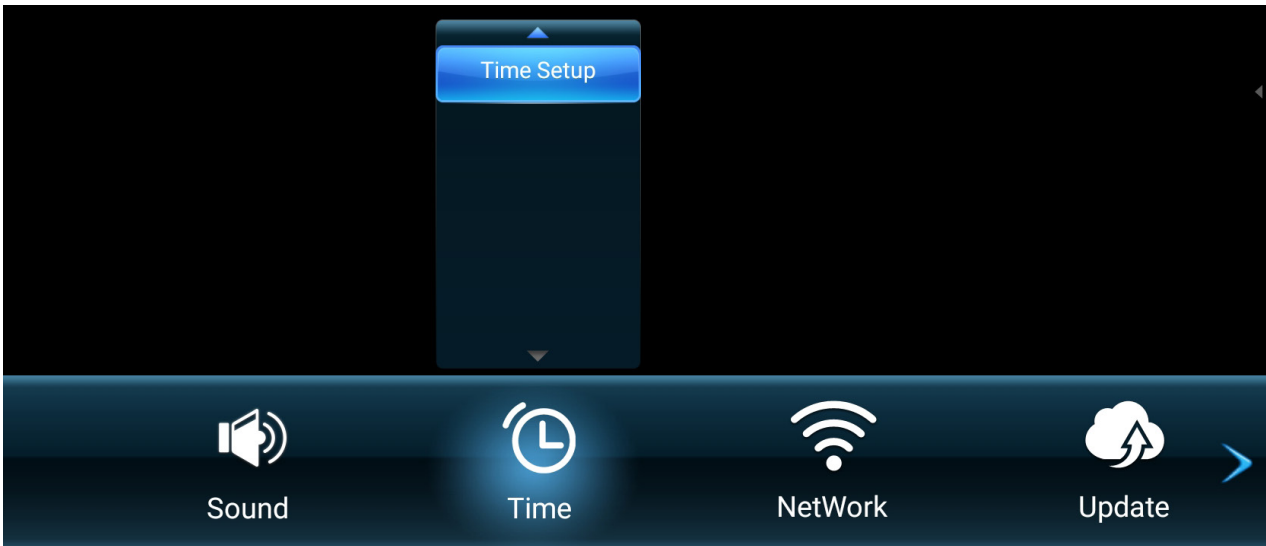

# Time

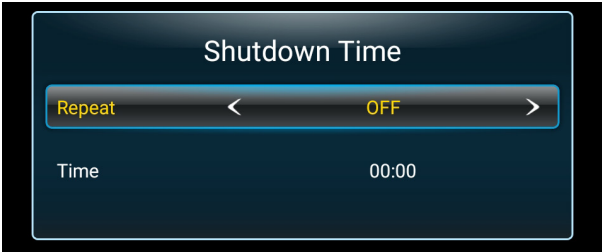

1. Press **MENU** on the remote control to display the OSD Menu.
2. Then press **OK** or use **▼/▲/◀/▶** on the remote control to select the **Time** menu.
3. Press **▼/▲** to select the menu option. Then press **OK** to display its sub-menu, or press **◀/▶** to adjust/select the setting.

**NOTE:** Some sub-menu options may have another sub-menu layer.

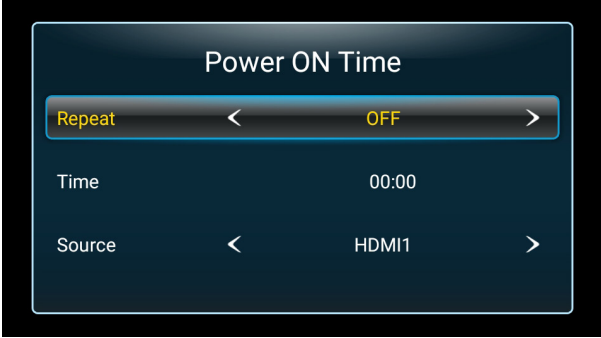
| Menu Option          | Description   |
|----------------------|---|
| <b>Time Setting</b>  |  <p>Set the time and date.</p>                  |
| <b>Shutdown Time</b> |  <p>Schedule a shutdown time and frequency.</p> |

| Menu Option          | Description   |
|----------------------|---|
| <b>Power ON Time</b> |  <p>Schedule a power on time and frequency and tie to the input source.</p>                             |
| <b>Sleep Timer</b>   |  <p>Set a specific time for the display to enter stand-by mode.</p>                                    |
| <b>Power Saving</b>  |  <p>Set a specific time for the display to enter stand-by mode after no input source is detected.</p> |

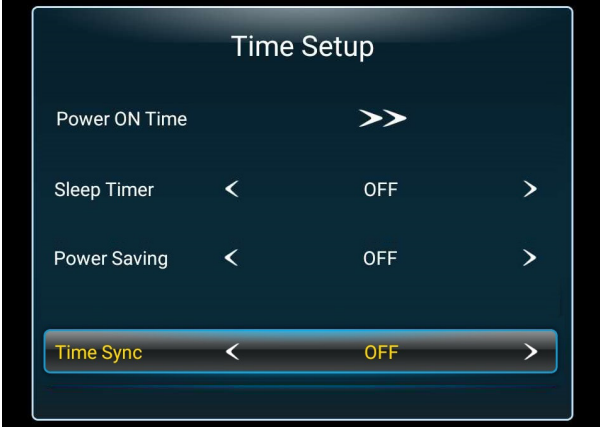
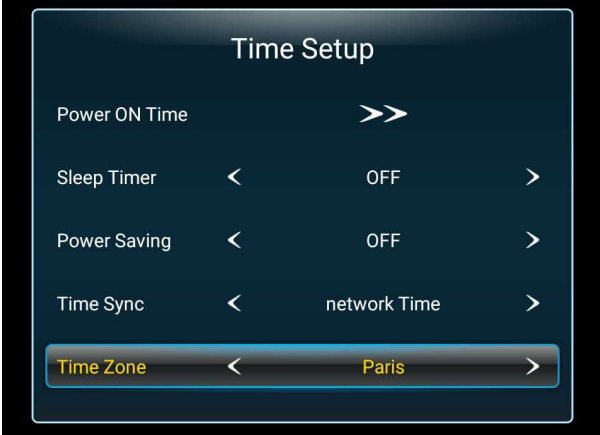
| Menu Option      | Description   |
|------------------|---|
| <b>Time Sync</b> |  <p>The screenshot shows a 'Time Setup' menu with four options: 'Power ON Time' with a right arrow, 'Sleep Timer' with left and right arrows and 'OFF' in the center, 'Power Saving' with left and right arrows and 'OFF' in the center, and 'Time Sync' with left and right arrows and 'OFF' in the center. The 'Time Sync' option is highlighted with a blue glow.</p> <p>Toggle network synchronization On or Off.</p>                 |
| <b>Time Zone</b> |  <p>The screenshot shows a 'Time Setup' menu with four options: 'Power ON Time' with a right arrow, 'Sleep Timer' with left and right arrows and 'OFF' in the center, 'Power Saving' with left and right arrows and 'OFF' in the center, and 'Time Sync' with left and right arrows and 'network Time' in the center. The 'Time Zone' option is highlighted with a blue glow.</p> <p>Select the appropriate time zone for your area.</p> |

# NetWork

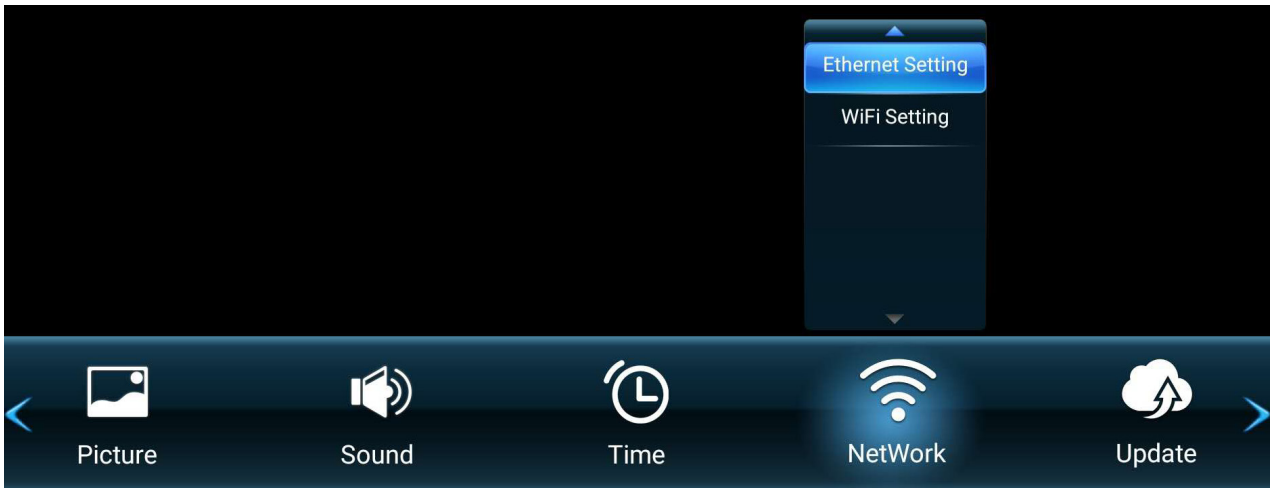

1. Press **MENU** on the remote control to display the OSD Menu.
2. Then press **OK** or use **▼/▲/◀/▶** on the remote control to select the **NetWork** menu.
3. Press **▼/▲** to select the menu option. Then press **OK** to display its sub-menu, or press **◀/▶** to adjust/select the setting.

**NOTE:** Some sub-menu options may have another sub-menu layer.

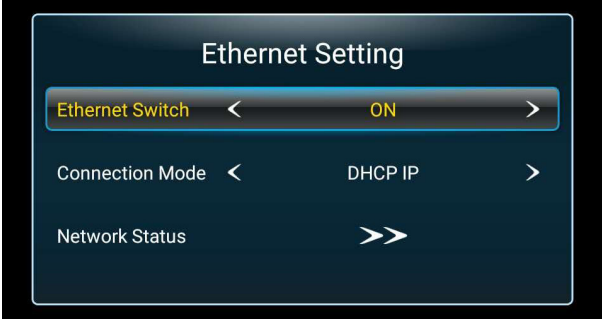
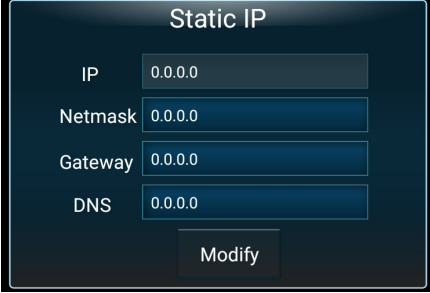
| Menu Option                    | Description  |
|--------------------------------|--|
| <p><b>Ethernet Setting</b></p> | <div style="text-align: center;">  </div> <p><u>Ethernet Switch</u><br/>Toggle the wired network connection On or Off.</p> <p><u>Connection Mode</u><br/>Select the network connection method, DHCP IP or Static IP.</p> <div style="text-align: center;">  </div> <p><b>NOTE:</b> If Manual IP is selected, you need to configure the IP, Netmask, Gateway, and DNS.</p> <p><u>Network Status</u><br/>View the network connection status.</p> |

| Menu Option         | Description   |
|---------------------|---|
| <b>WiFi Setting</b> | <div data-bbox="644 188 1248 504" data-label="Image"> </div> <p data-bbox="485 517 651 551"><u>WiFi Switch</u></p> <p data-bbox="485 557 1011 591">Toggle the WiFi connection On or Off.</p> <p data-bbox="485 613 606 647"><u>WiFi List</u></p> <p data-bbox="485 654 1214 687">View the available Wi-Fi networks, or add manually.</p> <p data-bbox="485 710 703 743"><u>Network Status</u></p> <p data-bbox="485 750 1002 784">View the network connection status.</p> <div data-bbox="697 801 1193 1162" data-label="Image"> </div> |



## Update

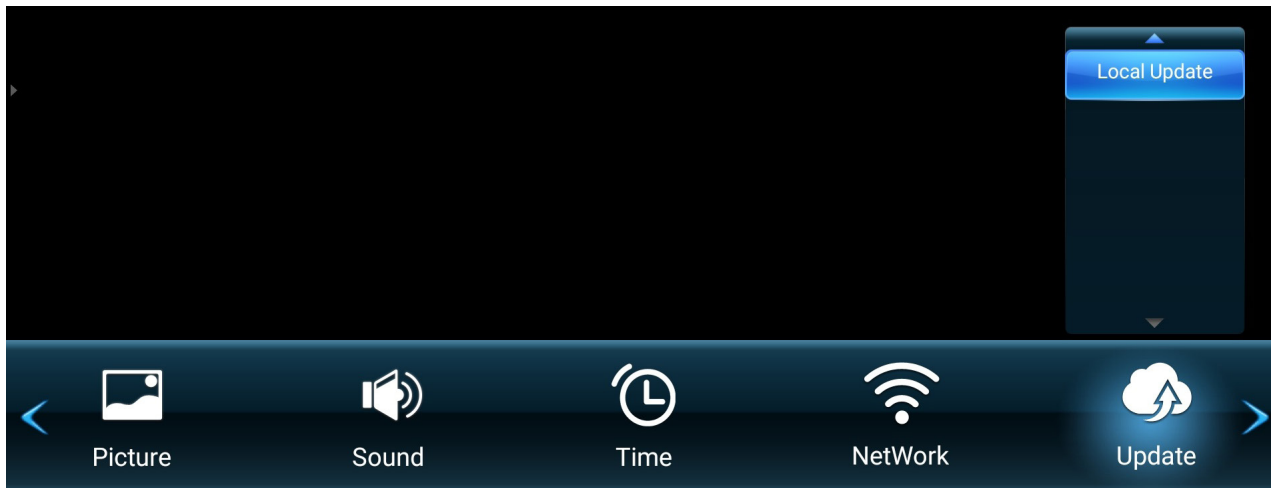

1. Press **MENU** on the remote control to display the OSD Menu.
2. Then press **OK** or use **▼/▲/◀/▶** on the remote control to select the **Update** menu.
3. Press **▼/▲** to select the menu option. Then press **OK** to display its sub-menu.

| Menu Option         | Description   |
|---------------------|---|
| <b>Local Update</b> | Update the display by using the update file on an SD Card or USB flash drive. |

## Advanced

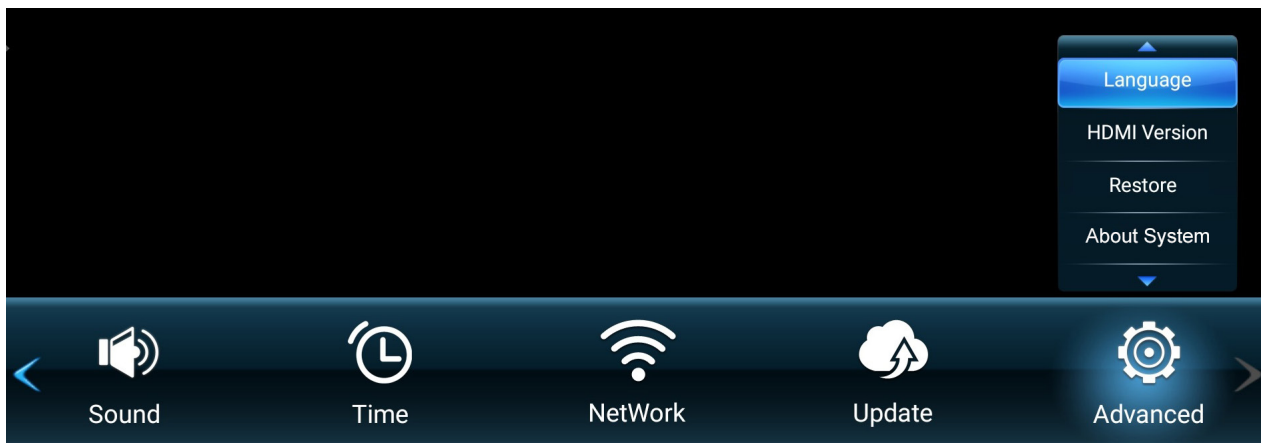

1. Press **MENU** on the remote control to display the OSD Menu.
2. Then press **OK** or use **▼/▲/◀/▶** on the remote control to select the **Advanced** menu.
3. Press **▼/▲** to select the menu option. Then press **OK** to display its sub-menu, or press **◀/▶** to adjust/select the setting.

**NOTE:** Some sub-menu options may have another sub-menu layer.

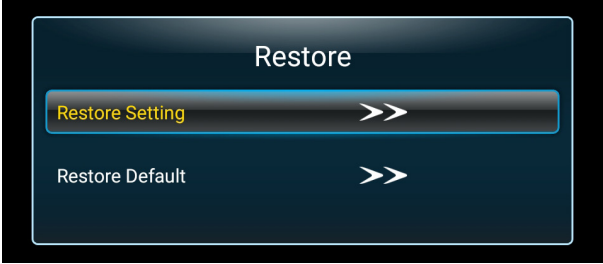
| Menu Option     | Description   |
|-----------------|---|
| <b>Language</b> |  <p><u>Menu Language</u><br/>Set the OSD Menu language.</p>   |
| <b>Restore</b>  |  <p><u>Restore Setting</u><br/>Reset the OSD settings.</p> <p><u>Restore Default</u><br/>Restore to factory default settings.</p> <p><b>NOTE:</b> All settings will be reset to default, including any additional APPs installed by the user.</p> |

| Menu Option         | Description  |
|---------------------|--|
| <b>About System</b> | <div data-bbox="644 188 1248 703" data-label="Image"> <p>The screenshot shows a dark-themed 'About System' window with the following details:</p> <ul style="list-style-type: none"> <li>CPU: 4 Core</li> <li>GPU: 2 Core</li> <li>Memory: 3.74 G</li> <li>Device Space: 24.77 G</li> <li>OS Version: 8.0.0</li> <li>Software Version: VS_V811_LD135-151_20200527</li> </ul> </div> <p data-bbox="485 719 1382 831">View system information such as: CPU core count, GPU core count, Memory used, Storage Space remaining, OS version, and Software version.</p> |

# > Embedded Applications

## ViewBoard Cast

Working with ViewBoard® Cast software, the vCastReceiver app, will allow the LED display to receive vCastSender screen sharing (Windows/Mac/Chrome) and mobile (iOS/Android) users' screens, photos, videos, annotations, and camera(s).

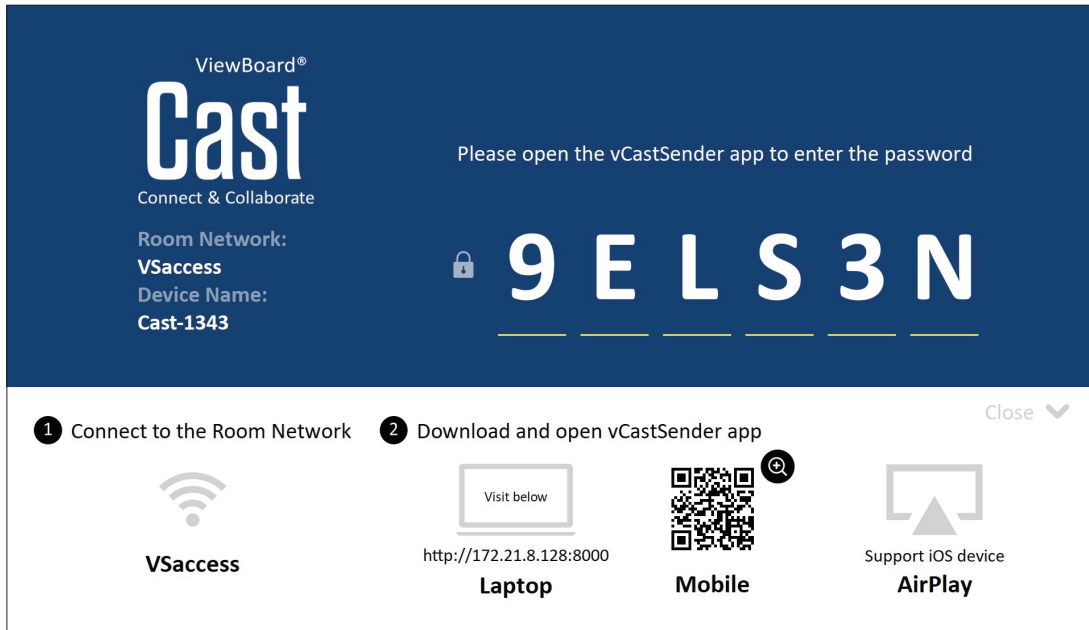

### Network Information

- ViewBoard® Cast software, laptops, and mobile devices can be connected to the same subnet and across the subnet as long as it can communicate between the two.
- Connected devices will show up under “Device List” on the same subnet connection.
- If the device does not show up under “Device List”, users will need to key-in the on-screen PIN-code.

ViewBoard Cast is a wireless peer to peer data communication, therefore the following port settings are required:

#### Ports:

- CP: 56789, 25123, 8121, and 8000
- UDP: 48689 and 25123

#### Port and DNS activation:

- Port: 8001
- DNS: h1.ee-share.com

# Cast Sender from Windows-based Devices, Macbook, and Chrome devices.

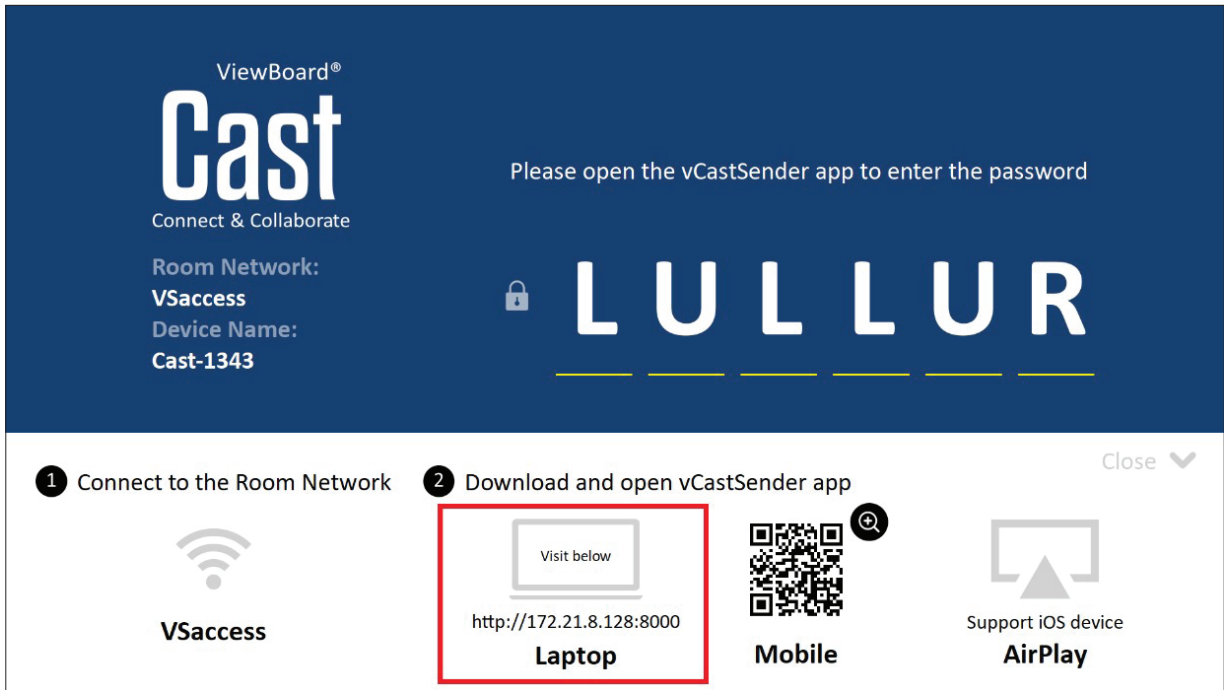

## Mac, Windows, Chrome Devices:

1. Make sure your device is connected to the same network as the display.
2. Open a web browser and enter the address that is shown on the display to download the application.
3. Launch the application and click the connect icon next to the Device Name.

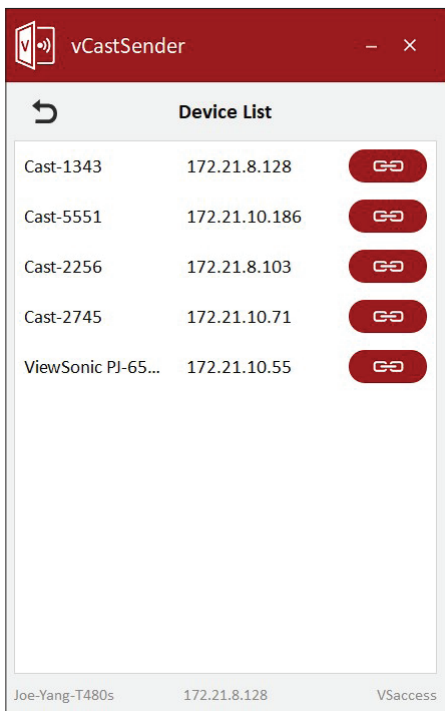

**NOTE:** If the device is not listed, click **Connect with PIN-Code** and input the pin-code displayed on the display.

## Cast Sender from Mobile Devices: iOS-based (iPhone, iPad) and Android OS based phone/tablet.



### Android/iOS:

1. Make sure your device is connected to the same network as the display.
2. Scan the QR Code that is shown on the display to download the client application directly from the server, or download from the Google Play Store or the Apple Store.
3. Launch the application and select the correct Device Name and input the pin to connect. You can also directly input the pin-code displayed on the display to connect.





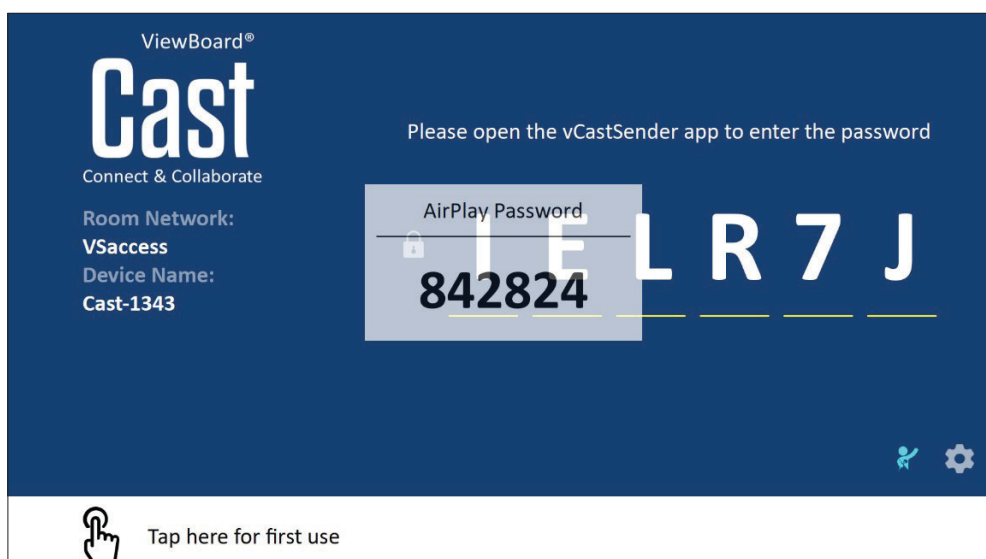

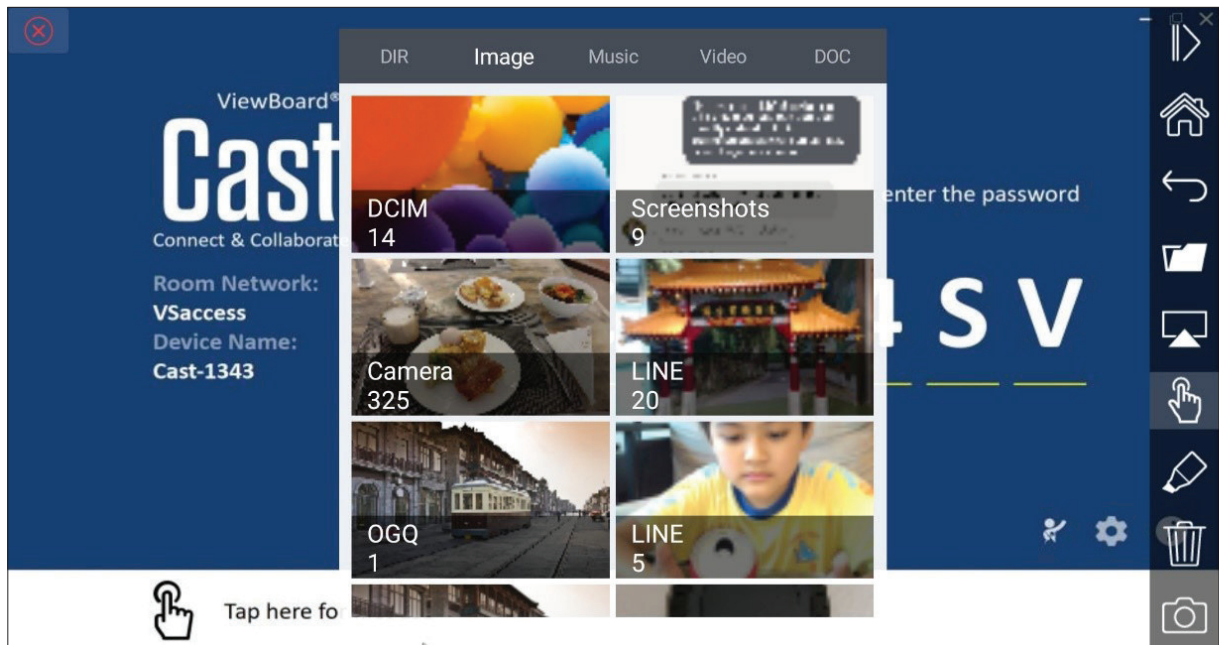

### Apple AirPlay®:

1. Make sure your device is connected to the same network as the display.
2. Directly open AirPlay and select the Device Name to connect.
3. Another "AirPlay Password" will be generated on-screen for the connection.



## Cast Out from a Mobile Device that Supports Annotation



| Item  | Description  |
|---|--|
|  <b>Toggle</b>          | Click to hide or display tool bar                            |
|  <b>Home</b>           | Click to return to the Home interface                        |
|  <b>Return</b>         | Click to return to previous operation interface              |
|  <b>Folder</b>         | Click to view or open the mobile device's internal file      |
|  <b>Screen sharing</b> | Click to share screen<br>(Android 5.0 and above supported)   |
|  <b>Touch</b>          | Click to change to touch mode                                |
|  <b>Pen</b>            | Click to make annotations, and to change color and thickness |
|  <b>Clear</b>          | Click to clear everything on the screen                      |
|  <b>Camera</b>         | Click to use the camera and send the image to the ViewBoard  |

# vSweeper

Remove unnecessary data and unwanted files.

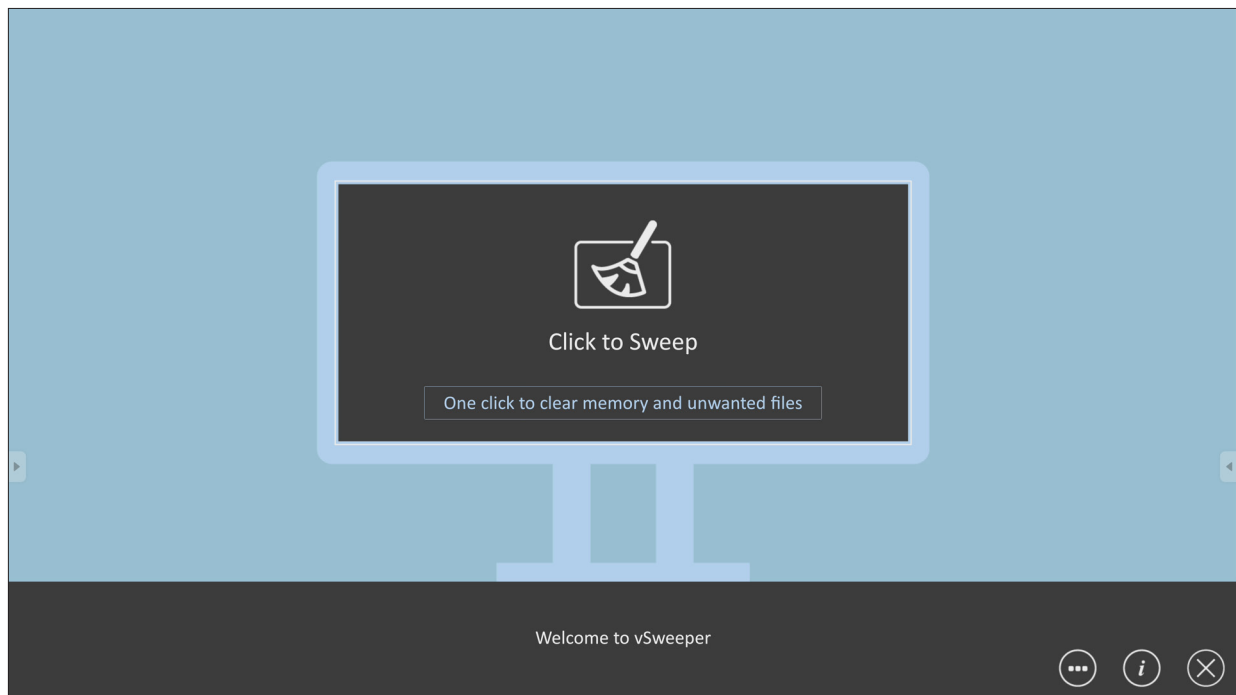

Advanced Settings can also be customized to the user's needs.

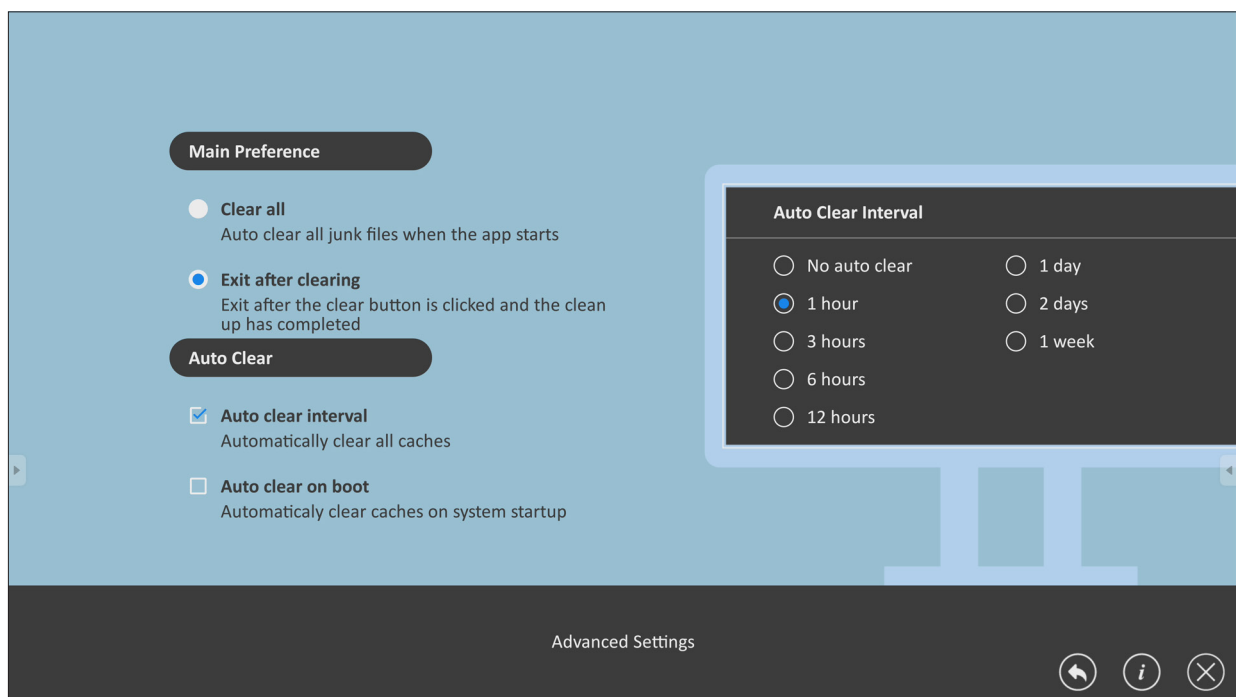



# Browser

Web browser for surfing the Internet.

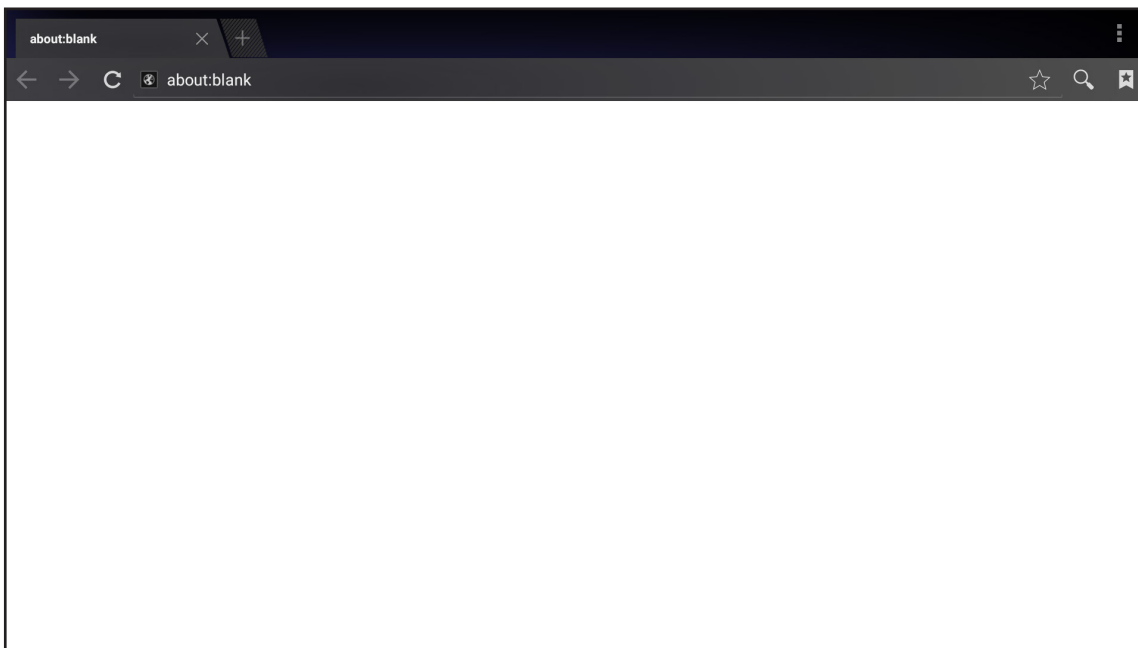

# WPS Office

Create, edit, and view Documents, Memos, Presentations, and Spreadsheets.

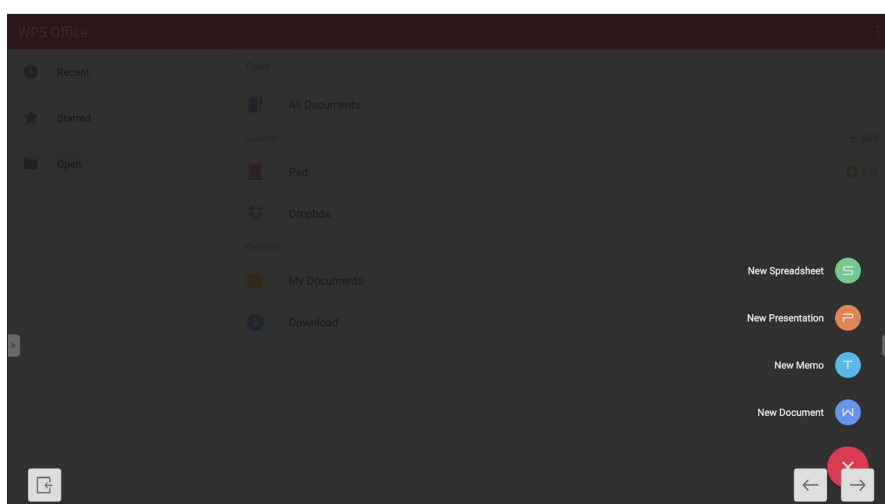
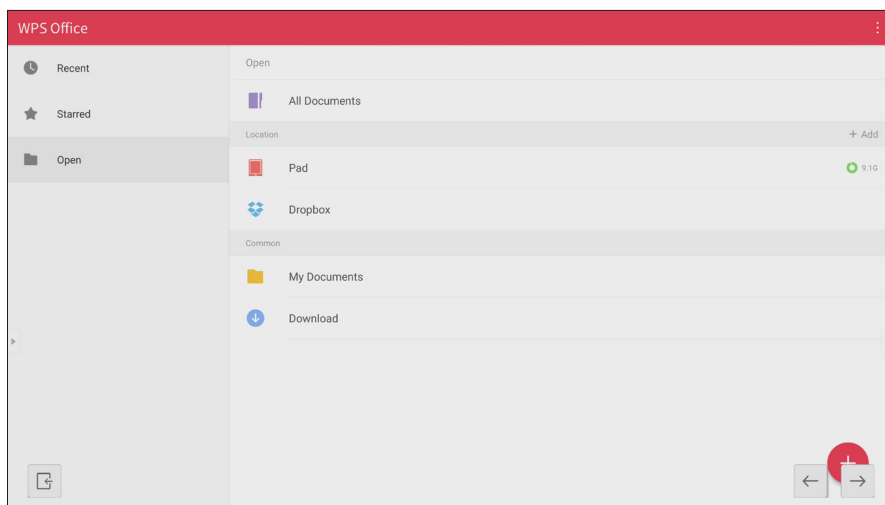

# > Appendix

## Specifications

| Item                            | Category          | Specifications  |
|---------------------------------|-------------------|---|
| Model                           |                   | LD135-151   |
| LED Screen                      | Type              | Direct View LED Display   |
|                                 | Size              | 135"  |
|                                 | Active Size       | 118.11" (H) x 66.44" (V)<br>3,000 mm (H) x 1,687.5 mm(V)  |
|                                 | Pitch Size        | 1.5625 mm   |
|                                 | Resolution        | FHD, 1920 x 1080  |
|                                 | Refresh Frequency | 4440Hz  |
|                                 | Contrast Ratio    | 6000:1 (Typical)  |
|                                 | Brightness        | 100-600 cd/m2 (8 levels of adjustments)   |
|                                 | LED Lifespan      | 100,000 hours   |
| Input Signal                    |                   | 2 x HDMI (1920 x 1080 @ 60Hz, HDCP 1.4)<br>1 x LAN (RJ45)<br>1 x USB Type A (3.0)<br>2 x USB Type A (2.0)                         |
| Output Signal                   |                   | 1 x HDMI (1080p @ 60Hz)<br>1 x Audio Out (3.5 mm)<br>1 x USB Type B (for debug)<br>1 x USB Type A (Power)[5V/1A x 1; 5V/0.5A x 2] |
| Speaker Output                  |                   | 5W x 2 Stereo   |
| RS-232                          |                   | RS-232 Serial Control   |
| Power                           | Voltage           | 100-120V/30A ~ 50/60Hz  |
|                                 |                   | 220-240V/15A ~ 50Hz<br>(vary by country)  |
| Operating Conditions            | Temperature       | 32° F to 104° F (0° C to 40° C)   |
|                                 | Humidity          | 20%~80% non-condensing  |
|                                 | Altitude          | ≤ 6,562 ft (2,000 m)  |
| Storage Conditions              | Temperature       | -4° F to 140° F (-20° C to 60° C)   |
|                                 | Humidity          | 10%~90% non-condensing  |
|                                 | Altitude          | ≤ 6,562 ft (2,000 m)  |
| Physical Dimensions (W x H x D) | w/o Wall Mount    | 3,020.95 x 1,805.95 x 35 mm<br>(118.94" x 71.10" x 1.38")   |
|                                 | w/ Wall Mount     | 3,020.95 x 1,805.95 x 56 mm<br>(118.94" x 71.10" x 2.2")  |
| Weight                          | Physical          | 135 kg (297.62 lb)  |
| Power Consumption               | On                | 2,030W (Normal)<br>2,900W (Max)   |
|                                 | Sleep             | <0.5W   |
|                                 | Off               | <0W   |

**NOTE:** Product specifications are subject to change without notice.

## LED Display Stuck Pixel Definition

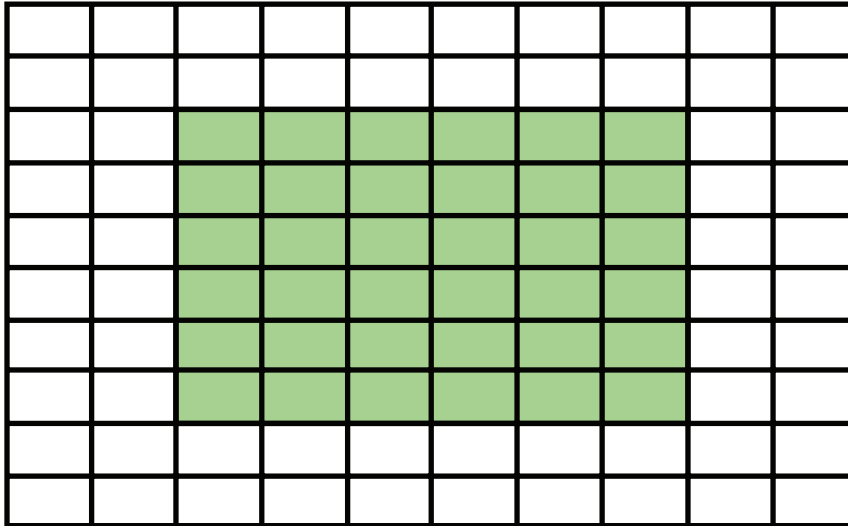

| Item                                | Acceptance Criteria |
|-------------------------------------|---------------------|
| Stuck Pixel<br>(whole display)      | ≤ 60 stuck pixels   |
| Stuck Pixel<br>(as marked in green) | ≤ 15 stuck pixels   |
| Stuck Pixel<br>(Single Module)      | ≤ 6 stuck pixels    |

# Timing Chart

## HDMI (PC)

| Resolution  | Refresh Rate (Hz) |
|-------------|-------------------|
| 640 x 480   | 60, 72, 75        |
| 720 x 400   | 70, 85            |
| 800 x 600   | 56, 60, 72, 75    |
| 832 x 624   | 75                |
| 1024 x 768  | 60, 70, 75        |
| 1152 x 864  | 60, 70, 75        |
| 1152 x 870  | 75                |
| 1280 x 720  | 60                |
| 1280 x 960  | 60                |
| 1280 x 1024 | 60, 75            |
| 1360 x 768  | 85                |
| 1440 x 900  | 60                |
| 1680 x 1050 | 60                |
| 1600 x 1200 | 60, 70, 75        |
| 1920 x 1080 | 60                |
| 1920 x 1200 | 60                |

## HDMI (Video)

| Video | Resolution  | Refresh Rate (Hz)  |
|-------|-------------|--------------------|
| 480i  | 720 x 480   | 60                 |
|       | 1440 x 480  | 60                 |
| 576i  | 720 x 576   | 50                 |
|       | 1440 x 576  | 50                 |
| 480p  | 720 x 480   | 60                 |
| 576p  | 720 x 576   | 50                 |
|       | 1440 x 576  | 50                 |
| 720p  | 1280 x 720  | 60                 |
| 1080i | 1920 x 1080 | 50, 60             |
| 1080p | 1920 x 1080 | 24, 25, 30, 50, 60 |

### NOTE:

- The computer text quality is optimal in HD 1080 mode (1920 x 1080, 60Hz).
- Your computer display screen might appear different depending on the manufacturer and your operating system.
- Consult your computer's instructional manual on how to connect to an external display.
- If a vertical and horizontal frequency-select mode exists, select 60Hz (vertical) and 67.5KHz(horizontal). In some cases, abnormal signals (such as stripes) might appear on the screen when the computer power is turned off (or if the computer is disconnected). If this is the case, press the [INPUT SOURCE] button to enter the video mode and supply an active signal.
- The display timings conform to VESA and CTA standards.
- For 4:3 content, the screen will display them in the center of the screen and maintain a 4:3 aspect ratio.
- The optimal vertical frequency for each mode is 60Hz.

# Supported Media Formats

## Multimedia Codec Formats

| Type  | File Type  | Codec    | Ability  |
|-------|------------|----------|--|
| Photo | PNG        |          | Max Resolution: 8000 × 8000<br>Min Resolution : 4 x 4              |
|       | JPEG/JPG   |          | Max Resolution: 8000 × 8000<br>Min Resolution : 4 x 4 <sup>1</sup> |
| Video | .3gp       | H.263    | Max Resolution: 1920 x 1080 30<br>Audio: AMR_NB                    |
|       |            | MPEG-4   | Max Resolution: 1920 x 1080 30<br>Audio: AMR_NB                    |
|       | .avi       | MPEG-2/4 | Max Resolution: 1920 x 1080 30<br>Audio: MPEG_Audio_Layer3         |
|       |            | MJPEG    | Max Resolution: 1920 x 1080 30<br>Audio: MPEG_Audio_Layer3         |
|       | .flv       | H.264    | Max Resolution: 1920 x 1080 30<br>Audio: AAC 2.0                   |
|       | .mkv       | H.264    | Max Resolution: 1920 x 1080 30<br>Audio: AAC 2.0                   |
|       |            | H.265    | Max Resolution: 1920 x 1080 30<br>Audio: AAC 2.0                   |
|       | .mp4       | H.264    | Max Resolution: 3840 x 2160 30<br>Audio: MPEG_Audio_Layer3         |
|       |            | H.265    | Max Resolution: 3840 x 2160 30<br>Audio: MPEG_Audio_Layer3         |
|       |            | MPEG-4   | Max Resolution: 1920 x 1080 30<br>Audio: MPEG_Audio_Layer3         |
|       | .vob       | MPEG-2   | Max Resolution: 1920 x 1080 30<br>Audio: PCM                       |
|       | .mpg/.mpeg | MPEG-2   | Max Resolution: 1920 x 1080 30<br>Audio: MPEG_Audio_Layer3         |

1 Progressive support 4000 × 4000; baseline support 8000 x 8000.

| Type  | File Type | Codec           | Ability   |
|-------|-----------|-----------------|---|
| Audio | .aac      | GAAC            | Sample Rate: 8K~96KHz<br>Bit Rate: 24K~576Kbps    |
|       | .ape      | Monkey's Audio  | Sample Rate: max 48KHz<br>Bit Rate: max 1411Kbps  |
|       | .flac     | FLAC            | Sample Rate: max 192KHz<br>Bit Rate: max 1411Kbps |
|       | .m4a      | ALAC            | Sample Rate: 8K~96KHz<br>Bit Rate: 24K~576Kbps    |
|       | .mp3      | MPEG1/2 layer 3 | Sample Rate: 8K~48KHz<br>Bit Rate: 32K~320Kbps    |
|       | .ogg      | Vorbis          | Sample Rate: 8K~48KHz<br>Bit Rate: max 256Kbps    |
|       | .wav      | LPCM            | Sample Rate: 8K~192KHz<br>Bit Rate: max 320Kbps   |

## Troubleshooting

| Problem or Issue                                      | Possible Solutions  |
|---|---|
| Remote Control is not working                         | <ol style="list-style-type: none"> <li>1. Check whether something is obstructing the display's remote control receiver.</li> <li>2. Check whether the battery polarities in the remote control are installed correctly.</li> <li>3. Check whether the batteries need to be replaced.</li> </ol> |
| The unit turns off unexpectedly                       | <ol style="list-style-type: none"> <li>1. Check whether Sleep mode is enabled.</li> <li>2. Check if there is a power outage in your area.</li> <li>3. Turn on the display, provide an active signal, and see if the problem is with the signal or external control system.</li> </ol>           |
| The power indicator is off, and there is no response  | <ol style="list-style-type: none"> <li>1. Ensure the power cable is connected and not loose.</li> <li>2. Check that the power outlet is functioning properly and meets the required electrical requirement.</li> </ol>  |
| The display does not recognize the USB storage device | <ol style="list-style-type: none"> <li>1. Ensure the drive is either formatted for FAT32 or NTFS.</li> <li>2. If the USB storage device needs external power, connect its power adapter to an electrical outlet.</li> </ol>   |

### Video Not Working Properly

| Problem or Issue                      | Possible Solutions   |
|---------------------------------------|--|
| No picture/No sound                   | <ol style="list-style-type: none"> <li>1. Check the Power status.</li> <li>2. Check the signal cable.</li> <li>3. Use the remote control to ensure the input source setting is the same as the connected device.</li> </ol>  |
| Picture is unclear or cuts in and out | <ol style="list-style-type: none"> <li>1. Check the signal cable.</li> <li>2. Check if other electronics or different signal types are interrupting the signal.</li> <li>3. An optional active video cable or optional video extender is required for a long distance source.</li> </ol> |



| <b>Problem or Issue</b> | <b>Possible Solutions</b>  |
|-------------------------|--|
| Poor picture            | <ol style="list-style-type: none"> <li>1. Adjust chroma and/or brightness settings in the menu.</li> <li>2. Check the signal cable.</li> <li>3. Use the display's native resolution for the source.</li> </ol> |

### Audio Not Working Properly

| <b>Problem or Issue</b> | <b>Possible Solutions</b>  |
|-------------------------|--|
| No sound                | <ol style="list-style-type: none"> <li>1. Press the Mute/Unmute button.</li> <li>2. Adjust the volume.</li> <li>3. Check the audio cable connection (if used).</li> <li>4. If using a computer digital video with embedded audio, ensure the computer speakers are set to external speakers.</li> </ol>                          |
| One speaker only        | <ol style="list-style-type: none"> <li>1. Adjust the sound balance in the menu.</li> <li>2. Check the left and right sound control panel settings of the computer or media player source.</li> <li>3. Check the audio cable connection (if used).</li> <li>4. Ensure the content has two audio channels and not mono.</li> </ol> |

# Maintenance

## General Precautions

- The LED lights used in the modules are susceptible to ESD (Electrostatic discharge). To prevent damage to the LED lights, do not touch them with bare hands or with conductive materials when handling.
- It is recommended to regularly inspect all installed components.
- Do not bring objects close to the ventilation holes of the display. Burns or personal injuries may occur if any body parts are brought too close.
- Be sure to power off and disconnect all cables before moving the display. Moving the display with its cables attached may damage the cables and thus cause fire or electric shock.
- Power off and disconnect the power plug from the wall outlet as a safety precaution before performing any type of cleaning or maintenance.

## Initial Operation

- If a new screen has been stowed for less than three (3) months, it can be used at normal brightness during its first use.
- If a new screen has been stowed for more than three (3) months, the brightness should be set at 30% for its first use and allowed to operate for two (2) hours continuously. After two (2) hours of use, power off for 30 minutes. The new screen is now ready for normal brightness usage.

## Front Panel Cleaning Instructions

- Use cool, compressed air to remove dust when the power is off. If the dust cannot be removed, the LED module should be replaced.
- Do not scratch and do not put pressure on the panel surface with fingers or any abrasive object.
- Do not use volatile substances such as sprays, solvents, or thinners.

## Cabinet Cleaning Instructions

- Do not allow water or detergent to come into contact with the surface of the display. If water or moisture gets inside the unit, a system malfunction or electrical shock may occur.
- Do not scratch and do not put pressure on the cabinet with any abrasive objects of any kind.
- Do not use volatile substances such as sprays, solvents, or thinners on the cabinet.
- Do not place anything made from rubber or PVC near the cabinet for any extended periods of time.

## **Regular Use**

- It is recommended to turn on the display at least once a month for more than eight (8) hours. During a wet and rainy season, it is recommended to turn on the display at least once a week.
- Avoid using full white, full red, full blue, or full green content for an extended period to avoid excessive power usage thus affecting the LED lifespan.

# Vacuum Suction Tool

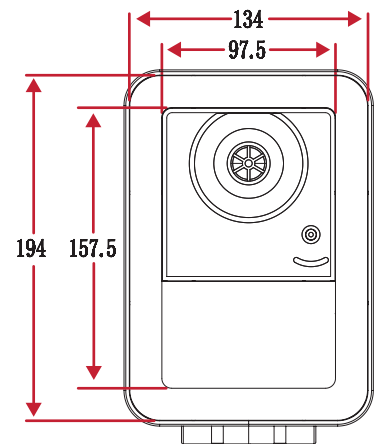
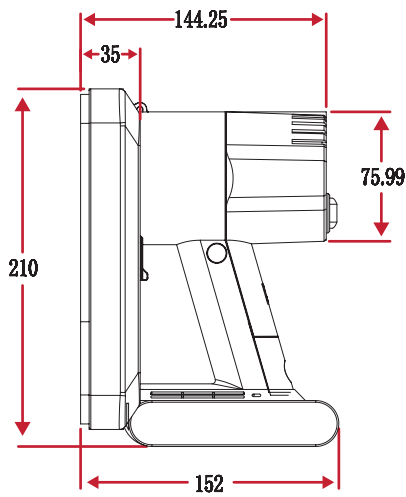
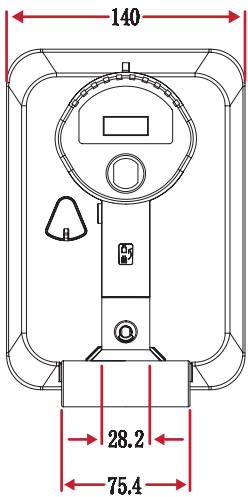
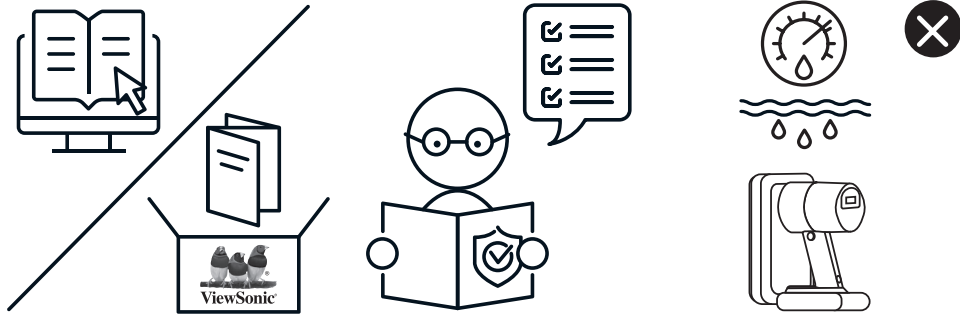

## Charging the Battery

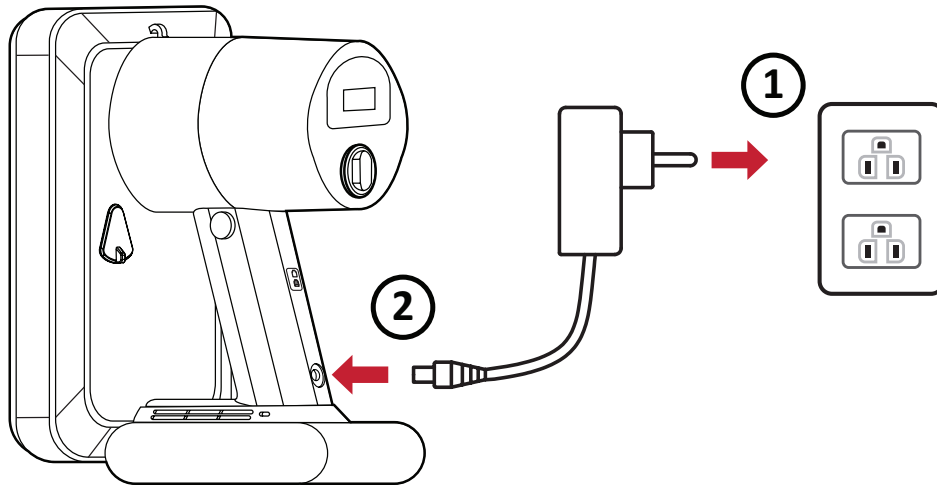

## Changing the Battery

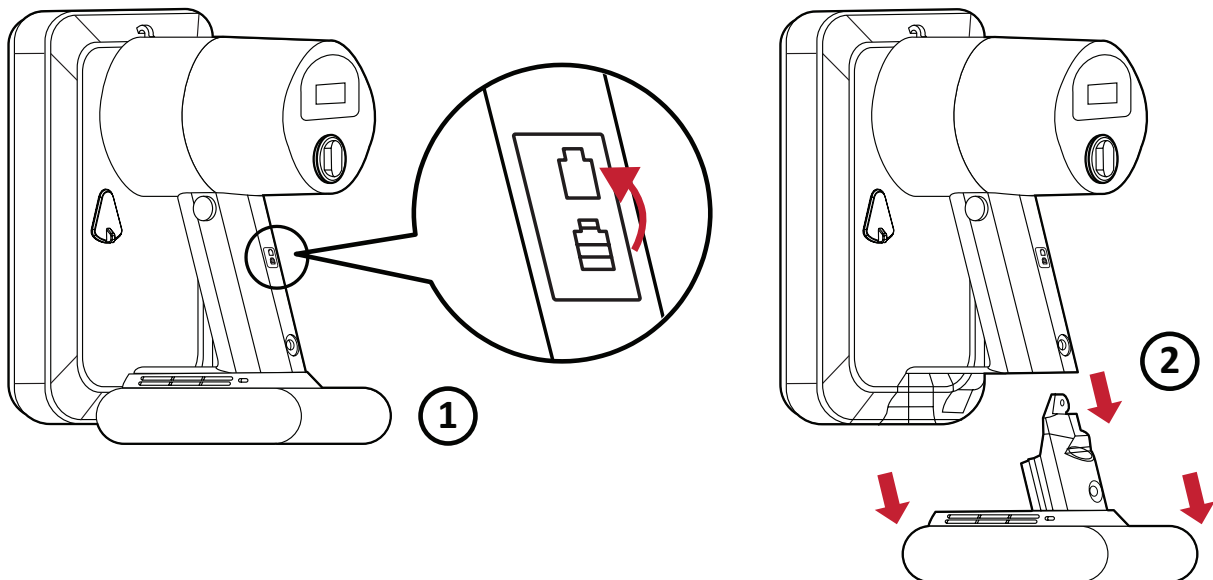

## LED Module Disassembly

①

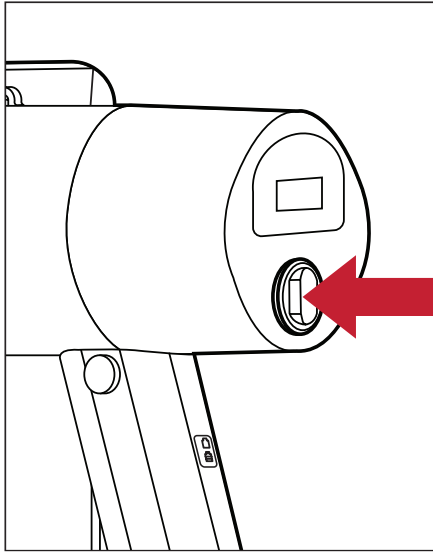

②

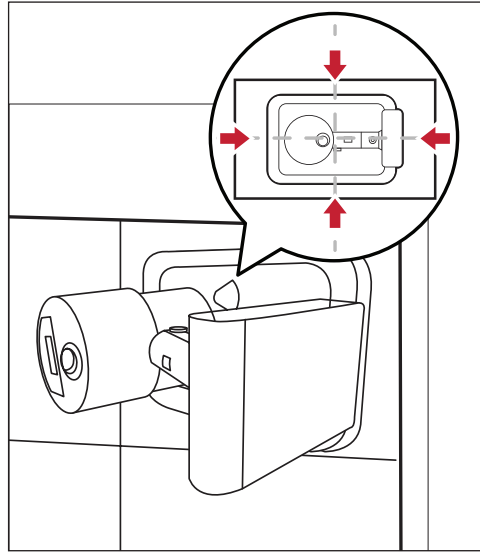

③

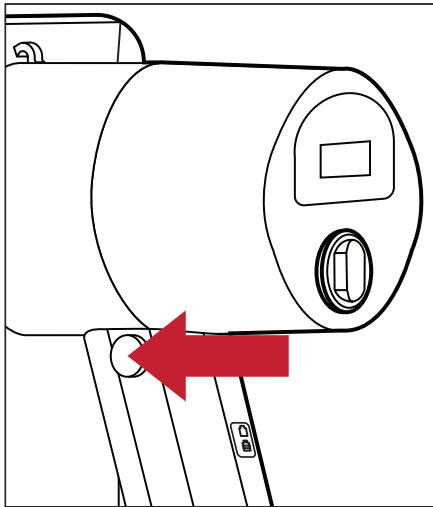

④

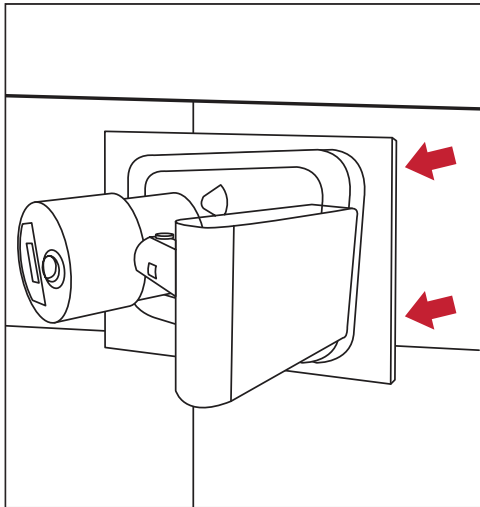

## Overview

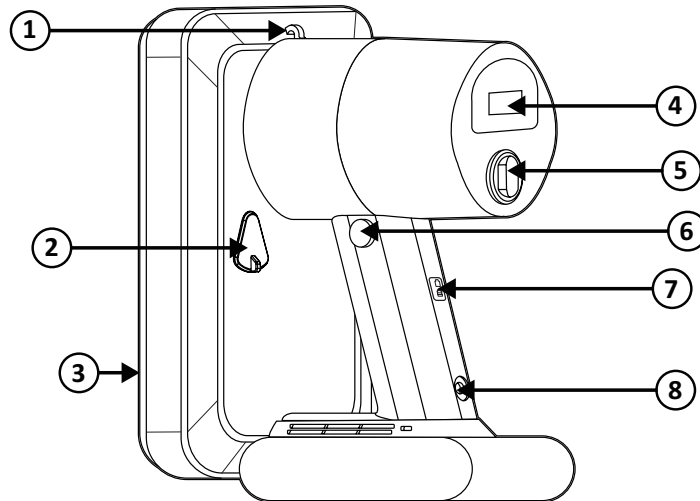

| Number | Item                        | Description  |
|--------|-----------------------------|--|
| ①      | Lanyard Ring                | Lanyard attachment point.  |
| ②      | Regulating Valve            | Adjust the suction force level. Cover the valve for the strongest suction force. |
| ③      | LED Module Contact Silicone | Soft contact surface for LED module removal.                                     |
| ④      | Power Display               | Battery indicator.   |
| ⑤      | Power Switch                | Turn the device On/Off.  |
| ⑥      | Start Button                | Engage/Disengage the suction force.  |
| ⑦      | Battery Removal Button      | Press to remove the battery.   |
| ⑧      | Charging Port               | Port for battery charging.   |

## Specifications

| Item                          | Description   |
|-------------------------------|---|
| <b>Model</b>                  | LD-MK-001   |
| <b>Suction Face Dimension</b> | 134 x 194 mm<br>(5.27" x 7.64")                                 |
| <b>Available Module Size</b>  | 192 x 192 to 500 x 500 mm<br>(7.56" x 7.56" to 19.69" x 19.69") |
| <b>Product Dimension</b>      | 152 x 140 x 210 mm<br>(5.98" x 5.51" x 8.27")                   |
| <b>Weight</b>                 | 1.17 kg<br>(2.58 lbs)   |
| <b>Working Duration</b>       | 17 minutes  |
| <b>Working Temperature</b>    | 3 to 55° C (37.4 to 131° F)                                     |

# > RS-232 Protocol

This document describes the hardware interface and software protocols of RS-232 serial communication between the ViewSonic LED Display and computers or control systems.

## RS-232 Hardware Specification

ViewSonic RS-232 serial port on the lower left side:

1. Connector type: DB 9-Pin Female
2. Use of straight-through parallel cable for connection
3. Pin Assignment:

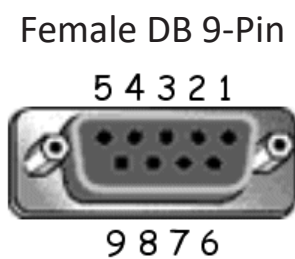

| Pin # | Signal | Remark              |
|-------|--------|---------------------|
| 1     | NC     |                     |
| 2     | TXD    | Output from Display |
| 3     | RXD    | Input to Display    |
| 4     | NC     |                     |
| 5     | GND    | GND                 |
| 6     | NC     |                     |
| 7     | NC     |                     |
| 8     | NC     |                     |
| 9     | NC     |                     |
| frame | GND    |                     |

## RS-232 Communication Setting

- Baud Rate Select: 115200bps (fixed)
- Data bits: 8 bits (fixed)
- Parity: None (fixed)
- Stop Bits: 1(fixed)



## Command Table

| Function              | Command Code (Hex) | HEX                        | Data Range |
|-----------------------|--------------------|----------------------------|------------|
| Power On              | 21                 | 38 30 31 73 21 30 30 31 0D |            |
| Power Off (Standby)   | 21                 | 38 30 31 73 21 30 30 30 0D |            |
| Get-Power Status      | 6C                 | 38 30 31 67 6C 30 30 30 0D |            |
| Input Select: HDMI 1  | 22                 | 38 30 31 73 22 30 30 34 0D |            |
| Input Select: HDMI 2  | 22                 | 38 30 31 73 22 30 31 34 0D |            |
| Get-Input Select      | 6A                 | 38 30 31 67 6A 30 30 30 0D |            |
| Input Select: Home    | 22                 | 38 30 31 73 22 30 30 41 0D |            |
| Brightness: Down (-1) | 24                 | 38 30 31 73 24 39 30 30 0D |            |
| Brightness: Up (+1)   | 24                 | 38 30 31 73 24 39 30 31 0D |            |
| Volume: Down (-1)     | 35                 | 38 30 31 73 35 39 30 30 0D |            |
| Volume: Up (+1)       | 35                 | 38 30 31 73 35 39 30 31 0D |            |
| Get-Volume            | 66                 | 38 30 31 67 66 30 30 30 0D |            |
| Mute: OFF             | 36                 | 38 30 31 73 36 30 30 30 0D |            |
| Mute: ON (mute)       | 36                 | 38 30 31 73 36 30 30 31 0D |            |
| Get-Mute              | 67                 | 38 30 31 67 67 30 30 30 0D |            |
| Number (0~9)          | 40                 | 38 30 31 73 40 30 30 3x 0D | x = 0~9    |
| Key Pad: UP           | 41                 | 38 30 31 73 41 30 30 30 0D |            |
| Key Pad: DOWN         | 41                 | 38 30 31 73 41 30 30 31 0D |            |
| Key Pad: LEFT         | 41                 | 38 30 31 73 41 30 30 32 0D |            |
| Key Pad: RIGHT        | 41                 | 38 30 31 73 41 30 30 33 0D |            |
| Key Pad: ENTER        | 41                 | 38 30 31 73 41 30 30 34 0D |            |
| Key Pad: INPUT        | 41                 | 38 30 31 73 41 30 30 35 0D |            |
| Key Pad: MENU         | 41                 | 38 30 31 73 41 30 30 36 0D |            |
| Key Pad: EXIT         | 41                 | 38 30 31 73 41 30 30 37 0D |            |
| Get-Operational Hours | 31                 | 38 30 31 67 31 30 30 30 0D |            |

# > Regulatory and Service Information

## Compliance Information

This section addresses all connected requirements and statements regarding regulations. Confirmed corresponding applications shall refer to nameplate labels and relevant markings on the unit.

### FCC Compliance Statement

This device complies with part 15 of FCC Rules. Operation is subject to the following two conditions: (1) this device may not cause harmful interference, and (2) this device must accept any interference received, including interference that may cause undesired operation. This equipment has been tested and found to comply with the limits for a Class B digital device, pursuant to part 15 of the FCC Rules.

These limits are designed to provide reasonable protection against harmful interference in a residential installation. This equipment generates, uses, and can radiate radio frequency energy, and if not installed and used in accordance with the instructions, may cause harmful interference to radio communications. However, there is no guarantee that interference will not occur in a particular installation. If this equipment does cause harmful interference to radio or television reception, which can be determined by turning the equipment off and on, the user is encouraged to try to correct the interference by one or more of the following measures:

- Reorient or relocate the receiving antenna.
- Increase the separation between the equipment and receiver.
- Connect the equipment into an outlet on a circuit different from that to which the receiver is connected.
- Consult the dealer or an experienced radio/TV technician for help.

The antenna(s) used for this transmitter must not be collocated or operating in conjunction with any other antenna or transmitter.

The device was tested and complies to measurement standards and procedures specified in FCC CFR Title 47 Part 15 Subpart C.

## **FCC Radiation Exposure Statement**

This equipment complies with FCC radiation exposure limits set forth for an uncontrolled environment. End users must follow the specific operating instructions for satisfying RF exposure compliance.

This transmitter must not be co-located or operating in conjunction with any other antenna or transmitter. This equipment should be installed and operated with a minimum distance of 20 centimeters between the radiator and your body.

The users manual or instruction manual for an intentional or unintentional radiator shall caution the user that changes or modifications not expressly approved by the party responsible for compliance could void the user's authority to operate the equipment.

**Warning:** You are cautioned that changes or modifications not expressly approved by the party responsible for compliance could void your authority to operate the equipment.

## **IC Warning Statement**

This device complies with Industry Canada license- exempt RSS standard(s). Operation is subject to the following two conditions: (1) this device may not cause interference, and (2) this device must accept any interference, including interference that may cause undesired operation of the device.

Le présent appareil est conforme aux CNR d'Industrie Canada applicables aux appareils radio exempts de licence. L'exploitation est autorisée aux deux conditions suivantes : ( 1 ) l'appareil ne doit pas produire de brouillage, et ( 2 ) l'utilisateur de l'appareil doit accepter tout brouillage radioélectrique subi, même si le brouillage est susceptible d'en compromettre le fonctionnement.

## **Country Code Statement**

For product available in the USA/Canada market, only channel 1~11 can be operated. Selection of other channels is not possible.

Pour les produits disponibles aux États-Unis/Canada du marché, seul le canal 1 à 11 peuvent être exploités. Sélection d'autres canaux n'est pas possible.

## IC Radiation Exposure Statement

This equipment complied with IC RSS-102 radiation exposure limits set forth for an uncontrolled environment. This equipment should be installed and operated with minimum distance 20cm between the radiator & your body. The device for the band 5150-5825 MHz is only for indoor usage to reduce potential for harmful interference to co-channel mobile satellite systems.

Cet équipement est conforme aux limites d'exposition aux rayonnements IC établies pour un environnement non contrôlé. Cet équipement doit être installé et utilisé avec un minimum de 20cm de distance entre la source de rayonnement et votre corps. Les dispositifs fonctionnant dans la bande 5150-5825 MHz sont réservés uniquement pour une utilisation à l'intérieur afin de réduire les risques de brouillage préjudiciable aux systèmes de satellites mobiles utilisant les mêmes canaux.

## CE Conformity for European Countries

 The device complies with the EMC Directive 2014/30/EU and Low Voltage Directive 2014/35/EU.

### The following information is only for EU-member states:

The mark shown to the right is in compliance with the Waste Electrical and Electronic Equipment Directive 2012/19/EU (WEEE). The mark indicates the requirement NOT to dispose of the equipment as unsorted municipal waste, but use the return and collection systems according to local law.



## Declaration of RoHS2 Compliance

This product has been designed and manufactured in compliance with Directive 2011/65/EU of the European Parliament and the Council on restriction of the use of certain hazardous substances in electrical and electronic equipment (RoHS2 Directive) and is deemed to comply with the maximum concentration values issued by the European Technical Adaptation Committee (TAC) as shown below:

| Substance                               | Proposed Maximum Concentration | Actual Concentration |
|---|--------------------------------|----------------------|
| Lead (Pb)                               | 0.1%                           | < 0.1%               |
| Mercury (Hg)                            | 0.1%                           | < 0.1%               |
| Cadmium (Cd)                            | 0.01%                          | < 0.01%              |
| Hexavalent Chromium (Cr6 <sup>+</sup> ) | 0.1%                           | < 0.1%               |
| Polybrominated biphenyls (PBB)          | 0.1%                           | < 0.1%               |
| Polybrominated diphenyl ethers (PBDE)   | 0.1%                           | < 0.1%               |
| Bis (2-ethylhexyl) phthalate (DEHP)     | 0.1%                           | < 0.1%               |
| Butyl benzyl phthalate (BBP)            | 0.1%                           | < 0.1%               |
| Dibutyl phthalate (DBP)                 | 0.1%                           | < 0.1%               |
| Diisobutyl phthalate (DIBP)             | 0.1%                           | < 0.1%               |

### Certain components of products as stated above are exempted under the Annex III of the RoHS2 Directives as noted below:

- Copper alloy containing up to 4% lead by weight.
- Lead in high melting temperature type solders (i.e. lead-based alloys containing 85% by weight or more lead).
- Electrical and electronic components containing lead in a glass or ceramic other than dielectric ceramic in capacitors, e.g. piezoelectronic devices, or in a glass or ceramic matrix compound.
- Lead in dielectric ceramic in capacitors for a rated voltage of 125V AC or 250V DC or higher.

### European Union Regulatory Conformance

The equipment complies with the RF Exposure Requirement 2014/53/EU, Council Recommendation of 16 April 2014 on the limitation of exposure of the general public to electromagnetic fields (0-300 GHz). This equipment meets the following conformance standards: EN301489-1, EN301489-17, EN62368-1, EN300328.

We, hereby, declare that this Wi-Fi radio is in compliance with the essential requirements and other relevant provisions of Directive 2014/53/EU.

## **Indian Restriction of Hazardous Substances**

Restriction on Hazardous Substances statement (India). This product complies with the “India E-waste Rule 2011” and prohibits use of lead, mercury, hexavalent chromium, polybrominated biphenyls or polybrominated diphenyl ethers in concentrations exceeding 0.1 weight % and 0.01 weight % for cadmium, except for the exemptions set in Schedule 2 of the Rule.

## **Product Disposal at End of Product Life**

ViewSonic® respects the environment and is committed to working and living green. Thank you for being part of Smarter, Greener Computing. Please visit the ViewSonic® website to learn more.

### **USA & Canada:**

<http://www.viewsonic.com/company/green/recycle-program/>

### **Europe:**

<http://www.viewsoniceurope.com/eu/support/call-desk/>

### **Taiwan:**

<https://recycle.epa.gov.tw/>

## Copyright Information

Copyright© ViewSonic® Corporation, 2021. All rights reserved.

Macintosh and Power Macintosh are registered trademarks of Apple Inc.

Microsoft, Windows, and the Windows logo are registered trademarks of Microsoft Corporation in the United States and other countries.

ViewSonic®, the three birds logo, OnView, ViewMatch, and ViewMeter are registered trademarks of ViewSonic® Corporation.

VESA is a registered trademark of the Video Electronics Standards Association. DPMS, DisplayPort, and DDC are trademarks of VESA.

CTA is a registered trademark of the Consumer Technology Association Standards.

**Disclaimer:** ViewSonic® Corporation shall not be liable for technical or editorial errors or omissions contained herein; nor for incidental or consequential damages resulting from furnishing this material, or the performance or use of this product.

In the interest of continuing product improvement, ViewSonic® Corporation reserves the right to change product specifications without notice. Information in this document may change without notice.

No part of this document may be copied, reproduced, or transmitted by any means, for any purpose without prior written permission from ViewSonic® Corporation.

## Customer Service

For technical support or product service, see the table below or contact your reseller.

**NOTE:** You will need the product's serial number.

| Country/ Region                  | Website  | Country/ Region          | Website  |
|----------------------------------|--|--------------------------|--|
| <b>Asia Pacific &amp; Africa</b> |  |                          |  |
| Australia                        | <a href="http://www.viewsonic.com/au/">www.viewsonic.com/au/</a>       | Bangladesh               | <a href="http://www.viewsonic.com/bd/">www.viewsonic.com/bd/</a> |
| 中国 (China)                       | <a href="http://www.viewsonic.com.cn">www.viewsonic.com.cn</a>         | 香港 (繁體中文)                | <a href="http://www.viewsonic.com/hk/">www.viewsonic.com/hk/</a> |
| Hong Kong (English)              | <a href="http://www.viewsonic.com/hk-en/">www.viewsonic.com/hk-en/</a> | India                    | <a href="http://www.viewsonic.com/in/">www.viewsonic.com/in/</a> |
| Indonesia                        | <a href="http://www.viewsonic.com/id/">www.viewsonic.com/id/</a>       | Israel                   | <a href="http://www.viewsonic.com/il/">www.viewsonic.com/il/</a> |
| 日本 (Japan)                       | <a href="http://www.viewsonic.com/jp/">www.viewsonic.com/jp/</a>       | Korea                    | <a href="http://www.viewsonic.com/kr/">www.viewsonic.com/kr/</a> |
| Malaysia                         | <a href="http://www.viewsonic.com/my/">www.viewsonic.com/my/</a>       | Middle East              | <a href="http://www.viewsonic.com/me/">www.viewsonic.com/me/</a> |
| Myanmar                          | <a href="http://www.viewsonic.com/mm/">www.viewsonic.com/mm/</a>       | Nepal                    | <a href="http://www.viewsonic.com/np/">www.viewsonic.com/np/</a> |
| New Zealand                      | <a href="http://www.viewsonic.com/nz/">www.viewsonic.com/nz/</a>       | Pakistan                 | <a href="http://www.viewsonic.com/pk/">www.viewsonic.com/pk/</a> |
| Philippines                      | <a href="http://www.viewsonic.com/ph/">www.viewsonic.com/ph/</a>       | Singapore                | <a href="http://www.viewsonic.com/sg/">www.viewsonic.com/sg/</a> |
| 臺灣 (Taiwan)                      | <a href="http://www.viewsonic.com/tw/">www.viewsonic.com/tw/</a>       | ประเทศไทย                | <a href="http://www.viewsonic.com/th/">www.viewsonic.com/th/</a> |
| Việt Nam                         | <a href="http://www.viewsonic.com/vn/">www.viewsonic.com/vn/</a>       | South Africa & Mauritius | <a href="http://www.viewsonic.com/za/">www.viewsonic.com/za/</a> |
| <b>Americas</b>                  |  |                          |  |
| United States                    | <a href="http://www.viewsonic.com/us">www.viewsonic.com/us</a>         | Canada                   | <a href="http://www.viewsonic.com/us">www.viewsonic.com/us</a>   |
| Latin America                    | <a href="http://www.viewsonic.com/la">www.viewsonic.com/la</a>         |                          |  |
| <b>Europe</b>                    |  |                          |  |
| Europe                           | <a href="http://www.viewsonic.com/eu/">www.viewsonic.com/eu/</a>       | France                   | <a href="http://www.viewsonic.com/fr/">www.viewsonic.com/fr/</a> |
| Deutschland                      | <a href="http://www.viewsonic.com/de/">www.viewsonic.com/de/</a>       | Қазақстан                | <a href="http://www.viewsonic.com/kz/">www.viewsonic.com/kz/</a> |
| Россия                           | <a href="http://www.viewsonic.com/ru/">www.viewsonic.com/ru/</a>       | España                   | <a href="http://www.viewsonic.com/es/">www.viewsonic.com/es/</a> |
| Türkiye                          | <a href="http://www.viewsonic.com/tr/">www.viewsonic.com/tr/</a>       | Україна                  | <a href="http://www.viewsonic.com/ua/">www.viewsonic.com/ua/</a> |
| United Kingdom                   | <a href="http://www.viewsonic.com/uk/">www.viewsonic.com/uk/</a>       |                          |  |



## Limited Warranty

### ViewSonic® Commercial Display

#### What the warranty covers:

ViewSonic® warrants its products to be free from defects in material and workmanship during the warranty period. If a product proves to be defective in material or workmanship during the warranty period, ViewSonic® will, at its sole option, and as your sole remedy, repair or replace the product with a similar product. Replacement Product or parts may include remanufactured or refurbished parts or components. The repair or replacement unit or parts or components will be covered by the balance of the time remaining on the customer's original limited warranty and the warranty period will not be extended. ViewSonic® provides no warranty for any third-party software whether included with the product or installed by the customer, installation of any unauthorized hardware parts or components (e.g. Projector Lamps). (Please refer to: "What the warranty excludes and does not cover" section).

#### Who the warranty protects:

This warranty is valid only for the first consumer purchaser.

#### What the warranty excludes and does not cover:

- Any product on which the serial number has been defaced, modified, or removed.
- Damage, deterioration, or malfunction resulting from:
  - » Accident, misuse, neglect, fire, water, lightning, or other acts of nature, unauthorized product modification, or failure to follow instructions supplied with the product.
  - » Repair or attempted repair by anyone not authorized by ViewSonic®.
  - » Damage to or loss of any programs, data, or removable storage media.
  - » Normal wear and tear.
  - » Removal or installation of the product.
- Software or data loss occurring during repair or replacement.
- Any damage of the product due to shipment.
- Causes external to the product, such as electric power fluctuations or failure.
- Use of supplies or parts not meeting ViewSonic's specifications.
- Failure of owner to perform periodic product maintenance as stated in the User Guide.
- Any other cause which does not relate to a product defect.

- Damage caused by static (non-moving) images displayed for lengthy periods of time (also referred to as image burn-in).
- Software - Any third-party software included with the product or installed by the customer.
- Hardware/Accessories/Parts/Components – Installation of any unauthorized hardware, accessories, consumable parts or components (e.g. Projector Lamps).
- Damage to, or abuse of, the coating on the surface of the display through inappropriate cleaning as described in the product User Guide.
- Removal, installation, and set-up service charges, including wall-mounting of the product.

### **How to get service:**

- For information about receiving service under warranty, contact ViewSonic® Customer Support (Please refer to the “Customer Service” page). You will need to provide your product’s serial number.
- To obtain warranty service, you will be required to provide: (a) the original dated sales slip, (b) your name, (c) your address, (d) a description of the problem, and (e) the serial number of the product.
- Take or ship the product, freight prepaid, in the original container to an authorized ViewSonic® service center or ViewSonic®.
- For additional information or the name of the nearest ViewSonic® service center, contact ViewSonic®.

### **Limitation of implied warranties:**

There are no warranties, express or implied, which extend beyond the description contained herein including the implied warranty of merchantability and fitness for a particular purpose.

**Exclusion of damages:**

ViewSonic's liability is limited to the cost of repair or replacement of the product. ViewSonic® shall not be liable for:

- Damage to other property caused by any defects in the product, damages based upon inconvenience, loss of use of the product, loss of time, loss of profits, loss of business opportunity, loss of goodwill, interference with business relationships, or other commercial loss, even if advised of the possibility of such damages.
- Any other damages, whether incidental, consequential or otherwise.
- Any claim against the customer by any other party.
- Repair or attempted repair by anyone not authorized by ViewSonic®.

**Effect of state law:**

This warranty gives you specific legal rights, and you may also have other rights which vary from state to state. Some states do not allow limitations on implied warranties and/or do not allow the exclusion of incidental or consequential damages, so the above limitations and exclusions may not apply to you.

**Sales outside the U.S.A. and Canada:**

For warranty information and service on ViewSonic® products sold outside of the U.S.A. and Canada, contact ViewSonic® or your local ViewSonic® dealer.

The warranty period for this product in mainland China (Hong Kong, Macao, and Taiwan Excluded) is subject to the terms and conditions of the Maintenance Guarantee Card.

For users in Europe and Russia, full details of warranty provided can be found at: <http://www.viewsonic.com/eu/> under "Support/Warranty Information".

## **Mexico Limited Warranty**

### ViewSonic® Commercial Display

#### **What the warranty covers:**

ViewSonic® warrants its products to be free from defects in material and workmanship, under normal use, during the warranty period. If a product proves to be defective in material or workmanship during the warranty period, ViewSonic® will, at its sole option, repair or replace the product with a like product. Replacement product or parts may include remanufactured or refurbished parts or components & accessories.

#### **Who the warranty protects:**

This warranty is valid only for the first consumer purchaser.

#### **What the warranty excludes and does not cover:**

- Any product on which the serial number has been defaced, modified or removed.
- Damage, deterioration, or malfunction resulting from:
  - » Accident, misuse, neglect, fire, water, lightning, or other acts of nature, unauthorized product modification, unauthorized attempted repair, or failure to follow instructions supplied with the product.
  - » Causes external to the product, such as electrical power fluctuations or failure.
  - » Use of supplies or parts not meeting ViewSonic®'s specifications.
  - » Normal wear and tear.
  - » Any other cause which does not relate to a product defect.
- Any product exhibiting a condition commonly known as “image burn-in” which results when a static image is displayed on the product for an extended period of time.
- Removal, installation, insurance, and set-up service charges.

**How to get service:**

For information about receiving service under warranty, contact ViewSonic® Customer Support (Please refer to the attached “Customer Service” page). You will need to provide your product’s serial number, so please record the product information in the space provided below on your purchase for your future use. Please retain your receipt of proof of purchase to support your warranty claim.

**For Your Records**

Product Name: \_\_\_\_\_ Model Number: \_\_\_\_\_  
Document Number: \_\_\_\_\_ Serial Number: \_\_\_\_\_  
Purchase Date: \_\_\_\_\_ Extended Warranty Purchase? \_\_\_\_\_(Y/N)  
If so, what date does warranty expire? \_\_\_\_\_

- To obtain warranty service, you will be required to provide (a) the original dated sales slip, (b) your name, (c) your address, (d) a description of the problem, and (e) the serial number of the product.
- Take or ship the product, in the original container packaging, to an authorized ViewSonic® service center.
- Round trip transportation costs for in-warranty products will be paid by ViewSonic®.

**Limitation of implied warranties:**

There are no warranties, express or implied, which extend beyond the description contained herein including the implied warranty of merchantability and fitness for a particular purpose.

**Exclusion of damages:**

ViewSonic®’s liability is limited to the cost of repair or replacement of the product. ViewSonic® shall not be liable for:

- Damage to other property caused by any defects in the product, damages based upon inconvenience, loss of use of the product, loss of time, loss of profits, loss of business opportunity, loss of goodwill, interference with business relationships, or other commercial loss, even if advised of the possibility of such damages.
- Any other damages, whether incidental, consequential or otherwise.
- Any claim against the customer by any other party.
- Repair or attempted repair by anyone not authorized by ViewSonic®.

|   |   |
|---|---|
| Contact Information for Sales & Authorized Service (Centro Autorizado de Servicio) within Mexico:   |   |
| <b>Name, address, of manufacturer and importers:</b><br>México, Av. de la Palma #8 Piso 2 Despacho 203, Corporativo Interpalmas,<br>Col. San Fernando Huixquilucan, Estado de México<br>Tel: (55) 3605-1099 <a href="http://www.viewsonic.com/la/soporte/index.htm">http://www.viewsonic.com/la/soporte/index.htm</a> |   |
| NÚMERO GRATIS DE ASISTENCIA TÉCNICA PARA TODO MÉXICO: 001.866.823.2004  |   |
| <b>Hermosillo:</b><br>Distribuciones y Servicios Computacionales SA de CV.<br>Calle Juarez 284 local 2<br>Col. Bugambilias C.P: 83140<br>Tel: 01-66-22-14-9005<br>E-Mail: <a href="mailto:disc2@hmo.megared.net.mx">disc2@hmo.megared.net.mx</a>  | <b>Villahermosa:</b><br>Compumantenimientos Garantizados, S.A. de C.V.<br>AV. GREGORIO MENDEZ #1504<br>COL, FLORIDA C.P. 86040<br>Tel: 01 (993) 3 52 00 47 / 3522074 / 3 52 20 09<br>E-Mail: <a href="mailto:compumantenimientos@prodigy.net.mx">compumantenimientos@prodigy.net.mx</a> |
| <b>Puebla, Pue. (Matriz):</b><br>RENTA Y DATOS, S.A. DE C.V. Domicilio:<br>29 SUR 721 COL. LA PAZ<br>72160 PUEBLA, PUE.<br>Tel: 01(52).222.891.55.77 CON 10 LINEAS<br>E-Mail: <a href="mailto:datos@puebla.megared.net.mx">datos@puebla.megared.net.mx</a>  | <b>Veracruz, Ver.:</b><br>CONEXION Y DESARROLLO, S.A DE C.V. Av.<br>Americas # 419<br>ENTRE PINZÓN Y ALVARADO<br>Fracc. Reforma C.P. 91919<br>Tel: 01-22-91-00-31-67<br>E-Mail: <a href="mailto:gacosta@qplus.com.mx">gacosta@qplus.com.mx</a>  |
| <b>Chihuahua:</b><br>Soluciones Globales en Computación<br>C. Magisterio # 3321 Col. Magisterial<br>Chihuahua, Chih.<br>Tel: 4136954<br>E-Mail: <a href="mailto:Cefeo@soluglobales.com">Cefeo@soluglobales.com</a>  | <b>Cuernavaca:</b><br>Compusupport de Cuernavaca SA de CV<br>Francisco Leyva # 178 Col. Miguel Hidalgo<br>C.P. 62040, Cuernavaca Morelos<br>Tel: 01 777 3180579 / 01 777 3124014<br>E-Mail: <a href="mailto:aquevedo@compusupportcva.com">aquevedo@compusupportcva.com</a>              |
| <b>Distrito Federal:</b><br>QPLUS, S.A. de C.V.<br>Av. Coyoacán 931<br>Col. Del Valle 03100, México, D.F.<br>Tel: 01(52)55-50-00-27-35<br>E-Mail : <a href="mailto:gacosta@qplus.com.mx">gacosta@qplus.com.mx</a>   | <b>Guadalajara, Jal.:</b><br>SERVICRECE, S.A. de C.V.<br>Av. Niños Héroes # 2281<br>Col. Arcos Sur, Sector Juárez<br>44170, Guadalajara, Jalisco<br>Tel: 01(52)33-36-15-15-43<br>E-Mail: <a href="mailto:mmiranda@servicrece.com">mmiranda@servicrece.com</a>                           |
| <b>Guerrero Acapulco:</b><br>GS Computación (Grupo Sesicomp)<br>Progreso #6-A, Colo Centro<br>39300 Acapulco, Guerrero<br>Tel: 744-48-32627   | <b>Monterrey:</b><br>Global Product Services<br>Mar Caribe # 1987, Esquina con Golfo Pérsico<br>Fracc. Bernardo Reyes, CP 64280<br>Monterrey N.L. México<br>Tel: 8129-5103<br>E-Mail: <a href="mailto:aydeem@gps1.com.mx">aydeem@gps1.com.mx</a>  |
| <b>MERIDA:</b><br>ELECTROSER<br>Av Reforma No. 403Gx39 y 41<br>Mérida, Yucatán, México CP97000<br>Tel: (52) 999-925-1916<br>E-Mail: <a href="mailto:rrrb@sureste.com">rrrb@sureste.com</a>  | <b>Oaxaca, Oax.:</b><br>CENTRO DE DISTRIBUCION Y<br>SERVICIO, S.A. de C.V.<br>Murguía # 708 P.A., Col. Centro, 68000, Oaxaca<br>Tel: 01(52)95-15-15-22-22<br>Fax: 01(52)95-15-13-67-00<br>E-Mail: <a href="mailto:gpotai2001@hotmail.com">gpotai2001@hotmail.com</a>                    |
| <b>Tijuana:</b><br>STD<br>Av Ferrocarril Sonora #3780 L-C<br>Col 20 de Noviembr<br>Tijuana, Mexico  | <b>FOR USA SUPPORT:</b><br>ViewSonic® Corporation<br>381 Brea Canyon Road, Walnut, CA. 91789 USA<br>Tel: 800-688-6688<br>E-Mail: <a href="http://www.viewsonic.com">http://www.viewsonic.com</a>  |



**ViewSonic®**