

ViewSonic®



VX2778-hd-PRO

显示器

使用手册

VS17863

P/N: VX2778-HD-PRO

感谢您选择 ViewSonic

ViewSonic
ViewSonic

View-

Sonic

ViewSonic



目录

1. 注意事项与警告	1
2. 准备使用	3
2-1.	4
2-2.	5
2-3.	6
2-4.	8
2-5.	10
3. 调整屏幕图像	11
3-1.	11
3-2.	12
4. OSD菜单介绍	14
4-1. OSD	14
4-2. OSD	20
4-3.	24
5. 技术规格	25
6. 故障诊断	27
7. 清洁和维护	28
	28

8. 电磁兼容信息..... 30

8-1. FCC 30

8-2. 30

8-3. CE 31

8-4. 32

8-5. 33

9. 版权信息..... 34

10. 服务信息..... 35

..... 35

..... 37

1. 注意事项与警告

- 1.
- 2.
- 3.
- 4.
- 5.
- 6.
- 7.
- 8.
- 9.
- 10.
- 11.
- 12.
- 13.
- 14.
- 15.
- 16.

40-50

:

,

"

"

ViewSonic

17.

18.

19.

/

20.



21.

22.

2. 准备使用

注意: Windows Microsoft Windows

2-1. 包装物品

-
-
- 1
-

NOTE:

1 /

2-2. 显示器外观

A. 正面

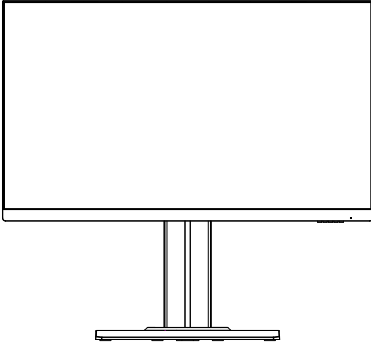

B.

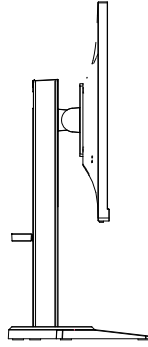

C. 背面

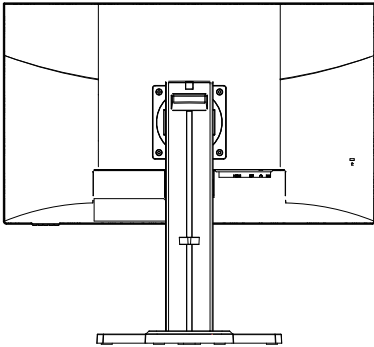

- 1. 3-2
- 2. I/O
I/O
2-4
- 3. Kensington 2-3 D
- 4. VESA *
VESA
2-3 C 124

2-3. 硬件安装

A. 底座连接步骤

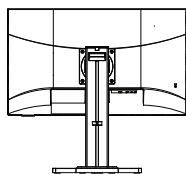

A-1

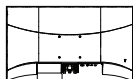

A-2

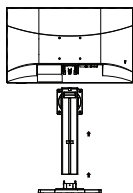

A-3

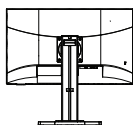

B. 底座卸下步骤

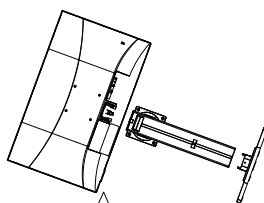

B-1

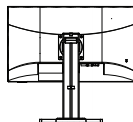

B-2

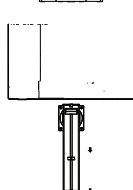

B-3



C. 壁式安装 (可选购)

注意: UL

ViewSonic®

- 1.
- 2.
- 3.
- 4.
- 5.
- 6.

VESA

D. 使用Kensington锁

Kensington

Kensington

<http://www.kensington.com>

Kensington

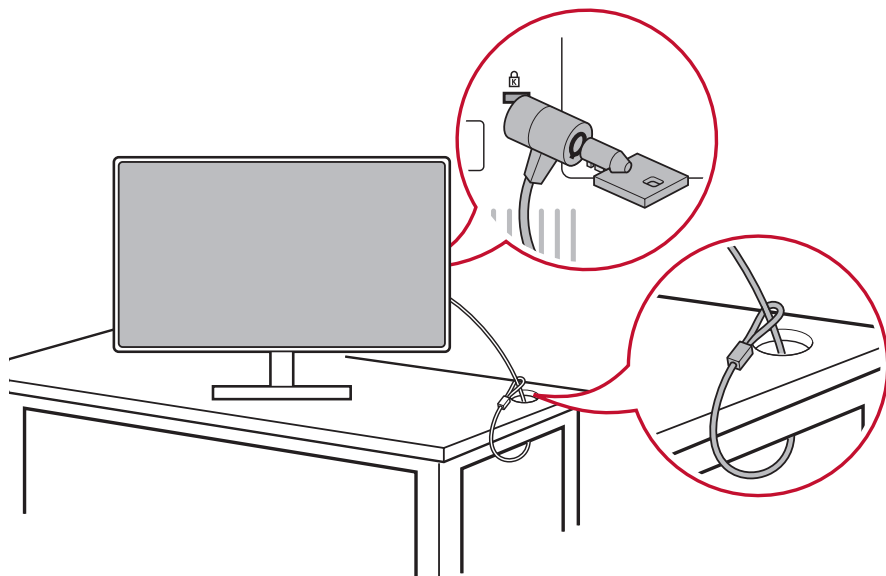

*

2-4. 快速安装

连接视频线

- 1.
- 2.
- 3.

Macintosh

G3

Macintosh

ViewSonic® Macintosh

ViewSonic

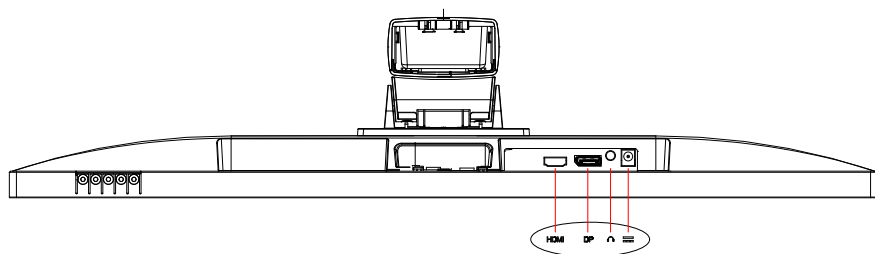

3.A.

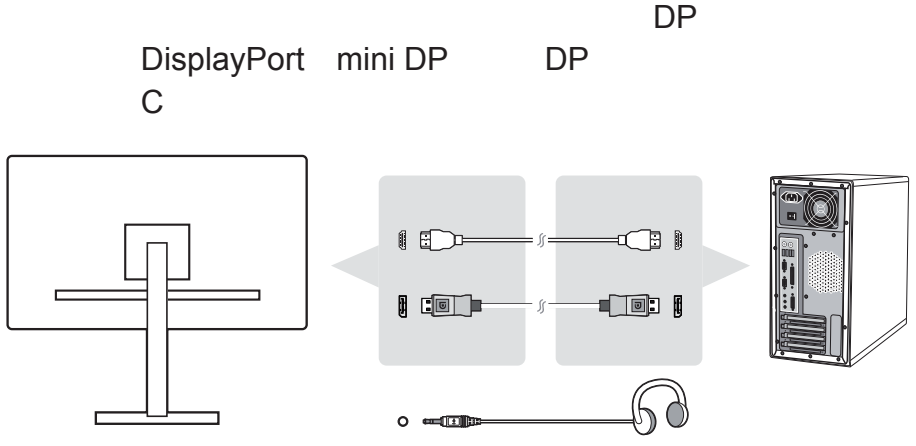

*

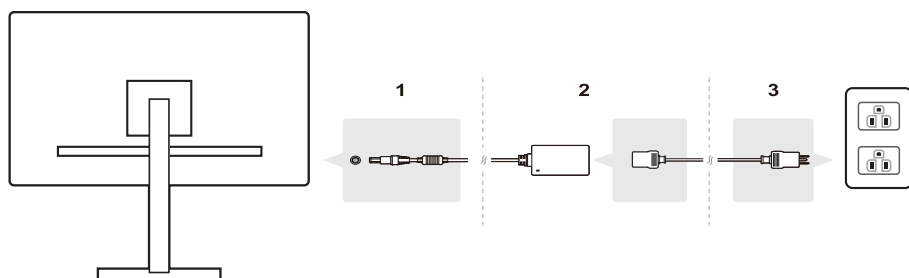

2-5. 电源开启

开启液晶显示器和电脑

3. 调整屏幕图像

3-1. 设置时序模式

1.

2.

1920x1080

•

OSD

OSD
OSD

*

3-2. 使用控制面板

OSD

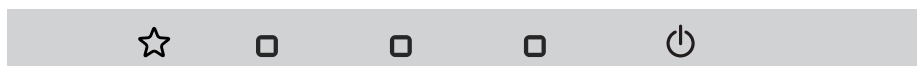

* 2.2

面板和OSD符号说明

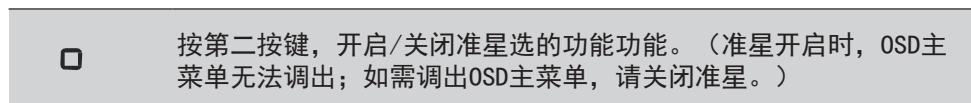
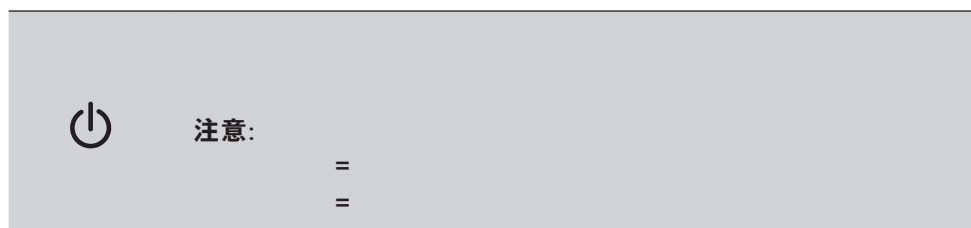

下面介绍OSD菜单和OSD快速菜单符号以及它们的功能。



4. OSD菜单介绍

4-1. OSD菜单树

OSD
OSD
/

OSD

4-2 OSD

OSD

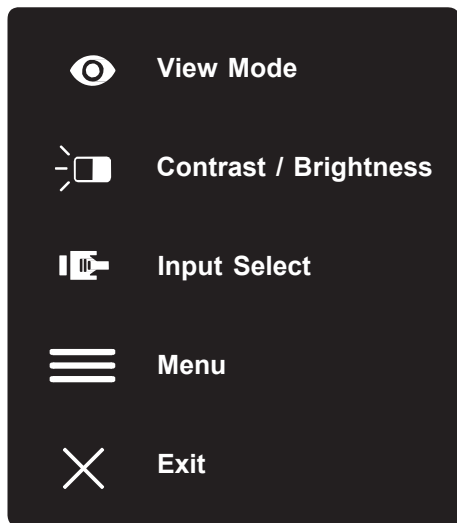

Menu

Startup Menu	ViewMode	Standard	
		FPS Game	
		RTS Game	
		MOBA Game	
		Movie	
		Web	
		Text	
		MAC	
		Mono	
	Audio Adjust	Volume	0~100
	Contrast/Brightness	Contrast	0~100
		Brightness	0~100
	Input Select	HDMI	
		DisplayPort	
	Menu	See the Main Menu OSD table	
	Exit		

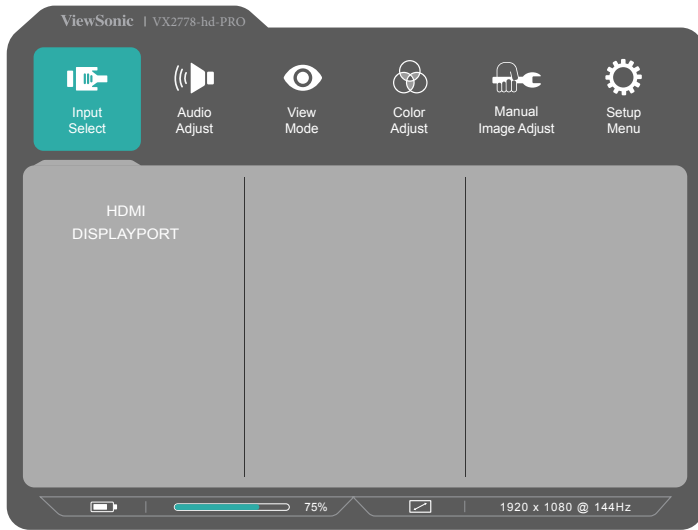

Menu			
Input Select	HDMI		
	DisplayPort		
Audio Adjust	Volume	0~100	
ViewMode	Standard		
	FPS Game		
	RTS Game		
	MOBA Game		
	Movie		
	Web		
	Text		
	MAC		
	Mono		

Menu

Color Adjust	Contrast/Brightness	Contrast	0~100	
		Brightness	0~100	
	Color Temperature	SRGB		
		Bluish		
		Cool		
		Native		
		Warm		
		User Color	Red	0~100
			Green	0~100
	Blue		0~100	
	Color Space	Auto		
		RGB Mode		
		YUV Mode		
	Color Range	Auto		
		Full Range		
		Limited Range		

Menu

Manual Image Adjust	Sharpness	0,25,50,75,100		
	Blue Light Filter	0~100		
	Aspect Ratio	4:3		
		5:4		
		16:9		
		16:10		
	Overscan	On		
		Off		
	Black Stabilization	0,10...50...90,100		
	Advanced DCR	0,25, 50, 75, 100		
	Response Time	Standard		
		Advanced		
Ultra Fast				

Menu

Setup Menu	Language Select	English	
		Français	
		Deutsch	
		Español	
		Italiano	
		Suomi	
		Svenska	
		Русский	
		Türkçe	
		Češka	
		日本語	
		한국의	
		繁體中文	
	简体中文		
	Adaptive-Sync	On,Off	
	Resolution Notice	On,Off	
	Information		
	OSD Timeout	5,15,30,60,	
	OSD Background	On,Off	
	Power Indicator	On,Off	
	Auto Power Off	On,Off	
Sleep	30 Minutes		
	45 Minutes		
	60 Minutes		
	120 Minutes		
	Off		
ECO Mode	Standard , Optimize , Conserve		
Displayport 1.1	On,Off		
Auto Detect	On,Off		
DDC/CI	On,Off		
Memory Recall			

4-2. OSD菜单说明

注意: OSD OSD OSD
OSD OSD OSD
OSD OSD OSD
OSD 4-1 OSD OSD
OSD OSD

A Advanced DCR (高级动态对比度)

Auto Detect (自动检测)

B Black stabilization (黑色稳定)

ViewSonic

Blue light filter (蓝光过滤器)

Brightness (亮度)

C Color adjust (色彩调整)

Color range (颜色范围)

RGB YUV

Color space (色彩空间)

RGB YUV

Color temperature (色温)

sRGB	Windows	Internet
NATIVE		

Contrast (对比度)

Custom ()

Custom

Custom

Custom1 Custom 2

G Game mode (游戏模式)

OSD

FPS RTS MOBA

Main Menu

ViewMode

Game

GAMER

I Information (信息)

ViewSonic®

注意: VESA 1024 x 768 @ 60Hz
60 Hertz

1024 x 768

I Input select (输入信号选择)

ViewSonic

L Low input lag (低输入延迟)

ViewSonic

M Manual image adjust (图像手动调整)

Manual Image Adjust

M Memory recall (恢复设定)

* 例外:

Language Select

Power Lock

O Overscan (过扫描)

R Response time (响应时间)

Ultra Fast

Resolution notice (分辨率提示)

Recall (重新调用)

S Setup menu (设定菜单)

Adjusts On-screen Display OSD

Sharpness (清晰度)

V ViewMode (影像调校)

ViewSonic

Game

Movie

Web

Text

Mono

4-3. 显示器设置管理

OSD Timeout (菜单显示时间)

OSD Timeout

OSD

OSD Background (菜单背景色)

OSD Background
OSD

OSD

Power Indicator (电源指示灯)

Auto Power Off (自动关机)

Auto Power Off

Sleep (休眠)

Eco Mode (Eco模式)

DDC/CI (Display Data Channel Command Interface, 显示数据通道命令接口)

5. 技术规格

显示器	TFT 1920X1080 0.31125 x 0.31125 : 68.6 : 27 (27) RGB
输入信号	HDMI f_h :30-180 kHz, f_v :48-144 Hz DP: f_h :30-180 kHz, f_v :48-144 Hz
兼容性	PC 1920 x 1080 Macintosh ¹ Power Macintosh 1920 x 1080 ()
分辨率 ²	1920X1080@144Hz 1920 x 1080 @ 60 Hz 1680 x 1050 @ 60 Hz 1280 x 1024 @ 60, 75 Hz 1440 x 900 @ 60 Hz 1024 x 768 @ 60, 70, 75 Hz 800 x 600 @ 56, 60, 72, 75 Hz 640 x 480 @ 60, 72, 75 Hz 720 x 400 @ 70 Hz
电源 ³	100-240 VAC, 50/60 Hz ()
显示区域	597.6 x 336.15 23.5 x 13.2

操作条件 温度 +32 ° F 至 +104 ° F (0 ° C 至 +40 ° C)
 湿度 20% 至 90% (无凝结)
 高度 到16000英尺

储存条件 温度 -4° F至+ 140° F (-20° C至+60° C)
 湿度 5%至90% (无凝结)
 高度 到40,000英尺

尺寸 613.4 x 562.9 x 239.2
 24.1 x 22.2 x 9.4

壁挂架

最大负载	孔样式 (宽 x 高; mm)	介面墊 (寬 x 高 x 深)	墊孔	螺絲數量與 規格
14kg	100mm x 100mm	115 mm x 115 mm x 2.6 mm	Ø 5mm	4 piece M4 x 10mm

Weight 15.32 (6.95)

Power saving modes ⁴ 35W ()()
 <0.5W

1 G3 Macintosh ViewSonic Macintosh
 ViewSonic

2

3 ViewSonic®

4 EEI

6. 故障诊断

不通电

-
-
-

电源开启但屏幕无图像

-
-
-

G3

Macintosh

Macintosh

颜色错误或反常

-
-
-

DDC

ViewSonic®

控制按钮不工作

-

7. 清洁和维护

如何清洁显示器

-
-

清洁屏幕:

- 1.
- 2.

清洁外壳:

- 1.
- 2.

免责声明

- ViewSonic®

/

- ViewSonic

小心:

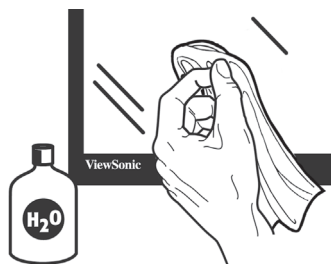
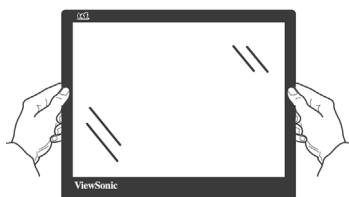

8. 电磁兼容信息

注意:

8-1. FCC 符合性声明

FCC 15

1

2

FCC

B

-
-
-
- /

警告:

8-2. 加拿大工业部声明

CAN ICES-3 (B)/NMB-3(B)

8-3. 针对欧盟国家的 CE 符合性



2014/30/EU

2014/35/

以下信息仅适用于欧盟（EU）成员国：

2012/19/EU

WEEE



8-4. 电子电气产品有害物质限制使用标识要求

部件名称	有害物质					
	铅 (Pb)	汞 (Hg)	镉 (Cd)	六价铬 (Cr6+)	多溴联苯 (PBB)	多溴联苯醚 (PBDE)
	×					
/	×					
	×					
	×					
SJ/T 11364						
GB/T26572						
GB/T26572						

环保使用期限说明



10



8-5. 产品达到使用寿命后废弃产品

ViewSonic

Smarter Greener Computing

ViewSonic

美国和加拿大:

<http://www.viewsonic.com/company/green/recycle-program/>

欧洲: <http://www.viewsoniceurope.com/eu/support/call-desk/>

台湾: <http://recycle.epa.gov.tw/recycle/index2.aspx>

9. 版权信息

© ViewSonic® Corporation, 2019

Macintosh Power Macintosh Apple Inc.

Microsoft Windows Window Microsoft Corporation

ViewSonic OnView ViewMatch ViewMeter
ViewSonic Corporation

VESA VESA DPMS
DisplayPort DDC VESA

ENERGY STAR® EPA

ENERGY STAR® ViewSonic Corporation

ENERGY STAR®

: ViewSonic Corporation

ViewSonic Corporation

ViewSonic Corporation



10. 服务信息

客户支持

注意:

Country/ Region	Website	Country/ Region	Website
Asia Pacific & Africa			
Australia	www.viewsonic.com/au/	Bangladesh	www.viewsonic.com/bd/
中国 (China)	www.viewsonic.com.cn	香港 (繁體中文)	www.viewsonic.com/hk/
Hong Kong (English)	www.viewsonic.com/hk-en/	India	www.viewsonic.com/in/
Indonesia	www.viewsonic.com/id/	Israel	www.viewsonic.com/il/
日本 (Japan)	www.viewsonic.com/jp/	Korea	www.viewsonic.com/kr/
Malaysia	www.viewsonic.com/my/	Middle East	www.viewsonic.com/me/
Myanmar	www.viewsonic.com/mm/	Nepal	www.viewsonic.com/np/
New Zealand	www.viewsonic.com/nz/	Pakistan	www.viewsonic.com/pk/
Philippines	www.viewsonic.com/ph/	Singapore	www.viewsonic.com/sg/
臺灣 (Taiwan)	www.viewsonic.com/tw/	ประเทศไทย	www.viewsonic.com/th/
Việt Nam	www.viewsonic.com/vn/	South Africa & Mauritius	www.viewsonic.com/za/
Americas			
United States	www.viewsonic.com/us	Canada	www.viewsonic.com/us
Latin America	www.viewsonic.com/la		
Europe			
Europe	www.viewsonic.com/eu/	France	www.viewsonic.com/fr/

Country/ Region	Website	Country/ Region	Website
Deutschland	www.viewsonic.com/de/	Қазақстан	www.viewsonic.com/kz/
Россия	www.viewsonic.com/ru/	Espanña	www.viewsonic.com/es/
Türkiye	www.viewsonic.com/tr/	Україна	www.viewsonic.com/ua/
United Kingdom	www.viewsonic.com/uk/		

有限保修

ViewSonic® 显示器

保修范围:

ViewSonic

ViewSonic

保修有效期:

ViewSonic

1 3

受保对象:

不在保修范围内的事项:

1.

2.

:

a.

b.

c.

d.

e.

ViewSonic

f.

g.

3.

"

4.

如何获得服务:

1. ViewSonic.
2. (a) (b) (c) (d) (e)
3. ViewSonic ViewSonic
4. ViewSonic

隐含保修的限制:

损失免责条款:

- ViewSonic ViewSonic
- :
1. ViewSonic
 - 2.
 - 3.
 4. ViewSonic

州法律的效力（美国）：

/

美国和加拿大以外地区销售的产品：

ViewSonic

ViewSonic
ViewSonic

Support/Warranty Information

www.viewsoniceurope.com

/



ViewSonic®