

REV.	DESCRIPTION	SIGN.	DATE
△			
△			

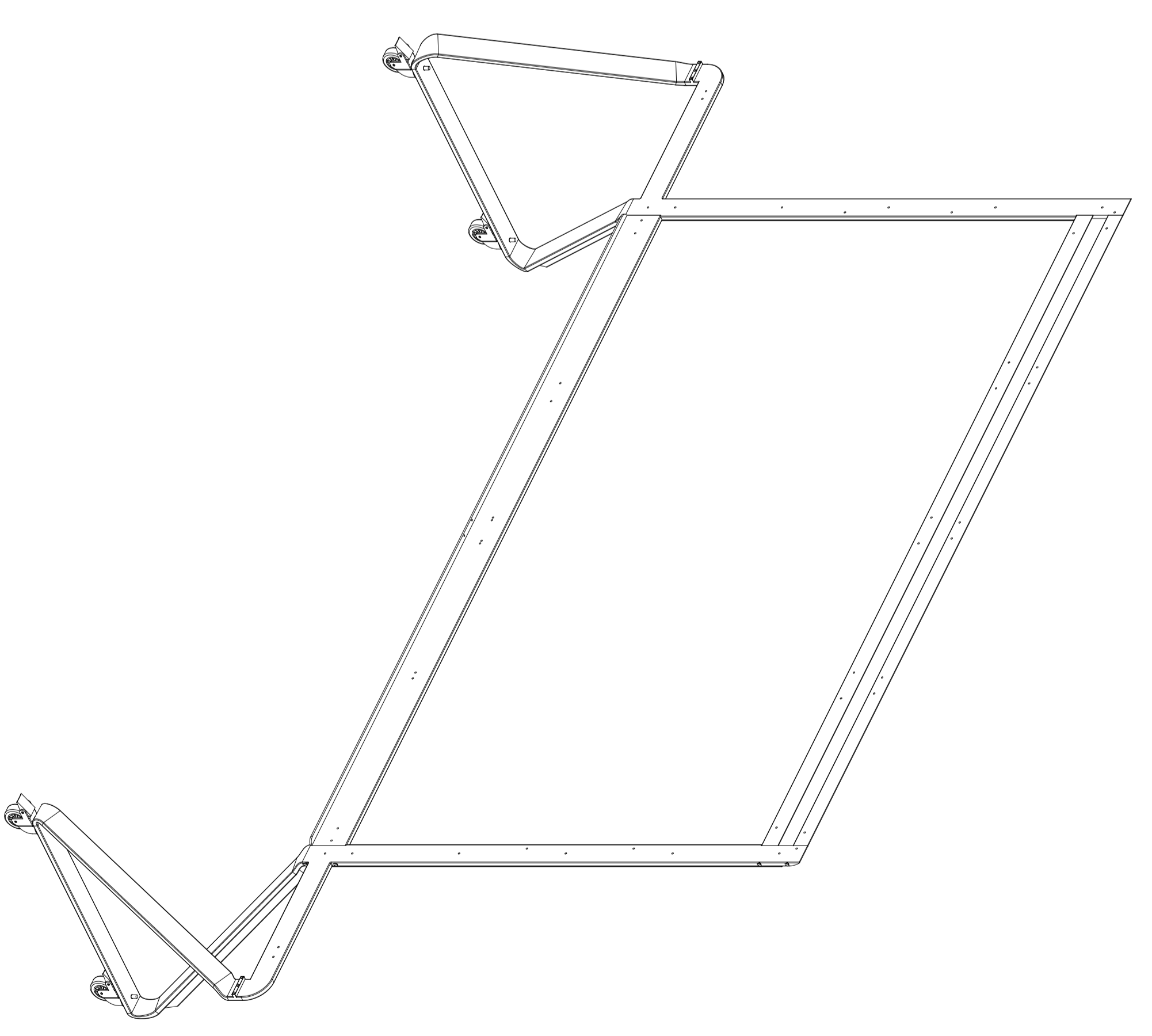
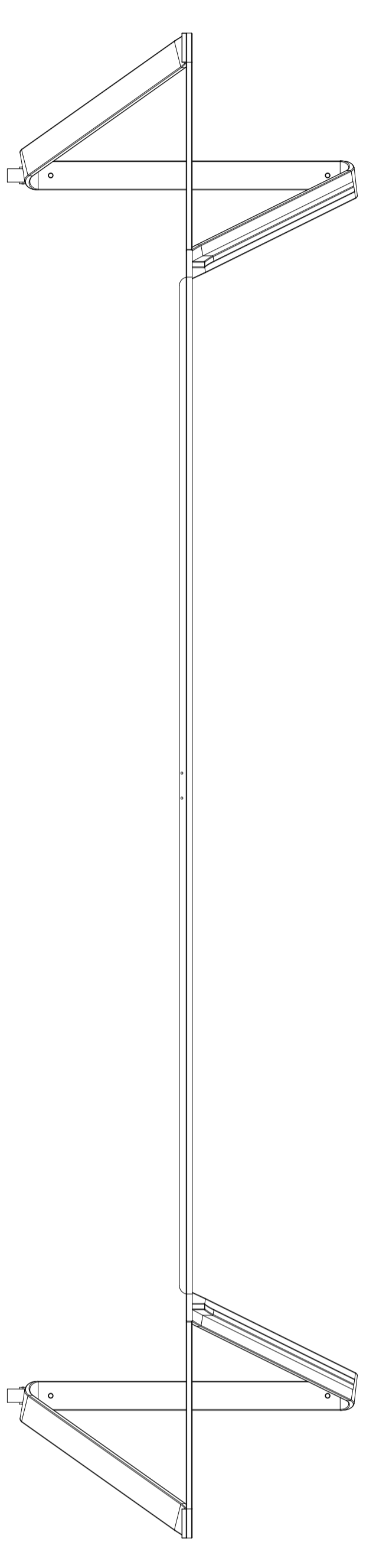
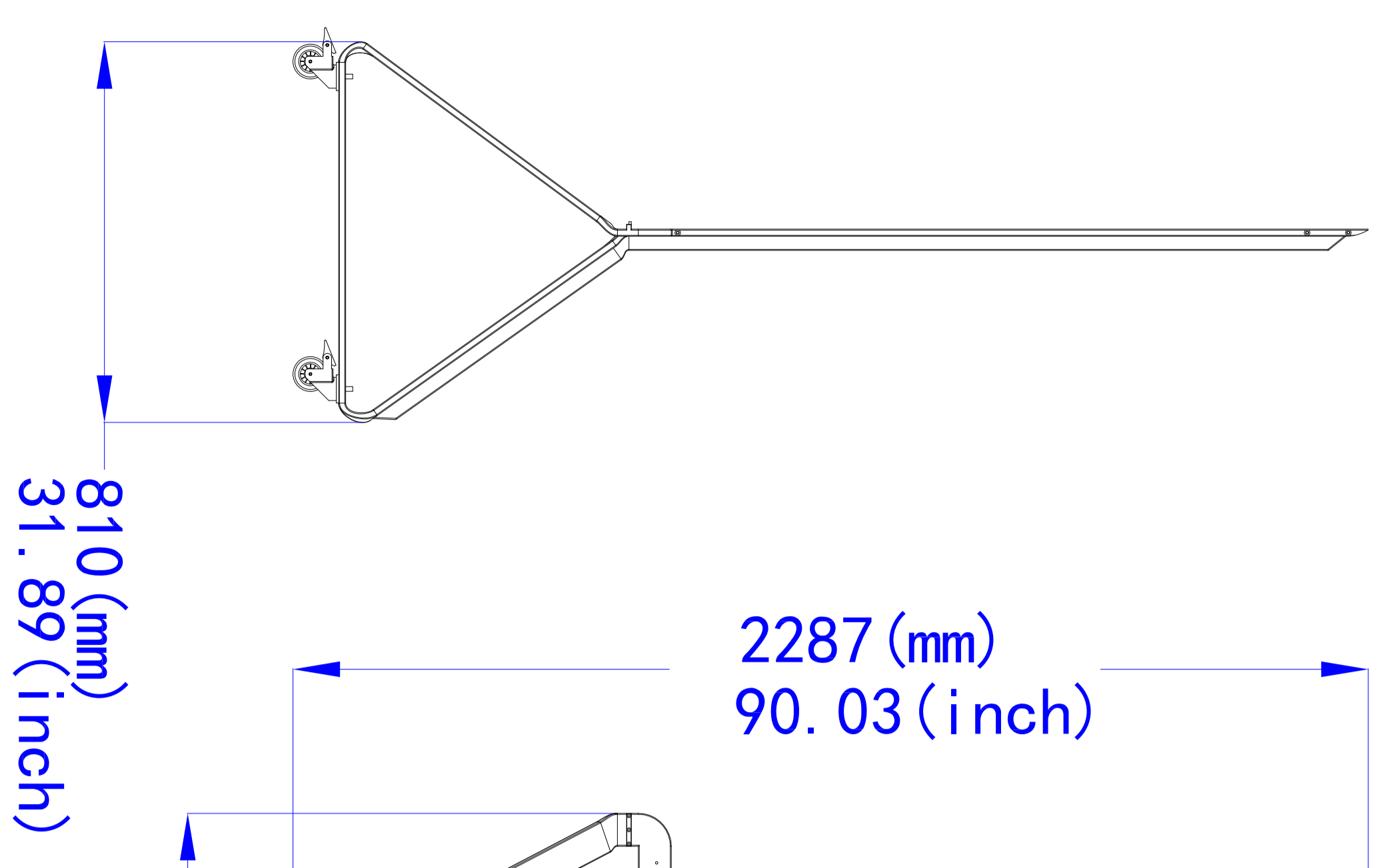
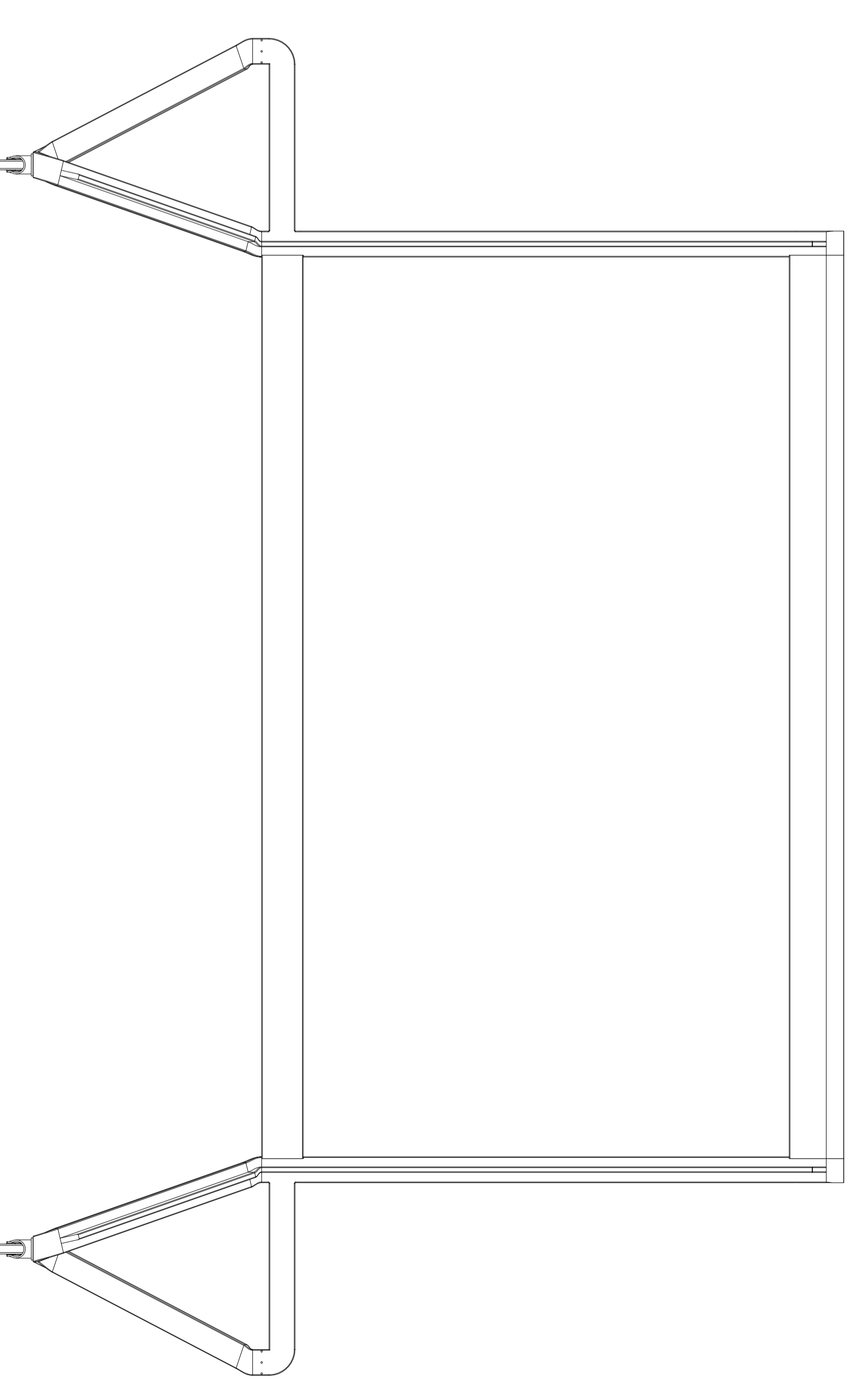
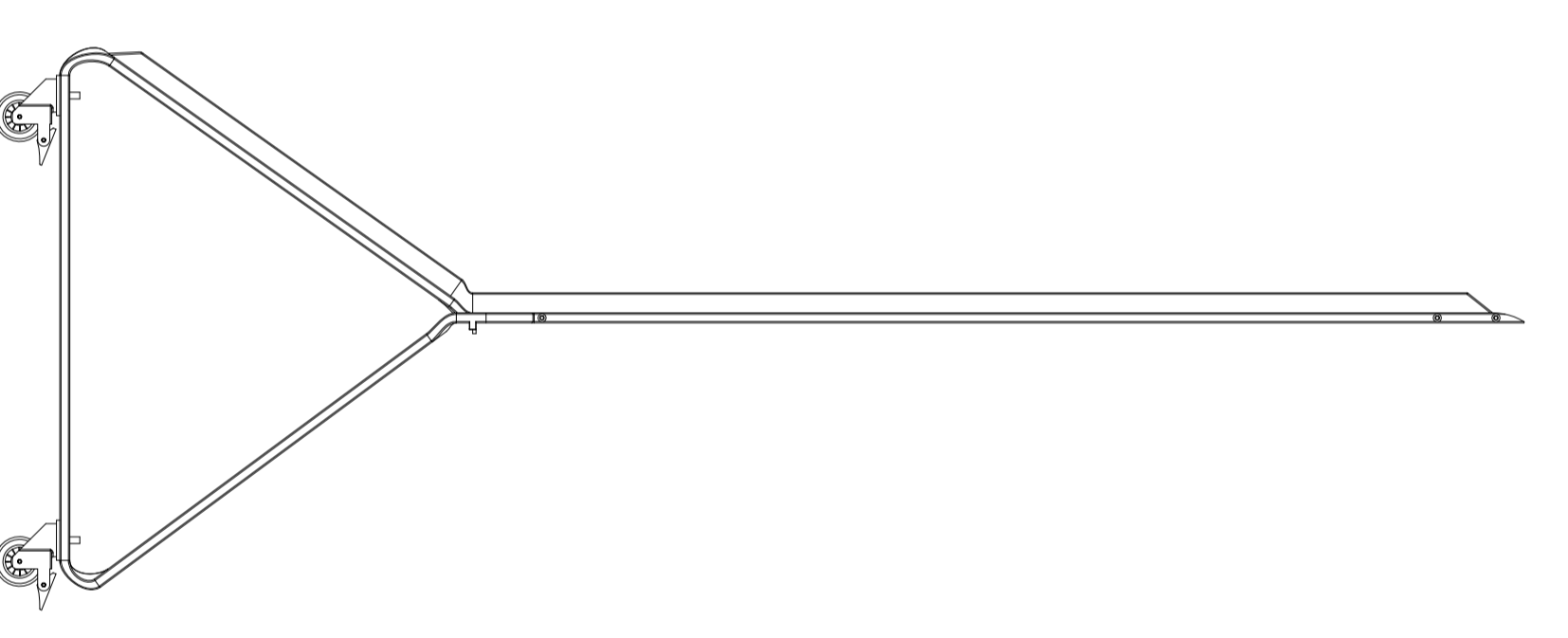
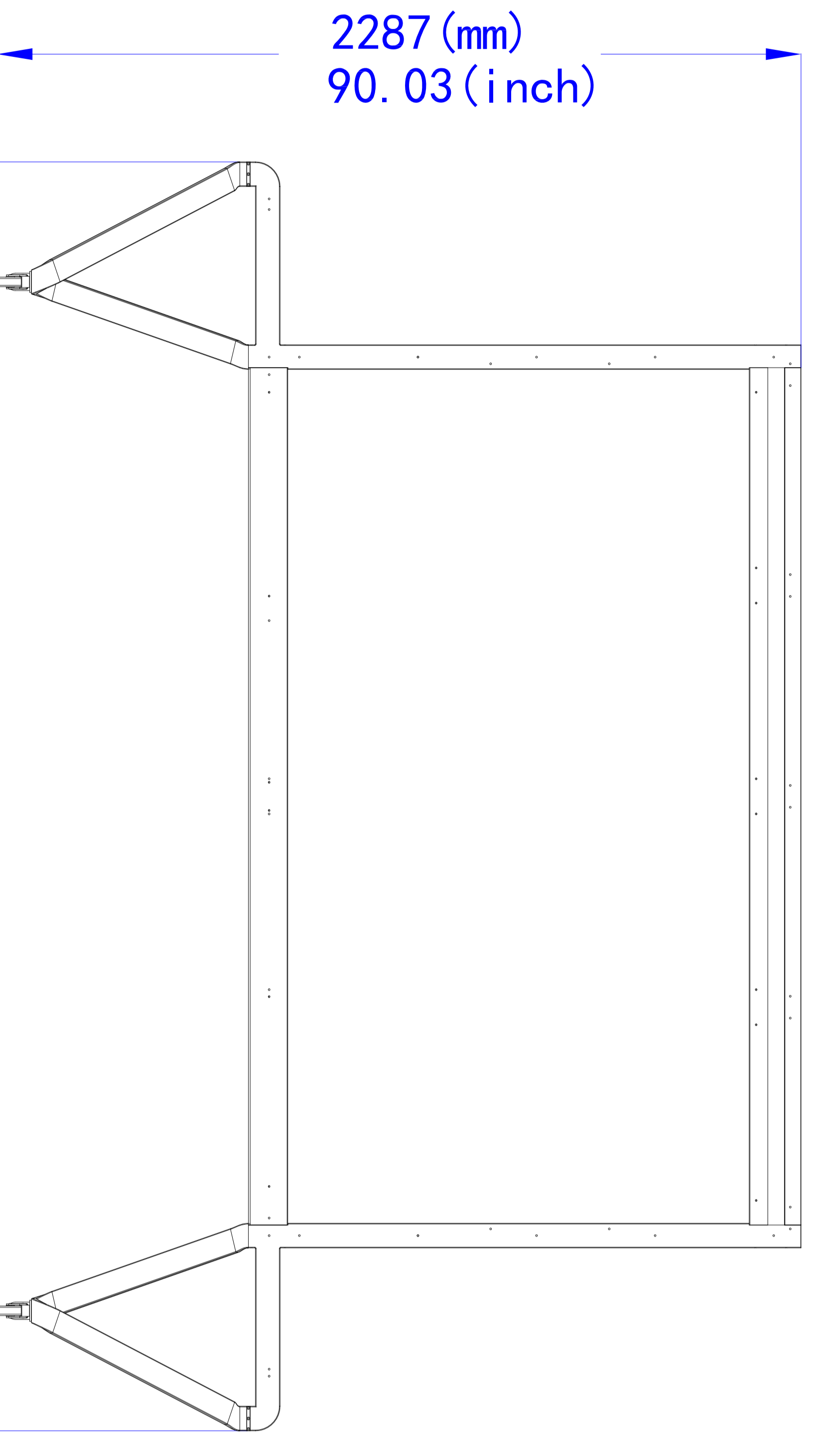
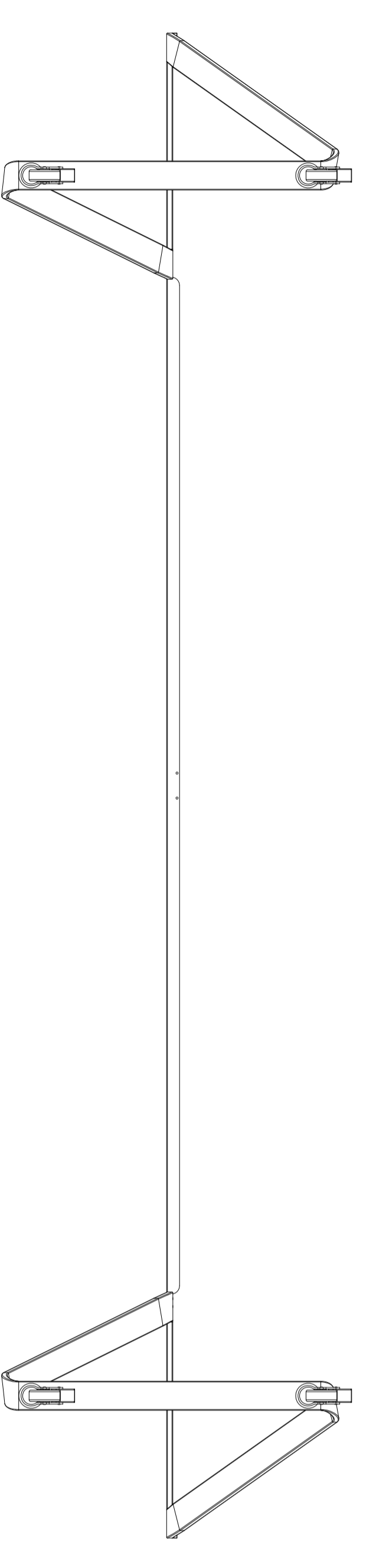

NOTES:

1. ALL undimensioned features refer 3D
2. ALL dimensions without tolerance should follow GB1184-2000.
- 3: surface : Sandblasted black
4. Finish : Ref the artwork
5. MATERIAL : aluminium

MODEL NAME		PART NAME		SCALE		UNIT		mm/inch		STOCK NO.
LD-STND-007 (163")				TOLERANCE UNLESS OTHERWISE SPECIFIED						
DWG	Edison Shen	2023/05/09	MATERIAL	aluminium	0-10	±0.05	200-300	±0.3	---	
DSN			FINISH		10-50	±0.1	300-400	±0.4	---	
CHKD			TEXTURE		50-100	±0.15	400-700	±0.5	SHEET	
APPD					100-200	±0.2	ANGLE	±1.0°	1 OF 1	
				DRAWING NO.		--		Rev.		
				PART NO.				VI.0		

DRAWING NO. _____

1 2 3 4 5 6 7 8 9 10 11 12 13 14 15 16

A B C D E F G H J K