

ViewSonic®



PJD6345/PJD6544w **DLP Projector** **User Guide**

IMPORTANT: Please read this User Guide to obtain important information on installing and using your product in a safe manner, as well as registering your product for future service. Warranty information contained in this User Guide will describe your limited coverage from ViewSonic Corporation, which is also found on our web site at <http://www.viewsonic.com> in English, or in specific languages using the Regional selection box in the upper right corner of our website. "Antes de operar su equipo lea cuidadosamente las instrucciones en este manual"

Model No. VS14971/VS14973

Compliance Information

FCC Statement

This device complies with part 15 of FCC Rules. Operation is subject to the following two conditions: (1) this device may not cause harmful interference, and (2) this device must accept any interference received, including interference that may cause undesired operation.

This equipment has been tested and found to comply with the limits for a Class B digital device, pursuant to part 15 of the FCC Rules. These limits are designed to provide reasonable protection against harmful interference in a residential installation. This equipment generates, uses, and can radiate radio frequency energy, and if not installed and used in accordance with the instructions, may cause harmful interference to radio communications. However, there is no guarantee that interference will not occur in a particular installation. If this equipment does cause harmful interference to radio or television reception, which can be determined by turning the equipment off and on, the user is encouraged to try to correct the interference by one or more of the following measures:

- Reorient or relocate the receiving antenna.
- Increase the separation between the equipment and receiver.
- Connect the equipment into an outlet on a circuit different from that to which the receiver is connected.
- Consult the dealer or an experienced radio/TV technician for help.

Warning: You are cautioned that changes or modifications not expressly approved by the party responsible for compliance could void your authority to operate the equipment.

For Canada

CAN ICES-3 (B)/NMB-3(B)

CE Conformity for European Countries

 The device complies with the EMC Directive 2004/108/EC and Low Voltage Directive 2006/95/EC.

Following information is only for EU-member states:

The mark is in compliance with the Waste Electrical and Electronic Equipment Directive 2002/96/EC (WEEE).

The mark indicates the requirement NOT to dispose the equipment including any spent or discarded batteries or accumulators as unsorted municipal waste, but use the return and collection systems available.

If the batteries, accumulators and button cells included with this equipment, display the chemical symbol Hg, Cd, or Pb, then it means that the battery has a heavy metal content of more than 0.0005% Mercury or more than, 0.002% Cadmium, or more than 0.004% Lead.



Important Safety Instructions

1. Read these instructions.
2. Keep these instructions.
3. Heed all warnings.
4. Follow all instructions.
5. Do not use this unit near water.
6. Clean with a soft, dry cloth.
7. Do not block any ventilation openings. Install the unit in accordance with the manufacturer's instructions.
8. Do not install near any heat sources such as radiators, heat registers, stoves, or other devices (including amplifiers) that produce heat.
9. Do not defeat the safety purpose of the polarized or grounding-type plug. A polarized plug has two blades with one wider than the other. A grounding type plug has two blades and a third grounding prong. The wide blade and the third prong are provided for your safety. If the provided plug does not fit into your outlet, consult an electrician for replacement of the obsolete outlet.
10. Protect the power cord from being walked on or pinched particularly at plugs. Convenience receptacles and the point where they exit from the unit. Be sure that the power outlet is located near the unit so that it is easily accessible.
11. Only use attachments/accessories specified by the manufacturer.
12. Use only with the cart, stand, tripod, bracket, or table specified by the manufacturer, or sold with the unit. When a cart is used, use caution when moving the cart/unit combination to avoid injury from tipping over.
13. Unplug this unit when unused for long periods of time.
14. Refer all servicing to qualified service personnel. Servicing is required when the unit has been damaged in any way, such as: if the power-supply cord or plug is damaged, if liquid is spilled onto or objects fall into the unit, if the unit is exposed to rain or moisture, or if the unit does not operate normally or has been dropped.



Declaration of RoHS2 Compliance

This product has been designed and manufactured in compliance with Directive 2011/65/EU of the European Parliament and the Council on restriction of the use of certain hazardous substances in electrical and electronic equipment (RoHS2 Directive) and is deemed to comply with the maximum concentration values issued by the European Technical Adaptation Committee (TAC) as shown below:

Substance	Proposed Maximum Concentration	Actual Concentration
Lead (Pb)	0.1%	< 0.1%
Mercury (Hg)	0.1%	< 0.1%
Cadmium (Cd)	0.01%	< 0.01%
Hexavalent Chromium (Cr ⁶⁺)	0.1%	< 0.1%
Polybrominated biphenyls (PBB)	0.1%	< 0.1%
Polybrominated diphenyl ethers (PBDE)	0.1%	< 0.1%

Certain components of products as stated above are exempted under the Annex of the RoHS2 Directives as noted below:

Examples of exempted components are:

1. Mercury in compact fluorescent lamps not exceeding 5 mg per lamp and in other lamps not specifically mentioned in the Annex of RoHS2 Directive
2. Lead in glass of cathode ray tubes, electronic components, fluorescent tubes, and electronic ceramic parts (e.g. piezoelectronic devices)
3. Lead in high temperature type solders (i.e. lead-based alloys containing 85% by weight or more lead)

Lead as an alloying element in steel containing up to 0.35% lead by weight, aluminium containing up to 0.4% lead by weight and as a copper alloy containing up to 4% lead by weight

Copyright Information

Copyright © ViewSonic® Corporation, 2013. All rights reserved.
Macintosh and Power Macintosh are registered trademarks of Apple Inc.
Microsoft, Windows, Windows NT, and the Windows logo are registered trademarks of Microsoft Corporation in the United States and other countries.
ViewSonic, the three birds logo, OnView, ViewMatch, and ViewMeter are registered trademarks of ViewSonic Corporation.
VESA is a registered trademark of the Video Electronics Standards Association.
DPMS and DDC are trademarks of VESA.
PS/2, VGA and XGA are registered trademarks of International Business Machines Corporation.
Disclaimer: ViewSonic Corporation shall not be liable for technical or editorial errors or omissions contained herein; nor for incidental or consequential damages resulting from furnishing this material, or the performance or use of this product.
In the interest of continuing product improvement, ViewSonic Corporation reserves the right to change product specifications without notice. Information in this document may change without notice.
No part of this document may be copied, reproduced, or transmitted by any means, for any purpose without prior written permission from ViewSonic Corporation.

Product Registration

To fulfill possible future product needs, and to receive additional product information as it becomes available, please visit your region section on ViewSonic's website to register your product online.
The ViewSonic CD also provides an opportunity for you to print the product registration form. Upon completion, please mail or fax to a respective ViewSonic office. To find your registration form, use the directory “:\CD\Registration”.
Registering your product will best prepare you for future customer service needs. Please print this user guide and fill the information in the “For Your Records” section. Your LCD displays serial number is located on the rear side of the display.
For additional information, please see the “Customer Support” section in this guide.

For Your Records	
Product Name:	PJD6345/PJD6544w ViewSonic DLP Projector
Model Number:	VS14971/VS14973
Document Number:	PJD6345/PJD6544w_UG_ENG Rev. 1B 10-01-13
Serial Number:	_____
Purchase Date:	_____

Product disposal at end of product life

The lamp in this product contains mercury which can be dangerous to you and the environment. Please use care and dispose of in accordance with local, state or federal laws.

ViewSonic respects the environment and is committed to working and living green. Thank you for being part of Smarter, Greener Computing. Please visit ViewSonic website to learn more.

USA & Canada: <http://www.viewsonic.com/company/green/recycle-program/>

Europe: <http://www.viewsoniceurope.com/uk/support/recycling-information/>

Taiwan: <http://recycle.epa.gov.tw/recycle/index2.aspx>

Notes on the AC Power Cord

AC Power Cord must meet the requirement of countries where you use this projector. Please confirm your AC plug type with the graphics below and ensure that the proper AC Power Cord is used. If the supplied AC Power Cord does not match your AC outlet, please contact your sales dealer. This projector is equipped with a grounding type AC line plug. Please ensure that your outlet fits the plug. Do not defeat the safety purpose of this grounding type plug. We highly recommend using a video source device also equipped with a grounding type AC line plug to prevent signal interference due to voltage fluctuations.

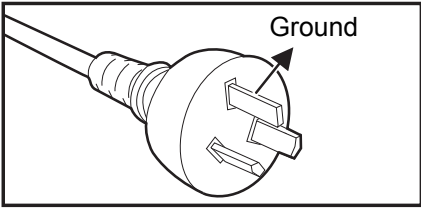

For Australia and Mainland China

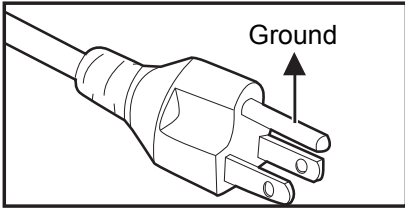

For the U.S.A. and Canada

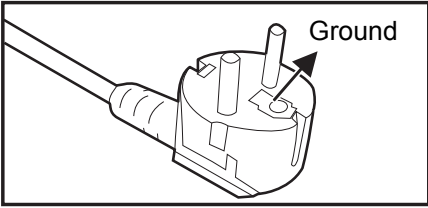

For Continental Europe

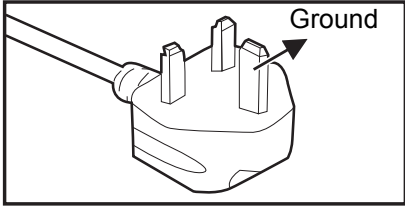

For the U.K.

Table of contents

Introduction	1
Projector Features	1
Package Contents	2
Projector Overview	3
Using the Product	5
Control Panel	5
Connection Ports	6
Remote Control	8
Installing the Batteries	11
Remote Control Operation	12
Connection	13
Connecting a computer or monitor	14
Connecting Video source devices	16
Playing sound through the projector	18
Operation	20
Powering On/Off the Projector	20
Adjusting the Projector Height	21
Adjusting the Projector Zoom and Focus	21
Adjusting Projection Image Size	22
Locking control keys	24
Setting the presentation timer	25
Menu operation	26
Controlling the projector through a LAN environment	38
Controlling the projector through a web browser	41
Displaying images through vsPresenter	46
Displaying pictures with a USB storage device	49
Maintenance	61
Cleaning the Lens	61
Cleaning the Projector Housing	61
Replacing the Lamp	62
Specifications	64
Dimensions	65
Ceiling mount installation	65
Appendix	66
LED Indicator Messages	66
Compatibility Modes	67
Troubleshooting	68
RS-232 Command and Configuration	69
IR Control Code	72

Introduction

Projector Features

The projector integrates high-performance optical engine projection and a user - friendly design to deliver high reliability and ease of use.

The projector offers the following features:

- Single chip 0.55" Texas Instruments DLP® technology
- PJD6345: XGA (1024x768 pixel)
- Single chip 0.65" Texas Instruments DLP® technology
- PJD6544w: WXGA (1280x800 pixel)
- Compatibility with Macintosh® computers
- Compatibility with NTSC, PAL, SECAM and HDTV
- D-Sub 15-pin terminal for analog video connectivity
- User-friendly, multi-language on-screen display
- Advanced electronic keystone correction
- RS-232 connector for serial control
- HDMI 1.4a support
- PJLink™ compatible
- Support remote control with Crestron software
- LAN display 4-1 (maximum 4 PC/ NB / smart phone / smart Pad display to 1 projector)
- USB display supports computer connection via USB mini-B type to A type cable
- Support USB flash drive for Photo / Video / music playback and office viewer function
- DynamicEco Timer function decreasing the power consumption of the lamp by up to 70% when no input signal can be detected for a set period of time.
- Selectable quick power off function
- Switchable normal and economic modes to reduce the power consumption
- Support 3D DLP link technology
- Less then 0.5w power consumption in standby mode.

Note

- *The information in this manual is subject to change without notices.*
- *The reproduction, transfer or copy of all or any part of this document is not permitted without express written consent.*
- *The apparent brightness of the projected image will vary depending on the ambient lighting conditions, selected input signal contrast/brightness settings, and is directly proportional to projection distance.*
- *The lamp brightness will decline over time and may vary within the lamp manufacturers specifications. This is normal and expected behavior.*

Package Contents

When you unpack the projector, make sure you have all these components:

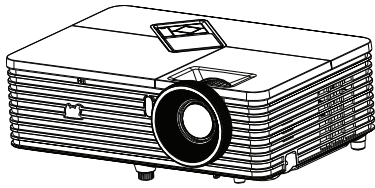

Projector

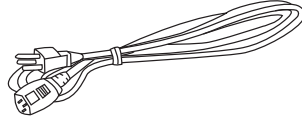

AC Power Cord

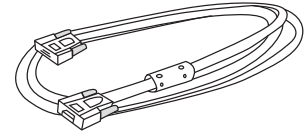

VGA cable (D-SUB to D-SUB)



Remote Control (IR) & batteries (AAA *2 PCS)

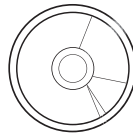

ViewSonic CD Wizard

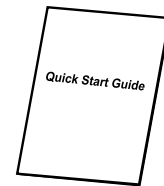

Quick Start Guide

Optional accessories

1. Ceiling mount kit
2. Replacement Lamp
3. VGA - Components adapter

Note

- **Contact your dealer immediately if any items are missing, appear damaged, or if the unit does not work.**
- **For maximum protection of the product, please save the original shipping carton and packing materials and repack your product as it was originally packed at the factory if you need to ship it.**

Projector Overview

Front View

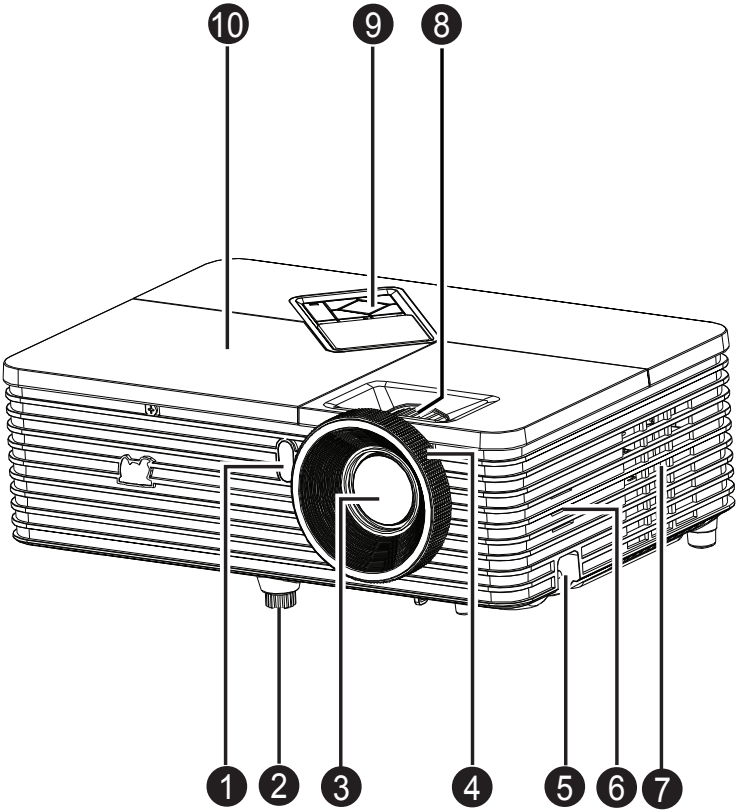

- 1. Front IR remote control sensor
- 2. Elevator foot
- 3. Projection lens
- 4. Focus ring
- 5. Security bar
- 6. Speaker
- 7. Ventilation holes
- 8. Zoom ring
- 9. Control panel
- 10. Lamp cover

Rear View

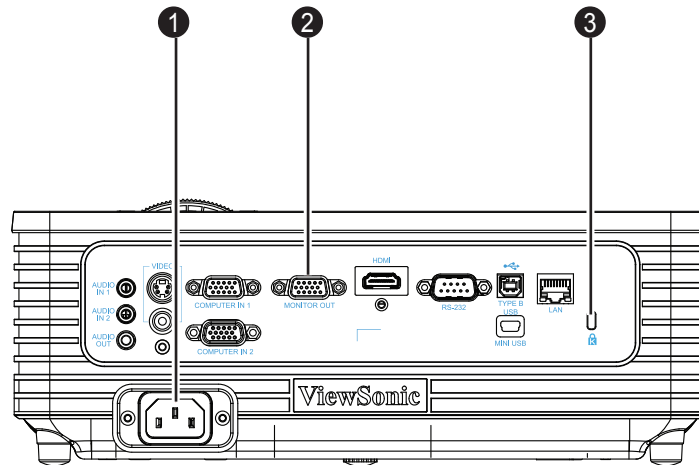

1. AC power socket
3. Kensington lock

2. Connection ports

Bottom View

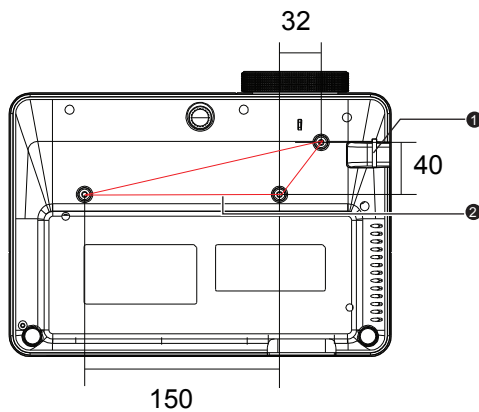

1. Security bar

2. Ceiling mount holes

Ceiling mount screws:
M4 x 8 (Max. L = 8 mm)

Unit: mm

Note

- ***This projector can be used with a ceiling mount for support. The ceiling mount is not included in the package.***
- ***Contact your dealer for information to mount the projector on a ceiling.***
- ***When installing the unit, incorporate a readily accessible disconnect device in the fixed wiring, or connect the power plug to an easily accessible socket-outlet near the unit. If a fault should occur during operation of the unit, operate the disconnect device to switch the power supply off, or disconnect the power plug.***

Using the Product

Control Panel

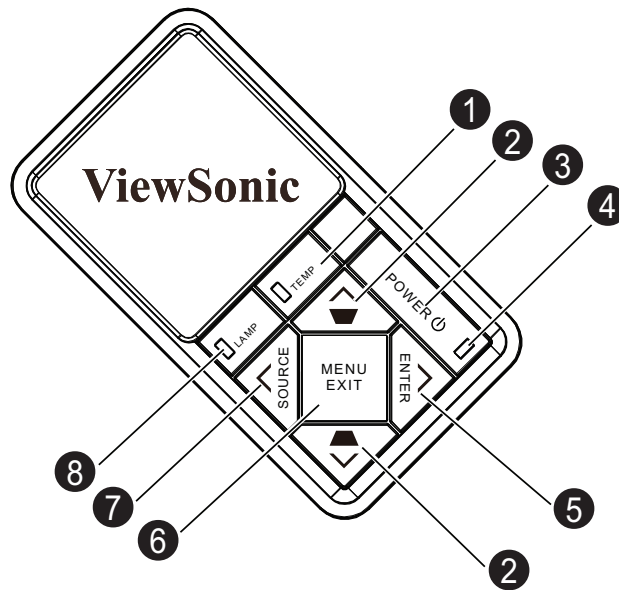

- 1. TEMP (Temp LED indicator)**
Refer to “LED Indicator Messages”.
- 2. Keystone/Arrow keys (▲/Up, ▼/Down)**
Manually correct distorted images resulting from an angled projection.
- 3. POWER**
Turn the projector on or off.
- 4. POWER (Power LED indicator)**
Refer to “LED Indicator Messages”.
- 5. ENTER/Arrow key (▶/Right)**
Enacts the selected On-Screen Display (OSD) menu item.

When the On-Screen Display (OSD) menu is activated, #2 #5 and #7 keys are used as directional arrows to select the desired menu items and to make adjustments.
- 6. MENU/EXIT**
Display or exit the on-screen display menus.
- 7. SOURCE/Arrow key (◀/Left)**
Display the source selection bar.
- 8. LAMP (Lamp LED indicator)**
Refer to “LED Indicator Messages”.

Connection Ports

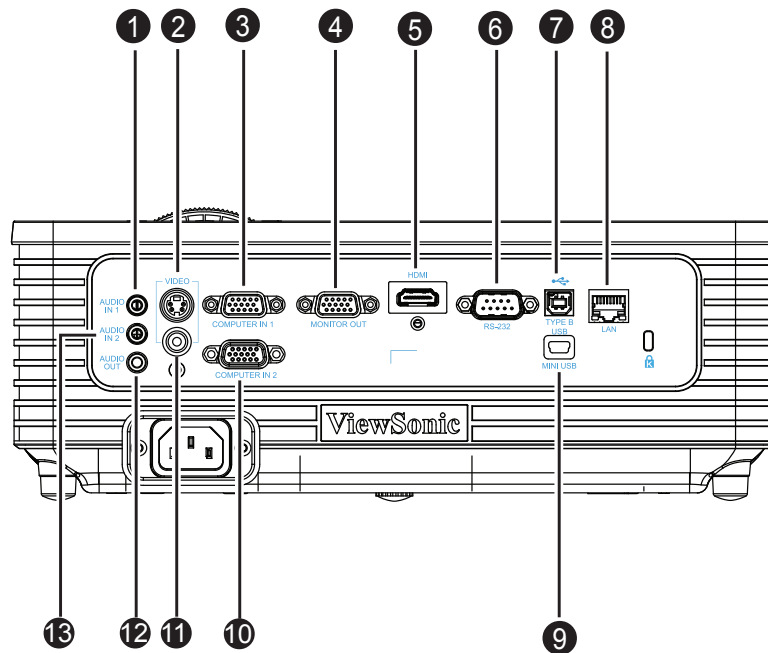

- 1. AUDIO IN 1**
Connect an audio output from the Computer In1 to this jack.
- 2. S-VIDEO**
Connect S-Video output from video equipment to this jack.
- 3. COMPUTER IN 1**
Connect image input signal (analog RGB or component) to this jack.
- 4. COMPUTER OUT**
Connect to a computer display, etc.
- 5. HDMI**
Connect HDMI output from video equipment to this jack.
- 6. RS-232**
When operating the projector via a computer, connect this to the controlling computer's RS-232C port.
- 7. TYPE B USB**
This connector is for firmware update and mouse function support.
- 8. LAN**
RJ45 connector for Ethernet connection.
- 9. MINI USB**
USB display supports computer connection via USB mini-B type to A type cable.
- 10. COMPUTER IN 2**
Connect image input signal (analog RGB or component) to this jack.

11. VIDEO

Connect composite video output from video equipment to this jack.

12. AUDIO OUT

Connect to a speaker or other audio input equipment.

13. AUDIO IN 2

Connect an audio output from the Computer In2 or video to this jack.

Remote Control

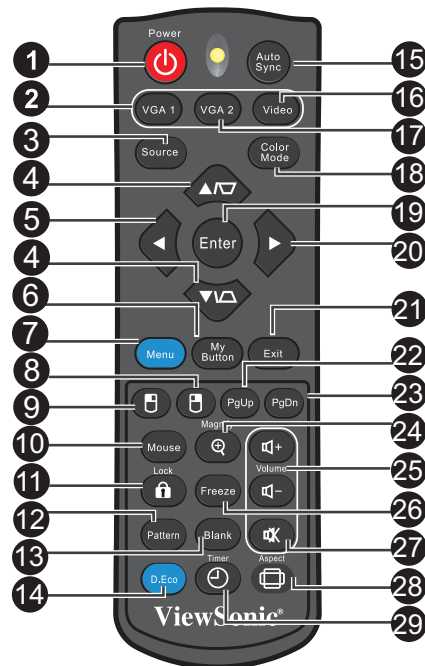

1. **Power**
Turn the projector on or off.
2. **VGA1**
Display COMPUTER IN 1 signal.
3. **Source**
Display the source selection bar.
4. **Keystone/Arrow keys (▲/Up, ▼/Down)**
Manually correct distorted images resulting from an angled projection.
5. **◀Left**
When the On-Screen Display (OSD) menu is activated, the #4, #5, and #20 keys are used as directional arrows to select the desired menu items and to make adjustments.
6. **My Button**
User definable key for customized function
7. **Menu**
Display on-screen display menus.
8. **Right mouse**
Perform the right button of the mouse when mouse mode is activated.
9. **Left mouse**
Perform the left button of the mouse when mouse mode is activated.
10. **Mouse**
Switch between the normal and mouse modes.
11. **Lock**
Activate panel key lock.

12. Pattern

Display embedded test pattern.

13. Blank

Hide the screen picture.

14. D.Eco

Decreases the power consumption of the lamp by up to 70%.

Note: It takes some time to initiate this function. Make sure the projector has been turned on for more than 4 minutes.

15. Auto Sync

Automatically determines the best picture timings for the displayed image.

Note: Switch input source to Composite/S-Video/HDMI by sequence.

HMI only for PJD5234

16. Video

Switch input source to Composite/S-Video/HDMI by sequence.

17. VGA2

Display COMPUTER IN 2 signal.

18. Color Mode

Select the picture setup mode.

19. Enter

Confirmed selections.

20. ► Right

When the On-Screen Display (OSD) menu is activated, the #4, #5, and #20 keys are used as directional arrows to select the desired menu items and to make adjustments.

21. Exit

Goes back to previous OSD menu.

22. Page Up

Perform page up function when mouse mode is activated.

23. Page Down

Perform page down function when mouse mode is activated.

24. Magnify

Magnifies the projected picture size.

25. Volume

Adjust the volume level.

26. Freeze

Freeze the projected image.

27. Mute

Toggles the projector audio between on and off.

28. Aspect

Select the display aspect ratio.

29. Timer

Activate P-Timer OSD menu.

Using the remote mouse control

The capability of operating your computer with the remote control gives you more flexibility when delivering presentations.

1. Connect the projector to your PC or notebook with a USB cable prior to using the remote control in place of your computer's mouse. See "[Connecting a computer](#)" on page 14 for details.
2. Set the input signal to **COMPUTER IN 1** or **COMPUTER IN 2**.
3. Press **Mouse** on the remote control to switch from the normal mode to the mouse mode. An icon appears on the screen to indicate the activation of the mouse mode.
4. Perform the desired mouse controls on your remote control.
 - To move the cursor on the screen, press ▲/▼/◀/▶ .
 - To left-click, press ⏏ .
 - To right-click, press ⏏ .
 - To operate your display software program (on a connected PC) which responds to page up/down commands (like Microsoft PowerPoint), press **Page Up/Page Down**.
 - To return to the normal mode, press **Mouse** again.

Installing the Batteries

1. Open the battery cover in the direction shown.

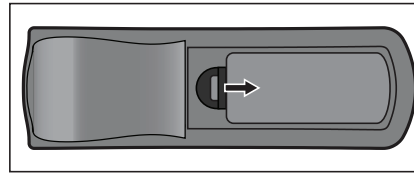

2. Install batteries as indicated by the diagram inside the compartment.

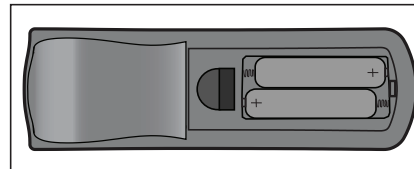

3. Close the battery cover into position.

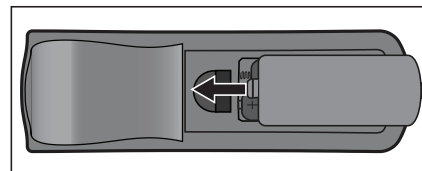

Caution

- **Risk of explosion if battery is replaced by an incorrect type.**
- **Dispose of used batteries according to the instructions.**
- **Make sure the plus and minus terminals are correctly aligned when loading a battery.**

Note

- **Keep the batteries out of the reach of children. There is a danger of death by accidentally swallowing the batteries.**
- **Remove batteries from remote control when not using for extended periods.**
- **Do not dispose of the used batteries along with household waste. Dispose of used batteries according to local regulations.**
- **Danger of explosion may happen if batteries are incorrectly replaced. Replace all the batteries with new ones.**
- **Batteries should not be in or near to fire or water, keep batteries in a dark, cool and dry place.**
- **If suspect battery leakage, wipe out the leakage and then replace new batteries.**
- **If the leakage adheres to your body or clothes, rinse well with water immediately.**

Remote Control Operation

Point the remote control at the infrared remote sensor and press a button.

- Operating the projector from the front

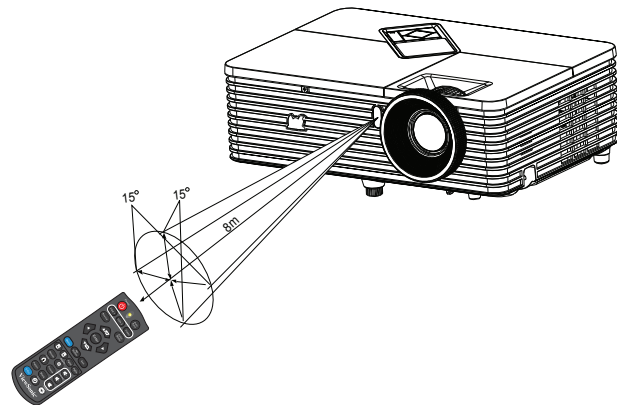

Note

- ***Do not point the laser directly to the people's eyes (especially small children). There is a danger of injury to the eyes.***
- ***The remote control may not operate when there is sunlight or other strong light such as a fluorescent lamp shining on the remote sensor.***
- ***Operate the remote control from a position where the remote sensor is visible.***
- ***Do not drop the remote control or jolt it.***
- ***Keep the remote control out of locations with excessively high temperature or humidity.***
- ***Do not get water on the remote control or place wet objects on it.***
- ***Do not disassemble the remote control.***

Connection

When connecting a signal source to the projector, be sure to:

1. Turn all equipment off before making any connections.
2. Use the correct signal cables for each source.
3. Ensure the cables are firmly inserted.

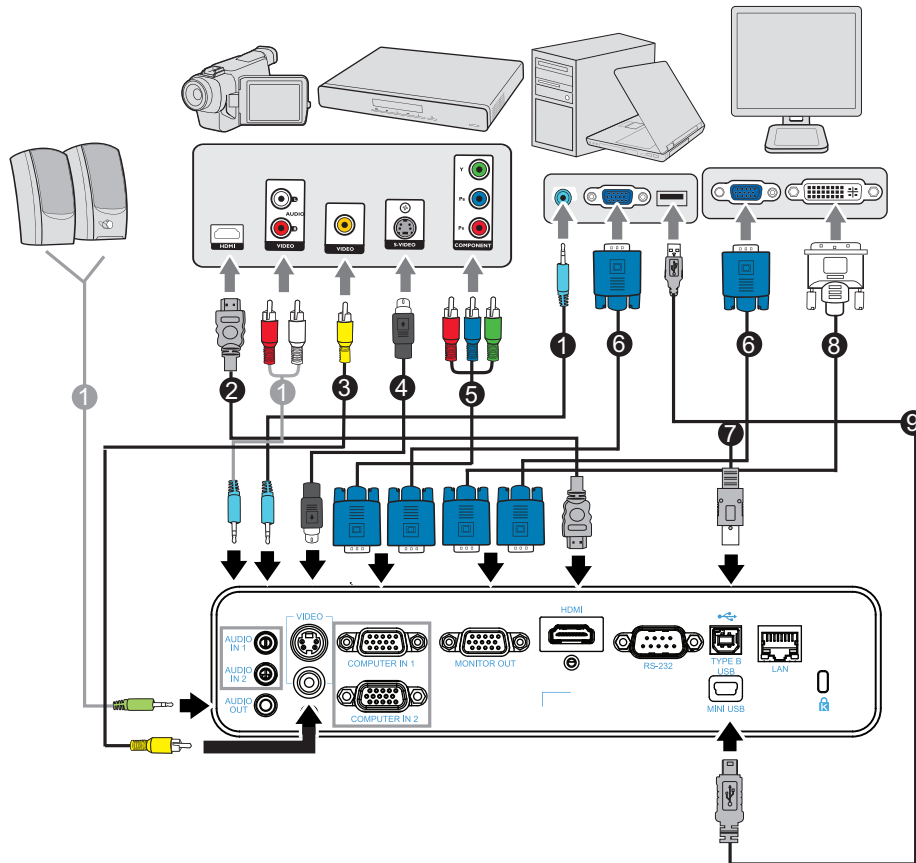

- | | |
|--------------------------------------|-------------------------------|
| 1. Audio cable | 2. HDMI cable |
| 3. Composite Video cable | 4. S-Video cable |
| 5. VGA (D-Sub) to HDTV (RCA) cable | 6. VGA cable (D-Sub to D-Sub) |
| 7. USB cable (B type to A type) | 8. VGA to DVI-A cable |
| 9. USB cable (mini-B type to A type) | |

Important

- ***In the connections shown above, some cables may not be included with the projector (see "Package Contents" on page 2). They are commercially available from electronics stores.***
- ***The connection illustrations above are for reference only. The rear connecting jacks available on the projector vary with each projector model.***
- ***For detailed connection methods, see pages 14-18.***

Connecting a computer or monitor

Connecting a computer

The projector provides two VGA input sockets that allow you to connect them to both IBM® compatibles and Macintosh® computers. A Mac adapter is needed if you are connecting legacy version Macintosh computers.

To connect the projector to a notebook or desktop computer:

- Using a VGA cable
 1. Take the supplied VGA cable and connect one end to the D-Sub output socket of the computer.
 2. Connect the other end of the VGA cable to the **COMPUTER IN 1** or **COMPUTER IN 2** signal input socket on the projector.
 3. If you wish to use the remote paging function, take a USB cable and connect the A type end to the USB port of the computer, and the other end to the **TYPE B USB** socket on the projector. See ["Using the remote mouse control"](#) on page 10 for details.

Important

- *Many notebooks do not turn on their external video ports when connected to a projector. Usually a key combo like FN + F3 or CRT/LCD key turns the external display on/off. Locate a function key labeled CRT/LCD or a function key with a monitor symbol on the notebook. Press FN and the labeled function key simultaneously. Refer to your notebook's documentation to find your notebook's key combination.*
- Using a USB cable
 1. Take a USB cable and connect the type A end to the USB output jack of the computer.
 2. Connect the mini-B type end of the USB cable to the mini-B USB jack on the projector.

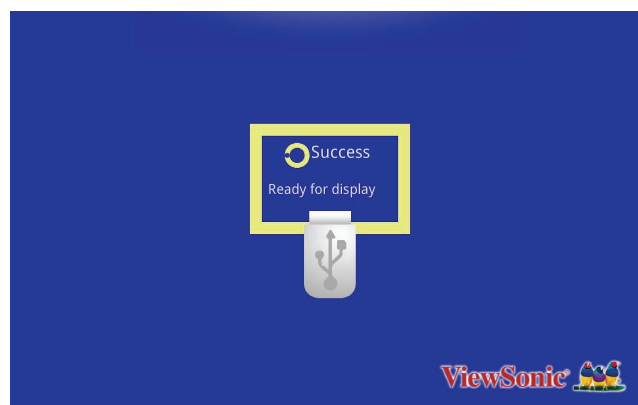

3. Go to "My Computer", find a disk drive, then double click it to to install the USB driver.

4. Double click “ViewSonic USB Mirror-only” icon on the desktop, and the ViewSonic USB displays on the screen.

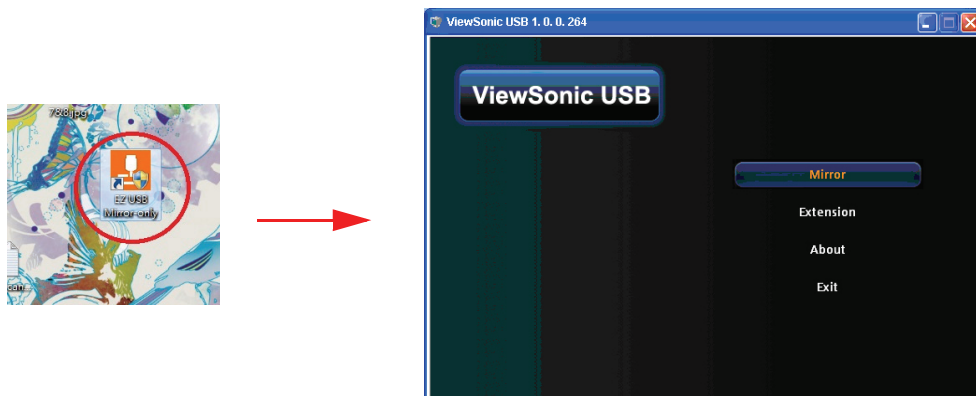

5. Select Mirror or Extension to display your contents.



Important

- *ViewSonic USB function can't support Mac OS devices.*

Connecting a monitor

If you want to view your presentation close-up on a monitor as well as on the screen, you can connect the **MONITOR OUT** signal output socket on the projector to an external monitor with a VGA cable following the instructions below:

To connect the projector to a monitor:

1. Connect the projector to a computer as described in "[Connecting a computer](#)" on [page 14](#).
2. Take a suitable VGA cable (only one supplied) and connect one end of the cable to the D-Sub input socket of the video monitor.

Or if your monitor is equipped with a DVI input socket, take a VGA to DVI-A cable and connect the DVI end of the cable to the DVI input socket of the video monitor.

3. Connect the other end of the cable to the **MONITOR OUT** socket on the projector.

Important



- *In standby mode, the COMPUTER OUT output only works when COMPUTER IN 1 is made to the projector.*

Connecting Video source devices

You can connect your projector to various Video source devices that provide any one of the following output sockets:

- HDMI
- Component Video
- S-Video
- Video (composite)

You need only connect the projector to a Video source device using just one of the above connecting methods, however each provides a different level of video quality. The method you choose will most likely depend upon the availability of matching terminals on both the projector and the Video source device as described below:

Terminal name	Terminal appearance	Reference	Picture quality
HDMI	HDMI 	"Connecting an HDMI source device" on page 16	Best
S-Video	S-VIDEO 	"Connecting an S-Video source device" on page 17	Good
Video	VIDEO 	"Connecting a composite Video source device" on page 18	Normal

Connecting an HDMI source device

Examine your Video source device to determine if it has a set of unused HDMI output jacks available:

- If so, you can continue with this procedure.
- If not, you will need to reassess which method you can use to connect to the device.

To connect the projector to an HDMI source device:

1. Take an HDMI cable and connect one end to the HDMI output jack of the HDMI source device.
2. Connect the other end of the HDMI cable to the HDMI jack on the projector.

Connecting a Component Video source device

Examine your Video source device to determine if it has a set of unused Component Video output sockets available:

- If so, you can continue with this procedure.
- If not, you will need to reassess which method you can use to connect to the device.

To connect the projector to a Component Video source device:

1. Take a VGA (D-Sub) to HDTV (RCA) cable and connect the end with 3 RCA type connectors to the Component Video output sockets of the Video source device. Match the color of the plugs to the color of the sockets; green to green, blue to blue, and red to red.
2. Connect the other end of the cable (with a D-Sub type connector) to the **COMPUTER IN 1** or **COMPUTER IN 2** socket on the projector.

Important

- *If the selected video image is not displayed after the projector is turned on and the correct video source has been selected, check that the Video source device is turned on and operating correctly. Also check that the signal cables have been connected correctly.*
-  **VGA component adapter (ViewSonic P/N: CB-00008906)**

Connecting an S-Video source device

Examine your Video source device to determine if it has an unused S-Video output socket available:

- If so, you can continue with this procedure.
- If not, you will need to reassess which method you can use to connect to the device.

To connect the projector to an S-Video source device:

1. Take an S-Video cable and connect one end to the S-Video output socket of the Video source device.
2. Connect the other end of the S-Video cable to the **S-VIDEO** socket on the projector.

Important

- *If the selected video image is not displayed after the projector is turned on and the correct video source has been selected, check that the Video source device is turned on and operating correctly. Also check that the signal cables have been connected correctly.*
- *If you have already made a Component Video connection between the projector and this S-Video source device using Component Video connections, you need not connect to this device using an S-Video connection as this makes an unnecessary second connection of poorer picture quality. See ["Connecting Video source devices"](#) on page 16 for details.*

Connecting a composite Video source device

Examine your Video source device to determine if it has a set of unused composite Video output sockets available:

- If so, you can continue with this procedure.
- If not, you will need to reassess which method you can use to connect to the device.

To connect the projector to a composite Video source device:

1. Take a Video cable and connect one end to the composite Video output socket of the Video source device.
2. Connect the other end of the Video cable to the **VIDEO** socket on the projector.

Important

- *If the selected video image is not displayed after the projector is turned on and the correct video source has been selected, check that the Video source device is turned on and operating correctly. Also check that the signal cables have been connected correctly.*
- *You need only connect to this device using a composite Video connection if Component Video and S-Video inputs are unavailable for use. See "[Connecting Video source devices](#)" on page 16 for details.*

Playing sound through the projector

You can make use of the projector (mixed mono) speaker in your presentations, and also connect separate amplified speakers to the **AUDIO OUT** socket of the projector. If you have a separate sound system, you will most likely want to connect the audio output of your Video source device to that sound system, instead of to the mono audio projector.

You can also use a microphone to output the sound through the projector speaker. Once connected, the audio can be controlled by the projector On-Screen Display (OSD) menus. See "[Audio Setting](#)" on page 33 for details.

The table below describes the connection methods for different devices, and where the sound is from.

Projector IO	Audio in 1	Audio in 2	Microphone
Audio in 2 setting	Audio in 2 → Audio in	Audio in 2 → Microphone	
Audio in 1	Computer in 1	Computer in 1 Computer in 2 Composite S-video	NA
Audio in 2	Computer in 2 Composite S-video	NA	Computer in 1 Computer in 2 Composite S-video

The selected input signal determines which sound will be played by the projector speaker, and which sound will be output from the projector when AUDIO OUT is connected. If you select a PC signal; the projector can play the sound received from AUDIO IN 1/ AUDIO IN 2 or MIC.

About the microphone input

- If you wish to use a microphone, connect a 3.5 mini jack cable microphone to the projector.
- You can use a wireless microphone as long as a wireless module is attached to the projector's microphone input jack and it works well with the associated devices.
- To ensure a quality use of the wireless microphone, it is recommended that your microphone conforms to the specifications listed in the table below.

Signal	Parameter	Min	Type	Max	
Microphone	Transducer Principle				Dynamic
	Impedance	300		1K	ohm
	Frequency response	600		16K	Hz

- There are two ways to adjust microphone volumes.
 - Directly set microphone volume levels in the **Video/Audio > Audio Setting > Microphone Volume** menu.
 - Set projector volume levels in the **Video/Audio > Audio Setting > Volume** menu, or press Volume keys (+, -) on the remote control. (The projector volume setting will affect the microphone volume.)
- To make the microphone input available when the projector is in standby mode, turn on the **Video/Audio > Audio Setting > Active Audio Out** menu.
- If the microphone is not working, check the volume setting and cable connection.
- You might get feedback noise from the microphone when you are too close to the speaker of the projector. Move the microphone away from the speaker of the projector. The greater volume you require, the greater distance you need to be away from the Speaker to prevent the noise.

Operation

Powering On/Off the Projector

Powering On the Projector:



1. Complete the AC power cord and peripheral signal cable(s) connections.
2. Press  to turn on the projector.
The projector takes a minute or so to warm up.
3. Turn on your source (computer, notebook, DVD, etc.). The projector automatically detects your source when Auto source setting is ON.
 - If you are connecting multiple sources to the projector simultaneously, press **SOURCE** on the projector to select your desired signal or press your desired signal key on the remote control.
 - If the projector doesn't detect a valid signal, the message 'No Signal' will continue to be displayed.
 - Be sure the Quick Auto Search function in the SOURCE menu is On if you want the projector to automatically search for the signals.



Warning

- *Remove the lens cap first before powering on.*
- *Never look into the lens when the lamp is on. This can damage your eyes.*
- *This focal point concentrates high temperature. Do not place any object near it to avoid possible fire hazard.*

Powering Off the Projector:

1. Press  to turn off the projector lamp. You will see a message "Power off? Press Power again" appear on the screen.
2. Press  again to confirm.
 - When green mode is turned off, the Power LED begins flashing and the projector has entered stand-by mode.
 - When green mode is turned on, the Power LED becomes steady light and the projector has entered stand-by mode.
 - If you want to turn the projector back on, you must wait until the projector has completed the cooling cycle and has entered stand-by mode. Once in stand-by mode, simply press  to restart the projector.
3. Disconnect the AC power cord from the electrical outlet and the projector.
4. Do not turn on the projector right after power off.

Adjusting the Projector Height

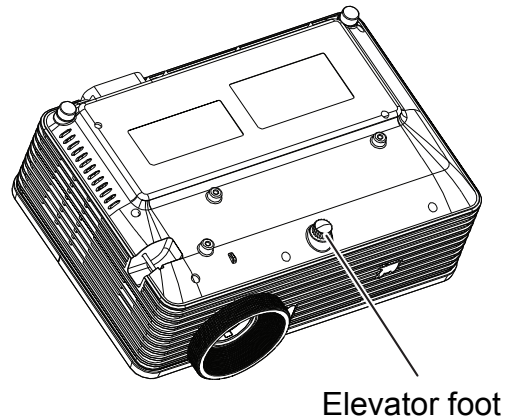

The projector is equipped with an elevator foot to adjust the image height. To raise or lower the image, turn the elevator foot to fine-tune the height.

Note

- *To avoid damaging the projector, make sure that the elevator foot and tiltadjustment feet are fully retracted before placing the projector in its carrying case.*

Adjusting the Projector Zoom and Focus

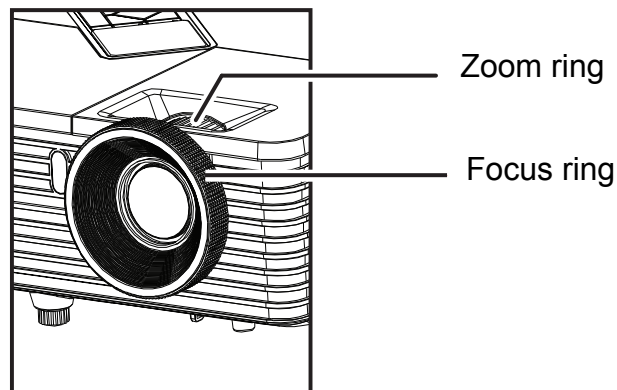

1. Focus the image by rotating the focus ring. A still image is recommended for focusing.
2. Adjust the image size by sliding the zoom ring.

Adjusting Projection Image Size

Refer to the graphic and table below to determine the screen size and projection distance.

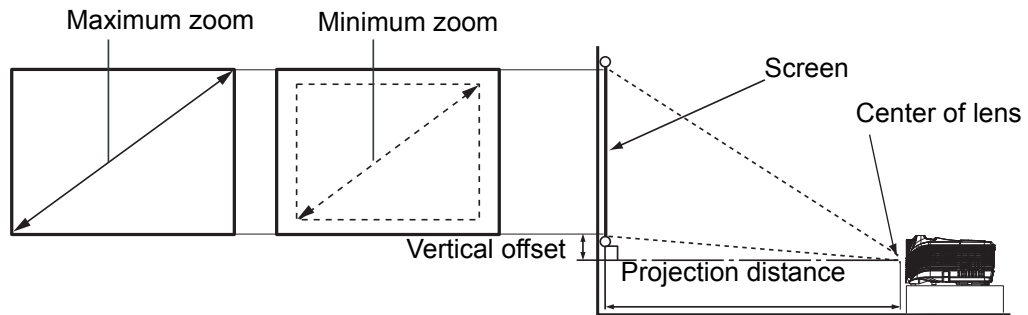

PJD6345

Screen size Diagonal [inch (cm)]	4 : 3 Screen			
	Projection distance [inch (m)]		Image height [inch (cm)]	Vertical offset [inch (cm)]
	(min. zoom)	(max. zoom)		
40 (102)	62 (1.6)	69 (1.7)	24 (60.96)	3.6 (9.1)
60 (152)	94 (2.4)	103 (2.6)	36 (91.44)	5.4 (13.7)
80 (203)	125 (3.2)	137 (3.5)	48 (121.92)	7.2 (18.2)
100 (254)	156 (4.0)	172 (4.4)	60 (152.4)	9.0 (22.9)
150 (381)	234 (5.9)	257 (6.5)	90 (228.6)	13.5 (34.3)
200 (508)	312 (7.9)	343 (8.7)	120 (304.8)	18.0 (45.7)
250 (635)	390 (9.9)	429 (10.9)	150 (381.0)	22.5 (57.2)
300 (762)	468 (11.9)	515 (13.1)	180 (457.2)	27.0 (68.6)

PJD6544w

Screen size Diagonal [inch (cm)]	16 : 10 Screen			
	Projection distance [inch (m)]		Image height [inch (cm)]	Vertical offset [inch (cm)]
	(min. zoom)	(max. zoom)		
40 (102)	51 (1.3)	61 (1.5)	21 (54)	2.6 (6.7)
60 (152)	76 (1.9)	91 (2.3)	32 (81)	4.0 (10.1)
80 (203)	101 (2.6)	121 (3.1)	42 (108)	5.3 (13.5)
100 (254)	126 (3.2)	152 (3.9)	53 (135)	6.6 (16.8)
150 (381)	190 (4.8)	228 (5.8)	79 (202)	9.9 (25.2)
200 (508)	253 (6.4)	304 (7.7)	106 (269)	13.2 (33.7)
250 (635)	316 (8.0)	379 (9.6)	132 (337)	16.6 (42.1)
300 (762)	379 (9.6)	455 (11.6)	159 (404)	19.9 (50.5)

Note

- **Position the projector in a horizontal position; other positions can cause heat build-up and damage to the projector.**
- **Keep a space of 30 cm or more between the sides of the projector.**
- **Do not use the projector in a smoky environment. Smoke residue may buildup on critical parts and damage the projector or its performance**

- ***Consult with your dealer for special installation such as suspending from a ceiling.***
- ***There is 3% tolerance among these numbers due to optical component variations. It is recommended that if you intend to permanently install the projector, you should physically test the projection size and distance using the actual projector in situ before you permanently install it, so as to make allowance for this projector's optical characteristics. This will help you determine the exact mounting position so that it best suits your installation location.***

Locking control keys

With the control keys on the projector locked, you can prevent your projector settings from being changed accidentally (by children, for example). When the **Panel Key Lock** is on, no control keys on the projector will operate except **Power**.

1. Press **Lock** on the remote control.
2. A confirmation message is displayed. Select **Yes** to confirm.

To release panel key lock:

1. Press **Lock** on the remote control.
2. A confirmation message is displayed. Select **Yes** to confirm.



Important

- **If you press **Power** to turn off the projector without disabling panel key lock, the projector will still be in locked status the next time it is turned on.**
- **Keys on the remote control are still functional when panel key lock is enabled.**

Setting the presentation timer

The presentation timer can indicate the presentation time on the screen to help you achieve better time management when giving presentations. Follow these steps to utilize this function:

1. Press **Timer** on the remote control to access the **Presentation Timer** menu or go to the **Option > Presentation Timer** menu and press **▶** to display the **Presentation Timer** page.
2. Highlight **Timer Period** and decide the timer period by pressing **◀/▶**.
3. Press **▼** to highlight **Display Timer** and choose if you want the timer to show up on the screen by pressing **◀/▶**.

Selection	Description
Always	Displays the timer on screen throughout the presentation time.
1 Min/2 Min/3 Min	Displays the timer on screen in the last 1/2/3 minute(s).
Never	Hides the timer throughout the presentation time.

4. Press **▼** to highlight **Timer Position** and set the timer position by pressing **◀/▶**.
Top-Left → Bottom-Left → Top-Right → Bottom-Right
5. Press **▼** to highlight **Timer Counting Direction** and select your desired counting direction by pressing **◀/▶**.

Selection	Description
Count Up	Increases from 0 to the preset time.
Count Down	Decrease from the preset time to 0.

6. To activate the presentation timer, highlight **Start Counting** and select **Start Counting**. You will see the message displaying on the screen.
7. To cancel the timer, go to the **Option > Presentation Timer > Start Counting** menu and highlight **Off**.

Menu operation

The projector has multilingual on-screen display menus that allow you to make image adjustments and change a variety of settings.

How to operate

1. Press **MENU/EXIT** on the projector or **Menu** on the remote control to open the OSD menu.
2. When OSD is displayed, use ◀/▶ to select any feature in the main menu.
3. After selecting the desired main menu item, press ▼ to enter sub-menu for feature setting.
4. Use ▲/▼ to select the desired item and adjust the settings with ◀/▶.
5. Press **MENU/EXIT** on the projector or **Menu** on the remote control, the screen will return to the main menu.
6. Press **MENU/EXIT** twice* on the projector or **Exit** on the remote control to leave and save the settings.

*The first press leads you back to the main menu and the second press closes the OSD menu.

Menu tree

Main Menu	Sub Menu	Settings		
Picture	Color Mode	RGB: Brightest / PC / Movie / ViewMatch / User1 / User2 / White Board / Black Board / Green Board Video: Brightest / Game / Movie / ViewMatch / User1 / User2 / White Board / DICOM SIM / Green Board		
	Reference Mode	RGB: Brightest / PC / Movie / ViewMatch Video: Brightest / Game / Movie / ViewMatch		
	Brightness	0 - 100		
	Contrast	0 - 100		
	Color Setting	Color Temp.	User / Cool / Normal / Warm	
		Red Gain	0 - 100	
		Green Gain	0 - 100	
	User Color	Blue Gain	0 - 100	
		Color	Red / Green / Blue / Cyan / Magenta / Yellow	
		Hue	-99 - +100	
		Saturation	0 - 199	
	White Intensity	Gain	0 - 199	
		Gamma	0 - 10	
	Aspect Ratio	Gamma	1 - 8	
		Aspect Ratio	XGA: Auto/ 4:3/ 16:9 / Wide WXGA: Auto/ 4:3/ 16:9 / 16:10* / Anamorphic * 16:10 only for PJD6544w	
	Dynamic Mode	On / Off		
Keystone	-40 - +40			
3D Settings	3D Sync	On / Off		
	3D Format	Auto / Frame Sequential / Frame Packing / Top-Bottom / Side-by-Side		
	3D Invert	On / Off		
Video/Audio	Frequency	0 - 31		
	Tracking	-5 - +5		
	H Position	-10 - +10		
	V Position	-10 - +10		
	Zoom	0 - +5		
	Video Setting	Sharpness	0 - 31	
		Tint	0 - 100	
		Saturation	0 - 100	
	Audio Setting	Volume	0 - 10	
		Mute	On / Off	
		Audio in 2	Audio In / Microphone In	
Microphone Volume		0 - 10		

Setting	Projector Projection	Front-Table / Front-Ceiling / Rear-Table / Rear-Ceiling		
	Menu Setting	Menu Position	Top-Left / Top-Right / Center / Bottom-Left / Bottom-Right	
		Menu Display Time	5 - 60 Sec	
		OSD Transparency	Off - 90	
	HDMI Format	DVI: RGB Enhance / RGB Normal / YCbCr HDMI: Auto / RGB Full / RGB limited / YCbCr		
	HDMI Range	Normal / Enhance		
	Blank Screen	Black / Red / Green / Blue / Cyan / Yellow / Magenta / White		
	Message	On / Off		
	Auto Source	On / Off		
	Auto Power Off	Off - 60 Minute		
	Sleep Timer	Off -12 Hours		
	Standby Setting	Network	On / Off	
		Active VGA Out	On / Off	
		Active Audio Out	On / Off	
		Quick Power Off	On / Off	
		Smart Restart	On / Off	
		DC12V	On / Off	
	LAN Control Setting	Wired LAN	Status	Disconnect / Connect
			DHCP	On / Off
			Projector IP address	
			Subnet Mask	
			Default Gateway	
			DNS Server	
Wireless LAN		Apply		
		Status		
		SSID		
		IP Address		
		Connection Mode		
Network Restart		Restrat / Cancel		

Option	Closed Caption	Off/ CC1~CC4/ T1~T2		
	Password	Change Password	Input new password	Confirm password
		Password	Yes / No	
		Password Delete	Input currently password	Password Delete Yes/No
	Presentation Timer	Timer Period	0 - 240 Min	
		Display Timer	Always / 1 Min / 2 Min / 3 Min / Never	
		Timer Position	Top-Left / Bottom-Left / Top-Right / Bottom-Right	
		Timer Counting Direction	Count Down / Count Up	
		Start Counting	Start Counting / OFF	
	High Altitude	On / Off		
	Lamp Setting	Lamp Hours		
		Lamp Hours Reset	Yes / No	
		Eco Mode	On / Off	
		Dynamic Eco Timer (RC)	Off / 5 / 10 / 15 / 20 / 25 / 30 min	
	My Button	Brightness / Contrast / Color Setting / Projector Projection / Menu Position / 3D Setting / Eco Mode / Dynamic Mode / OSD Transparency / Closed Caption / Auto Power Off / Sleep Timer / Auto Source		
Pattern	Off / 1 / 2 / 3 / 4 / 5 / User			
CEC	On / Off			
Factory Default	Yes / No			
Language	English / Deutsch / Français / Español / Italiano / Русский / 한국어 / ไทย / Português / 简体中文 / 繁體中文 / 日本語 / Nederlands / Svenska / Türkçe / Suomi / Polski / Indonesia / العربية / हिन्दी			
Information	Input Source			
	Resolution			
	H. Frequency			
	V. Frequency			
	Lamp Hours			
	Mac Address			

Picture

Color Mode

There are many factory presets optimized for various types of images.

- Brightest: Maximizes the brightness of the projected image. This mode is suitable for environments where extra-high brightness is required.
- PC: Is designed for presentations under daylight environment to match PC and notebook coloring.
- Game: Is appropriate for playing games.
- Movie: Is appropriate for playing colorful movies. This mode is suitable for viewing in a blackened (little light) environment
- ViewMatch: Switches between high brightness performance and accurate color performance.
- User 1: Memorize user 1 defined settings.
- User 2: Memorize user 2 defined settings.
- White Board: For white projection screen type.
- DICOM SIM: Recommended for DICOM format files in simulation mode.
- Green Board: For green projection screen type.

Note

- *DCIM SIM option is only for training or reference. It not used for actual diagnosis.*
- *DICOM represents for the Digital Imaging and Communications in Medicine. This is a standard created by the American College of Radiology and the National Electrical Manufacturers Association. This standard specifies the method of digital image data to be transferred from one system to another.*

Reference Mode

Select a picture mode that best suits your need for the image quality and further fine-tune the image. This function is only available when User 1 or User 2 is selected.

- Brightest: Maximizes the brightness of the projected image. This mode is suitable for environments where extra-high brightness is required.
- PC: Is designed for presentations under daylight environment to match PC and notebook coloring.
- Game: Is appropriate for playing games.
- Movie: Is appropriate for playing colorful movies. This mode is suitable for viewing in a blackened (little light) environment
- ViewMatch: Switches between high brightness performance and accurate color performance.

Brightness

Brighten or darken the image.

Contrast

Set the difference between light and dark areas.

Color Setting

Adjust the color temperature. At higher temperature the screen looks colder; at lower temperature, the screen looks warmer. If you select “User”, then you can change the intensity of each of 3 color (Red Gain, Green Gain, Blue Gain) to customize user color temperature.

User Color

User Color provides six sets (RGBCMY) of colors to be adjusted. When you select each color, you can independently adjust its range, hue, saturation and gain according to your preference.

White Intensity

Increase the brightness of white areas.

Gamma

Effect the represent of dark scenery. With greater gamma value, dark scenery will look brighter.

Aspect Ratio

Select how the picture fits on the screen:

- Auto: Scales an image proportionally to fit the projector's native resolution in its horizontal or vertical width. You want to make most use of the screen without altering the source image's aspect ratio.
- 4:3: Scales an image so that it is displayed in the center of the screen with a 4:3 aspect ratio.
- 16:9: Scales an image so that it is displayed in the center of the screen with a 16:9 aspect ratio.
- 16:10: Scales an image so that it is displayed in the center of the screen with a 16:10 aspect ratio.
- Wide / Anamorphic: Minimizes the aspect ratio distortion by maintaining close to the original aspect ratio in the center of the image and distributing the majority of distortion at the edges of the displayed image.

Note

- *Wide for XGA model; Anamorphic for WXGA model.*
- *16:10 only for PJD6544w model .*

Dynamic Mode

Choose “On” to dim the projector lamp which will automatically detect the brightness level of the content and reduce lamp power consumption (up to 70 percent). Choose “Off” to turn off Dynamic Mode.

Note

- *When Dynamic Mode is “On”, Eco Mode will be gray out.*

Keystone

Manually correct distorted images resulting from an angled projection.

Press Keystone ▲ / ▼ on the projector or remote control to display the Keystone correction page.

Press ▲ to correct keystone at the top of the image.

Press ▼ to correct keystone at the bottom of the image.

3D Settings

This projector features a 3D function which enables you to enjoy the 3D movies, videos, and sporting events in a more realistic way by presenting the depth of the images. You need to wear a pair of 3D glasses to view the 3D images.

3D Sync

When you discover the inversion of the image depth, enable this function to correct the problem.

3D Format

Use this function to choose an appropriate 3D format if the projector cannot recognize the 3D format.

If the 3D signal is input from an HDMI 1.4a compatible device, the projector detects the signal for 3D Sync information and once detected, it projects images in 3D format automatically. In other cases, you may need to manually select a 3D Sync format for the projector to project 3D images correctly.

Note

- *3D Format will be available when 3D Sync is “On”.*
- *The default setting is “Auto” when input source is HDMI.*
- *The default setting is “Side-by-Side” when input source is video or computer. “Auto” will be unavailable.*
- *The brightness level of the projected image will decrease.*
- *The Color Mode cannot be adjusted.*

3D Invert

- On: Invert left and right frame contents.
- Off: Default frame contents.

Video/Audio

Frequency

Adjust the timing of the projector relative to the computer.

Note

- *This functions is only supported under computer mode.*

Tracking

Adjust the phase of the projector relative to the computer.

Note

- *This functions is only supported under computer mode.*

H Position (Horizontal Position)

Adjust the image left or right within the projection area.

V Position (Vertical Position)

Adjust the image up or down within the projection area.

Zoom

Using the remote control

1. Press Magnify on the remote control to display the Zoom bar.
2. Press ◀/▶ to magnify the picture to a desired size.
3. Press “Enter” on the projector or remote control to switch to the panning mode and press the directional arrows to navigate the picture. The zoom bar needed to be shown on screen if we want to switch the panning mode.
4. To reduce size of the picture, press Magnify and press ◀ repeatedly until it is restored to the original size.

Using the OSD menu

1. Press **MENU/EXIT** on the projector or **Menu** on the remote control and then press ▶ until the Video/Audio menu is highlighted.
2. Press ▶ to highlight Zoom.
3. Repeat steps 2-4 in the section of Using the remote control above.

Video Setting

Allow you to enter the Video Setting menu.

- Sharpness: Sharpen or soften the image.
- Tint: Shift colors toward red or green.
- Saturation: Adjust a video image from black and white to fully saturated color.

Audio Setting

Allow you to enter the Audio Setting menu.

- Volume: Adjust the projector’s volume level.
- Mute: Toggles the projector audio between on and off.
- Audio In: Switch Audio in 2 function for Audio in or Microphone in function.
- Microphone Volume: Adjust the microphone’s volume level.

Setting

Projector Projection

Adjust the picture to match the orientation of the projector: upright or upside-down, in front of or behind the screen. Invert or reverse the image accordingly.

Menu Setting

Allow you to enter the Menu Setting menu.

- Menu Position: Choose the menu location on the display screen.
- Menu Display Time: Duration of OSD menu display countly starts (at idle state by second).
- OSD Transparency: Select to change the transparency level of the OSD background.

HDMI Format

Selects appropriate HDMI format automatically or manually.

Note

- *This function is only available when the HDMI-input port is in use.*
- *When HDMI Format is “Auto”, HDMI Range will be gray out.*

HDMI Range

- Enhanced: The range for HDMI output signal is from 0 - 255.
- Normal: The range for HDMI output signal is from 16 - 235.

Blank Screen

To select the screen color when Blank function is active.

Message

Enable or disable the message box at the right bottom of the screen.

Auto Source

Automatically scan through all the input source if the function in the OSD menu is On. The function will stop the signal auto scan process and fix the signal source you preferred if you turn Off the Auto Source.

Auto Power Off

Allows the projector to turn off automatically if no input signal is detected after a set period of time.

Sleep Timer

No matter whether the projector detect signal or not, the projector will turn off automatically when the countdown has finished.

Standby Setting

Network

Set whether the network function works when the projector is in standby (powered off but connected to AC power).

Note

- *Less than 0.5W power consumption when network is turned OFF.*
- *When Power Saving is On, the Active VGA out and Active Audio out settings are not available.*

Active VGA Out

Set whether the VGA OUT function works when the projector is in standby (powered off but connected to AC power).

Active Audio out

Set whether the audio out function works when the projector is in standby (powered off but connected to AC power).

Quick Power Off

- On: The projector will directly shut down without cooling procedure.
- Off: The projector will shut down following normal cooling procedure.

Smart Restart

Selecting On enables you to restart the projector immediately within 3 minutes after turning it off. After 3 minutes, if the projector is not turned on again, it will directly enter the standby mode.

DC12V

Set whether the DC12V function works when the projector is in standby (powered off but connected to AC power).

LAN Control Setting

Wired LAN

Allow you to configure the wired LAN settings. Refer to page [38](#).

- Status: Display the projector's status.
- DHCP: Abbreviation for Dynamic Host Configuration Protocol. This protocol automatically assigns IP Address to networked devices.
 - When the "DHCP" sets to "On", it takes some time to obtain IP address from DHCP server.
 - When the "DHCP" sets to "Off", that means user will set IP address by manually.
- Projector IP Address: Numerical address to identify networked computers. This function can only be used when DHCP is set to Off.
 - The IP Address is the number that identifies this projector on the network. You cannot have two devices with the same IP Address on the same network.
 - The IP Address "0.0.0.0" is prohibited.
- Subnet Mask: A numeric value to define the number of bits used for a network address of a divided network (or subnet) in an IP Address. This function can only be used when DHCP is set to Off.
 - The Subnet Mask "0.0.0.0" is prohibited.
- Default Gateway: A server (or router) to communicate across networks (subnets) that are divided by Subnet Mask. This function can only be used when DHCP is set to Off.
- DNS Sever: Setup DNS server address when DHCP is disable.
- Apply: Save and execute the wired LAN settings.

Wireless LAN

Allow you to configure the wireless LAN settings. Refer to page [39](#).

- Status: Display the projector's status.
- SSID: Display the projector's SSID information.
- IP Address: Numerical address to identify networked computers. This function can only be used when DHCP is set to Off.
 - The IP Address is the number that identifies this projector on the network. You cannot have two devices with the same IP Address on the same network.
 - The IP Address "0.0.0.0" is prohibited.
- Connection Mode: Methods for connecting to wireless networks with Wi-Fi enabled devices.

Network Restart

If you encounter a malfunction of network connection and need to restart the network settings, you can go into the **Setting > LAN Control Setting > Network Restart** menu to restart network function.

Option

Closed Caption

Enable or disable closed captions by selecting CC1 (closed caption1, the most common channel), CC2, CC3, CC4, T1, T2 or OFF.

Password

Set, change or delete the password. When the password function is added, image projection will require to input the preset password when turning on the projector.

Presentation Timer

Remind the presenter to finish the presentation within a certain time frame.

High Altitude

Use this function to allow the fans operates at full speed continuously to achieve proper high altitude cooling of the projector.

Lamp Setting

Allow you to enter the Lamp Setting menu.

- Lamp Hours: Display the lamp's elapsed operating time (in hours).
- Lamp Hours Reset: Reset the lamp Hour to 0 hours.
- Eco Mode: Use this function to dim the projector lamp light output which will lower power consumption and increase lamp life.
- Dynamic Eco Timer (RC): Sets the timer of triggering Dynamic Eco function. The projector lamp will start dimming when the timer period has finished.

My Button

Allow user to define a short cut key on the remote control, and the function item is selected in OSD menu.

Pattern

The projector can display several test patterns. It helps you adjust the image size and focus and check that the projected image is free from distortion.

CEC

If the projector is connected to a DVD player with HDMI cable, selecting On will activate the DVD player at a time when powering on the projector.

Factory Default

Restore settings to factory default.

Note

- ***The following settings will still remain: Keystone, Password, Projector Projection, High Altitude and Language.***

Language

Select the language used by the on-screen menu.

Information

Input Source

Display the current input source.

Resolution

Display current input source resolution.

H. Frequency

Display current image horizontal frequency.

V. Frequency

Display current image vertical frequency.

Lamp Hours

Display the lamp's elapsed operating time (in hours).

MAC Address

Display the MAC address.

Controlling the projector through a LAN environment

You can manage and control the projector from one or more remote computers when they are properly connected to the same local area network.

Wired connection

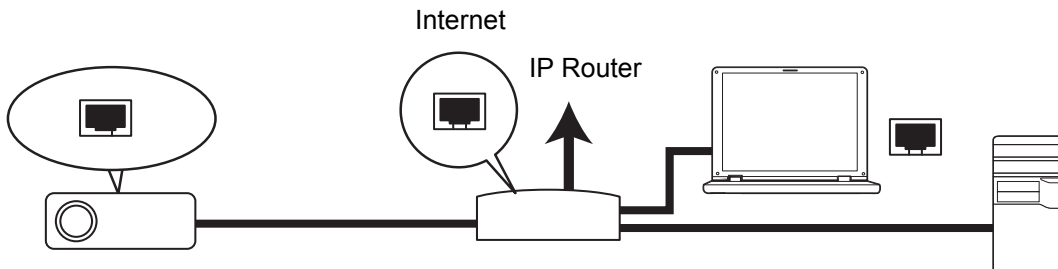

If you are in a DHCP environment:

1. Take a RJ45 cable and connect one end to the RJ45 LAN input jack of the projector and the other end to the RJ45 port on your Ethernet or router.
2. Press **MENU/EXIT** on the projector or **Menu** on the remote control and then go to **Setting > Lan Control Setting** menu.
3. Highlight **Wired LAN** and press **ENTER** on the projector or **Enter** on the remote control.
4. Make sure the **Status** is **Connect**.
5. Press **▼** to highlight **DHCP** and press **◀/▶** to select **On**.
6. Press **▼** to highlight **Apply** and press **ENTER** on the projector or **Enter** on the remote control.
7. Please wait for around 15 - 20 seconds, and then re-enter the Wired LAN page. The **Projector IP Address**, **Subnet Mask**, **Default Gateway**, and **DNS Sever** settings will be displayed. Note down the IP address displayed in the **Projector IP Address** row.

Important

- *If the Projector IP Address still does not appear, contact your network administrator.*
- *If the RJ45 cables are not properly connected, the IP Address, Subnet Mask, Default Gateway, and DNS settings will display 0.0.0.0. Make sure the cables are properly connected and perform the procedures above again.*
- *If you wish to connect to the projector in its standby mode, be sure you have selected RJ45 and obtained the IP Address, Subnet Mask, Default Gateway, and DNS information when the projector is on.*

If you are in a non-DHCP environment:

1. Repeat steps 1-4 above.
2. Press **▼** to highlight **DHCP** and press **◀/▶** to select **Off**.
3. Contact your ITS administrator for information on the **Projector IP Address**, **Subnet Mask**, **Default Gateway**, and **DNS Sever** settings.

4. Press ▼ to select the item you want to modify and press **ENTER** on the projector or **Enter** on the remote control.
5. Press ◀ / ▶ to move the cursor and then enter the value.
6. To save the settings, press **ENTER** on the projector or **Enter** on the remote control. If you do not want to save the settings, press **MENU/EXIT** on the projector
7. or **Menu** on the remote control.
8. Press ▼ to highlight **Apply** and press **ENTER** on the projector or **Enter** on the remote control.

Important

- *If the RJ45 cables are not properly connected, the IP Address, Subnet Mask, Default Gateway, and DNS settings will display 0.0.0.0. Make sure the cables are properly connected and perform the procedures above again.*
- *If you wish to connect to the projector in its standby mode, be sure you have selected RJ45 and obtained the IP Address, Subnet Mask, Default Gateway, and DNS information when the projector is on.*

Wireless connection

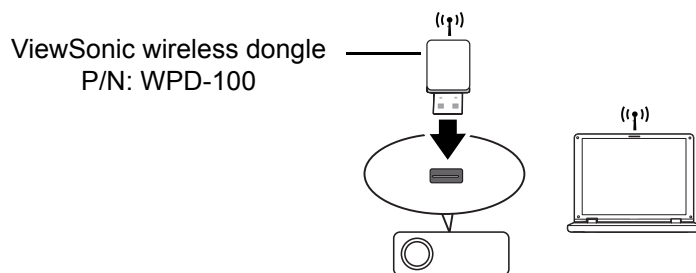

To connect to the projector wirelessly, you have to plug a ViewSonic wireless dongle (optional) to the Type A USB connector on the projector, and then only a few OSD configuration steps are required.

1. Make sure the projector is turned on.
2. Press **MENU/EXIT** on the projector or **Menu** on the remote control and then go to **Setting > LAN Control Setting** menu.
3. Highlight **Wireless LAN** and press **ENTER** on the projector or **Enter** on the remote control.
4. Make sure the **Status** is **Connect**.
5. Make sure the **SSID** information is displayed.
6. In **AP** mode, you need to use your computer's wireless connection utility to search the projector's SSID and connect to it. The password of connection the Wi-Fi for the first time is "87654321". Then you can search the projector with vsPresenter. To use **Client** mode, you should connect both your computer and projector to the same AP router and make connections with the IP address.

About AP and Client modes

In AP mode, you need to use your computer's wireless connection utility to search for the projector's SSID and connect to it. Then you can search for the projector with vsPresenter. In Client mode, you should connect both your computer and projector to the same AP router and make connections with the IP address.

The following diagram describes how to access the Internet in AP and Client modes.

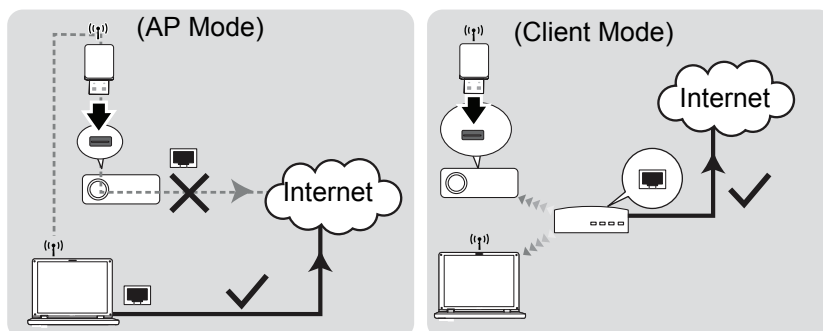

Important

- *If you need more information about AP and Client modes, please refer to user documentations for Wireless Routers which are usually available on 3C stores.*

Controlling the projector through a web browser

Once you have the correct IP address for the projector and the projector is on or in standby mode, you can use any computer that is on the same local area network to control the projector.

Important

- *If you are using Microsoft Internet Explorer, make sure it is version 7.0 or higher.*
- *The screenshots in this manual are for reference only, and may differ from the actual design.*

1. Enter the address of the projector in the address bar of your browser and press Enter.

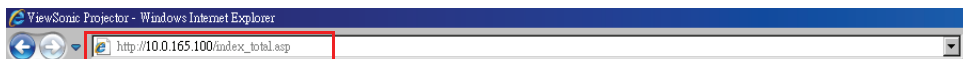

2. The ViewSonic Network Control webpage opens.

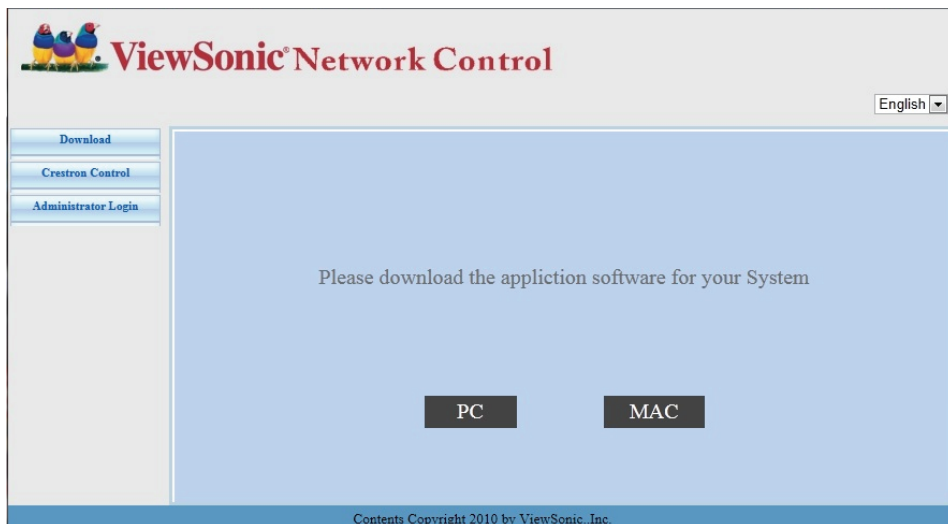

3. Click Administrator Login and enter the default password "0000" to login.

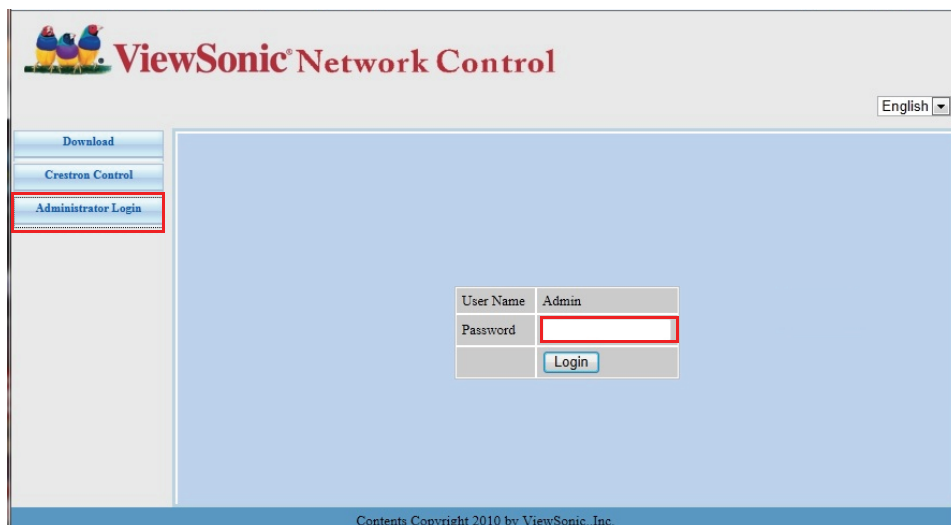

- The main page of the ViewSonic Network Control webpage appears as below.

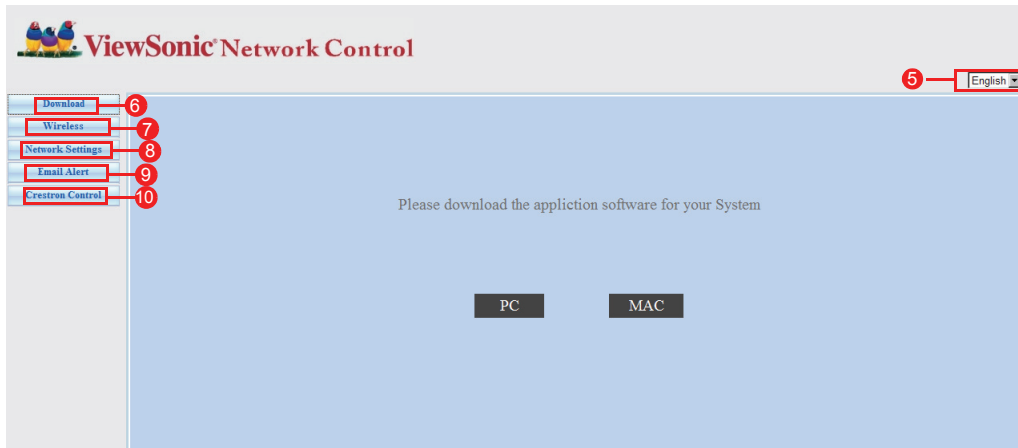

- To change the language for the web pages, click the down arrow to reveal a drop down list and select a desired language.
- To download vsPresenter, click PC or MAC depending on your computer operating system. See "[Displaying images through vsPresenter](#)" on page 46 for details.
- Wireless page displays the Wireless Lan information.
- Network Settings: Provides network settings.
- Email Alert: Allows you to setup the mail server and send system error messages to your ITS administrator.
- The Crestron (eControl) page displays the Crestron eControl user interface. See "[About Crestron control](#)" on page 42 for details.

About Crestron control

- The Crestron (eControl) page displays the Crestron eControl user interface. The eControl page provides a variety of virtual keys to control the projector or adjust the projected pictures.

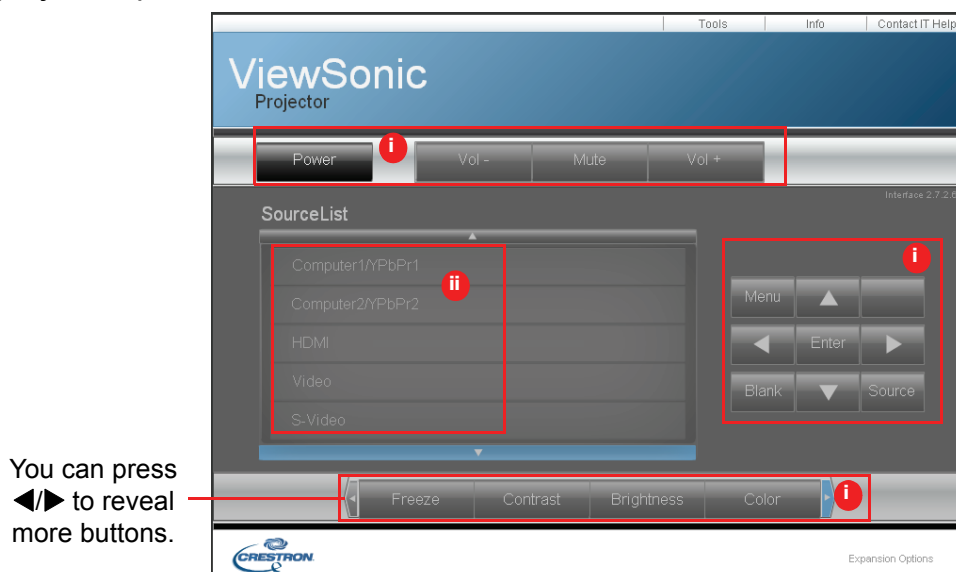

- These buttons function the same as the ones on the OSD menus or remote control.

- ii. To switch between input signals, click on your desired signal.

Important

- **The Menu button can also be used to go back to previous OSD menus, exit and save menu settings.**
- **The source list varies according to the connectors available on the projector.**
- **When you use the projector control panel or remote control to change the OSD menu settings, it may take a while for the web browser to synchronize these changes with the projector.**

2. The tools page allows you to manage the projector, configure the LAN control settings and secure access of remote network operation on this projector.

- i. This area is only used with a Crestron Control System. Please contact Creston or refer to the Crestron user manual for setup information.
- ii. This area is used for naming the projector, associating it with a particular location, assigning a responsible party to it, and adjusting network settings.
- iii. This area is used to set User and Admin passwords. When password protection is enabled, unauthorized changes to the projector configuration will be avoided.

Important

- **To prevent errors, only input the English alphabet and digits on the tools page.**
 - **After making the adjustments, press the Send button and the data will be saved for the projector.**
- iv. Press **Exit** to go back to the remote network operation page.

Please pay attention to the limitation of input length (including space and other punctuation keys) in the list below:

Category Item	Input Length	Maximum Number of Characters
Crestron Control	IP Address	15
	IP ID	2
	Port	5
Projector	Projector Name	10
	Location	9
	Assigned To	9
Network Configuration	DHCP (Enabled)	(N/A)
	IP Address	15
	Subnet Mask	15
	Default Gateway	15
	DNS Server	15
User Password	Enabled	(N/A)
	New Password	20
	Confirm	2
Admin Password	Enabled	(N/A)
	New Password	20
	Confirm	20

3. The info page displays the information and status of this projector.

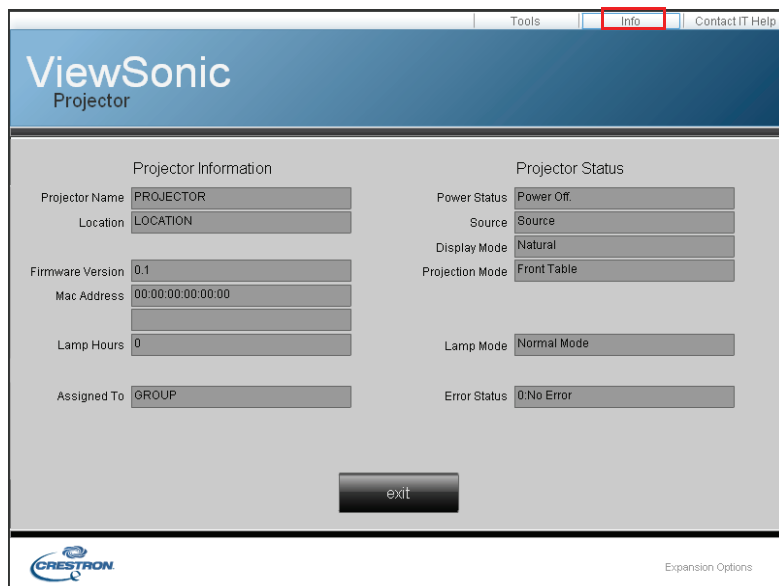

Press **exit** to go back to the Crestron remote network operation page.

4. After pressing the button “Contact IT Help”, the Title window will appear in the upper right corner of the screen. You will be able to deliver messages to RoomView software administrators/users who connect to the same local area network.

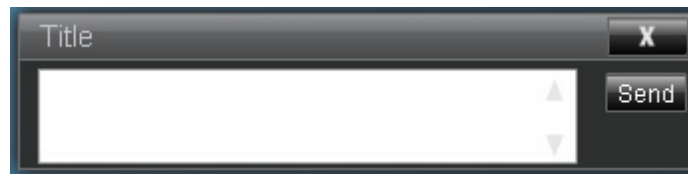

Important

- Please only deliver the messages in English letters and digits.

For more information, visit <http://www.crestron.com> and www.crestron.com/getroomview.

****Crestron RoomView**

On the "Edit Room" page, enter the IP Address (or hostname) as shown on the projector's on-screen display (OSD) menu, and "05" for IPID, "41794" for the reserved Crestron control port.

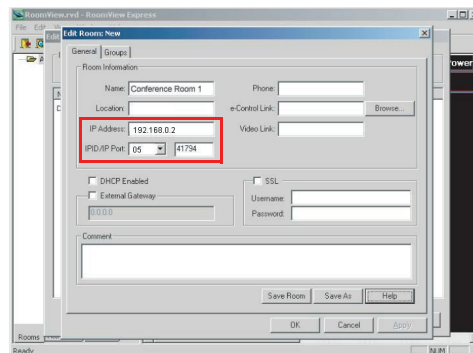

About Crestron RoomView setting and command method, please access below website to get RoomView User Guide and more information:

http://www.crestron.com/features/roomview_connected_embedded_projectors_devices/resources.asp

Displaying images through vsPresenter

Downloading and installing vsPresenter

The vsPresenter is an application running on the host PC. It helps connect your computer to an available network projector and transfer the desktop content to the network projector via local network connection.

1. Enter the main page of Network Control. See steps 1-2 on page 41 for details.
2. Download vsPresenter.
3. When the download is complete, install the software to your computer by clicking the exe file. Follow the on-screen instructions to complete the installation.
4. Launch vsPresenter.
5. Select display zone by clicking 1, 2, 3, 4, L, R, All, or Background and then enter the password. The default password is "0000".

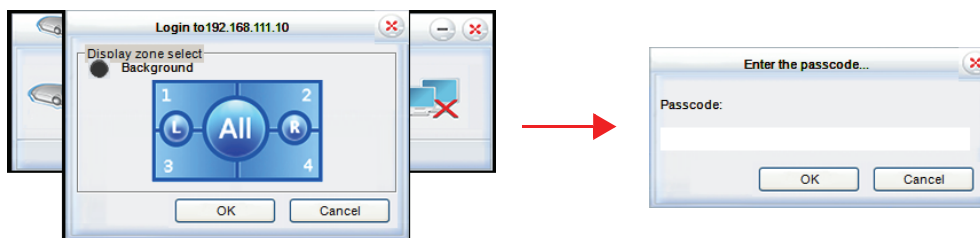

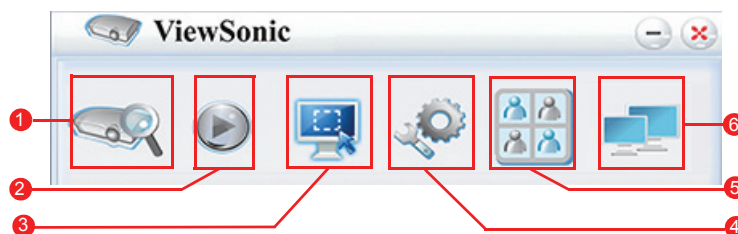

Using vsPresenter

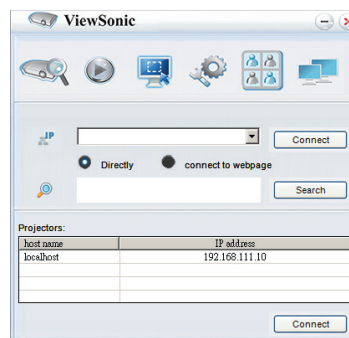

1. The Search page allows you to search and connect to a projector.



- i. To connect to a projector, select Directly then type the projector IP address and click Connect.

- ii. To search for projectors, simply click Search to list all the projectors on the same local area network. Click the desired projectors in the Search result list, and click Connect directly. You can also type a desired projector name and click Search.
- iii. You can link to the ViewSonic webpage control system on page 42.
2. If you want to freeze the projected image on the screen, press . Any further movements will be not been seen on the screen until  is pressed.
3. You can choose a mirror mode or extension mode from here.

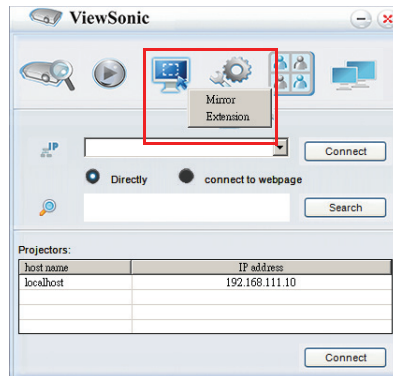

- i. Mirror mode is to display the content in your computer.
- ii. Extension mode is to extend the computer's display to the projected screen.
4. The Setting page allows you to configure vsPresenter.







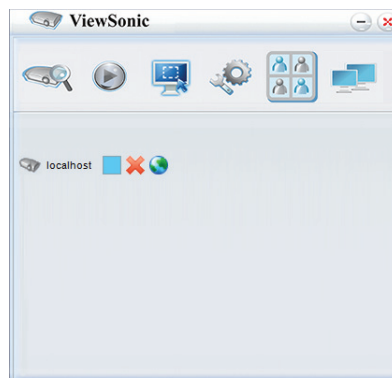



- i. To use Compatible Mode, click On.
- ii. To use Audio Streaming, click On. Click Apply.
- iii. To select the image quality for video or presentation, click the down arrow to reveal a drop-down list and select a desired quality type.
- iv. The Software Information is available on this page.

5. You can manage the connected projectors listed under vsPresenter Management.

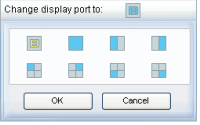

- Under a conference mode:
 1. Only the administrator can take control.
 2. A projector can display up to 4 computer screens.
- You can set the name of your computer under vsPresenter Management.
- For details about the icons, please see the following:

Icon	Description	Icon	Description
	You are a normal user and have no access to change the password.		Disconnects from the projector.
	You are an administrator and have authority to change the password.		Opens the web page of the Network Control.
	You are the user of the projector.		There is another user of the projector.
	You are an administrator of the projector.		You are a normal user of the projector.
	Sets a display zone for the projector.		

6. Disconnect

To disconnect from the projector(s), click the Disconnect icon.

Important

- ***Be sure to turn off other virtual network control programs before using vsPresenter.***

Displaying pictures with a USB storage device

The projector is built-in an application which can display packaged images on a USB storage device. It can eliminate the need for a computer source.

To display the images on a USB storage device:

1. Plug the USB storage device into the **TYPE A USB** socket.
2. Press the **Source** button and choose the USB A (Type-A) input. Note: If no other sources are connected and **Auto Source** is on, the projector will automatically select the USB A source.
3. Press Enter and use ▲/▼ to select one of the EZ Media mode.

Photo mode

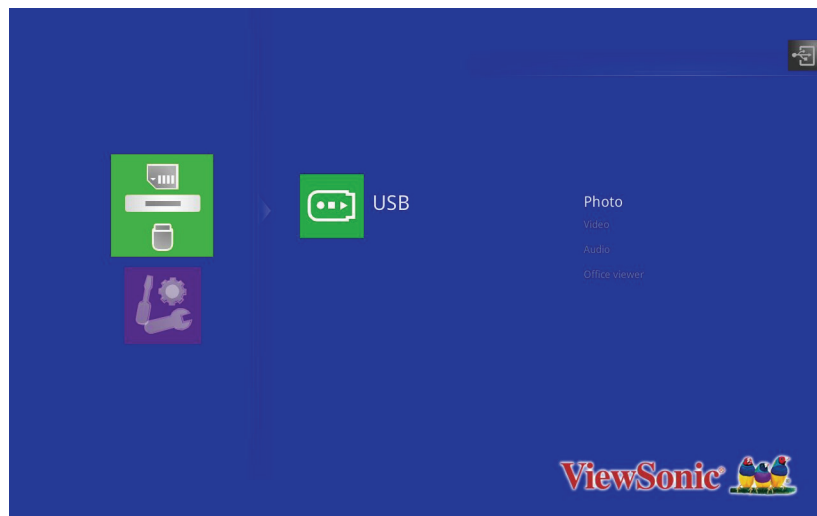

Folders and supported files are represented in thumbnail mode.



Press button	Action
Up	Scroll through the thumbnails
Down	
Left	
Right	
Enter	Open a file
Exit	Go back to Photo mode

Displaying a picture

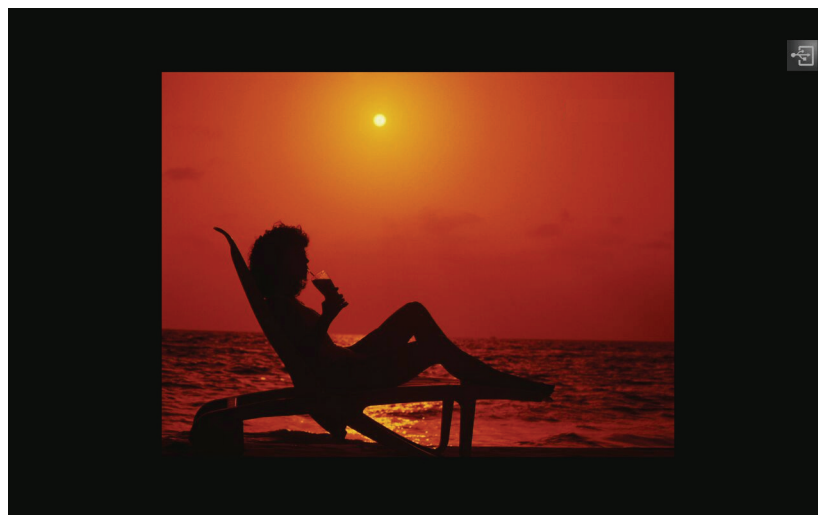

- Press AutoSync on the remote control to display OSD control menu.

Press button	Action
Up	Go to previous photo.
Down	Go to next photo.
Enter	Start slideshow.
Exit	Go back to thumbnail file.

Slideshows



- Photo slideshow duration time includes 2 sec, 5, sec and 10 sec.

Audio mode

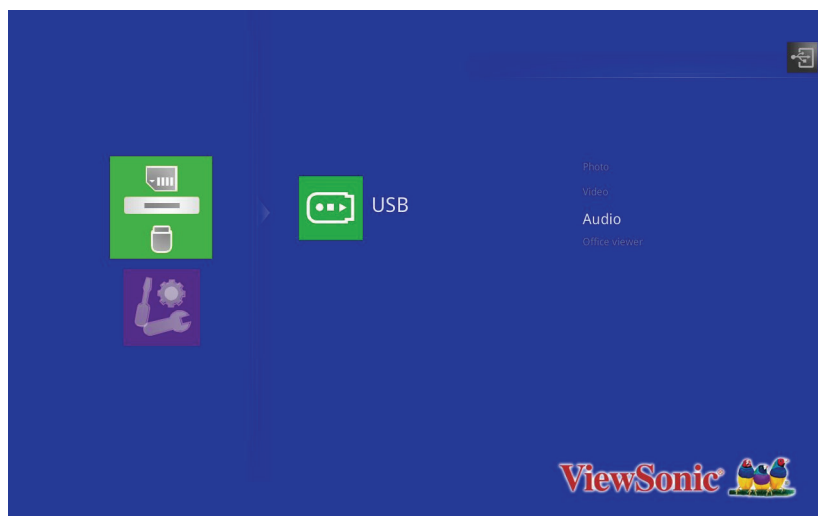

Audio playlist is displayed on the screen.

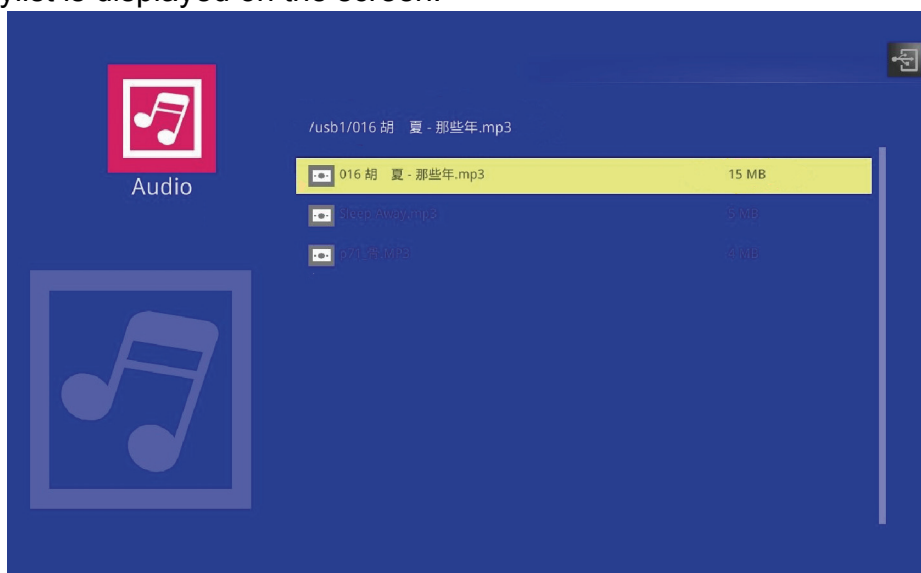

Press button	Action
Up	Go to previous audio
Down	Go to next audio
Enter	Play audio
Exit	Go back to Audio mode

When audio is playing



Press button	Action
Up	Go to previous audio
Down	Go to next audio
Left	Fast backward play
Right	Fast forward play
Enter	Play/pause
Exit	Go back to playlist

Video mode

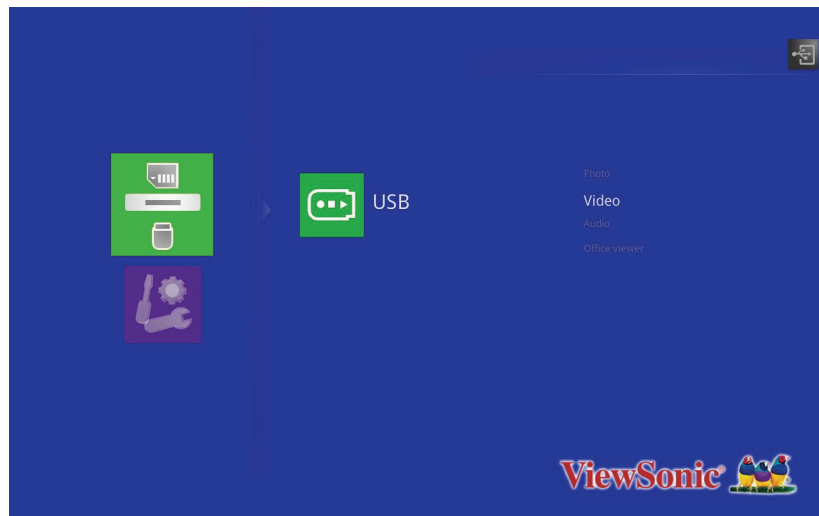

Video playlist is displayed on the screen.

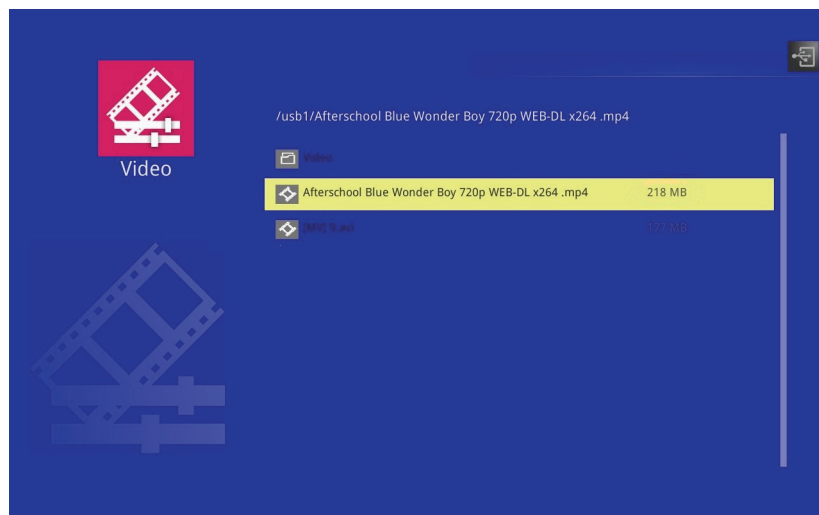

Press button	Action
Up	Go to previous video
Down	Go to next video
Enter	Play video
Exit	Go back to Video mode

When video is playing



- The OSD control menu displays for few seconds. To display it again, press Enter.

Press button	Action
Up	Go to previous video
Down	Go to next video
Left	Fast backward play
Right	Fast forward play
Enter	Play/pause
Exit	Go back to playlist

Office Viewer mode

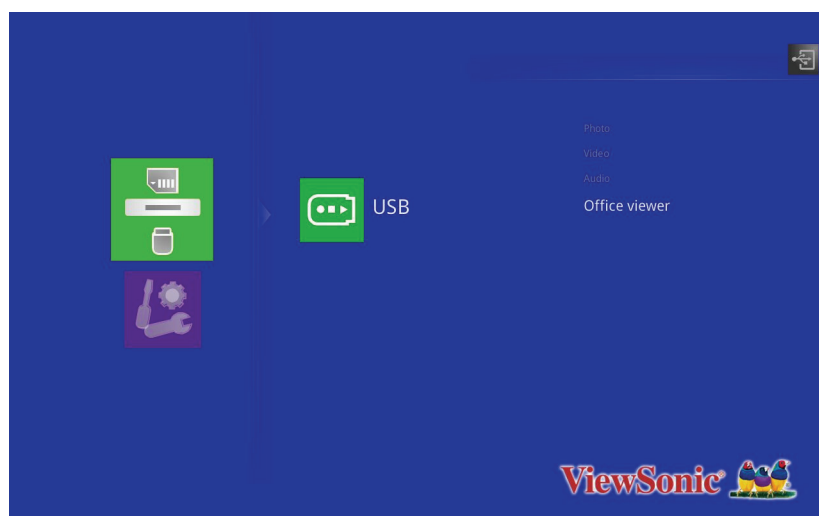

Office file list is displayed on the screen.

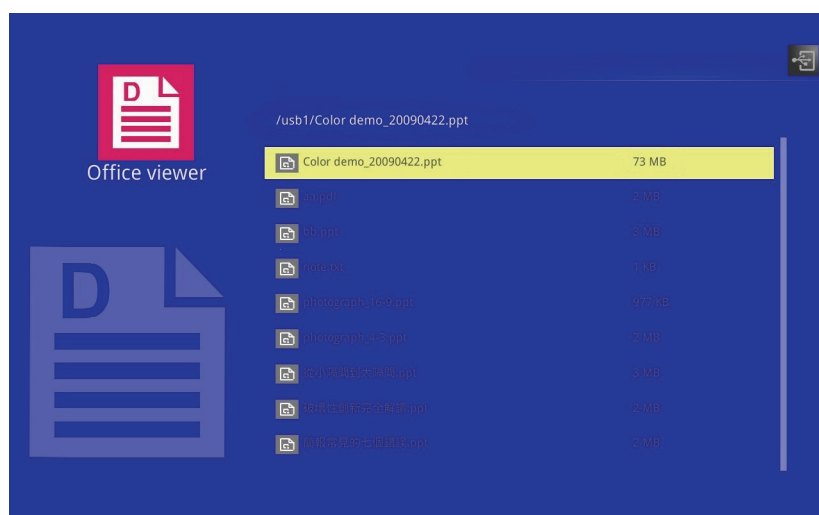

Press button	Action
Up	Go to previous file
Down	Go to next file
Enter	Open a file
Exit	Go back to Office Viewer mode

Note

- *PJD6345 support up to 1600x1200 resolution.*
- *PJD6544w support up to 1680x1050 resolution.*

When Office file is displaying

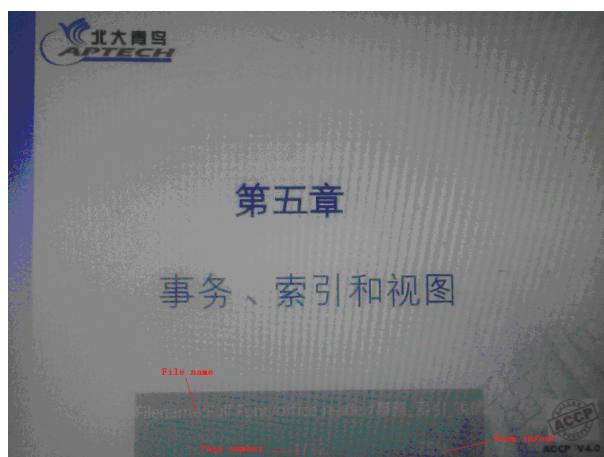

Press button	Action
Up	Page up
Down	Page down
Left	Zoom out
Right	Zoom in
Exit	Go back to file list

Settings

System	Description
Version	Display current EZ Media firmware version.
Language	Sets EZ Media on-screen display language.
Update	Sets update method.
Output Mode	Sets output mode.

Video	Description
Display Ratio	Sets display ratio.
Repeat Mode	Sets repeat mode.

Audio	Description
Repeat Mode	Sets repeat mode.

Photo	Description
Display Ratio	Sets display ratio.
Slideshow	Sets whether to activate slide shows.
Slideshow Duration	Sets the time interval each image displays.

Supported file formats

1. Images

Image Format	Profile	Color Space	Size Limitation
JPEG	Baseline	YUV400	No limit
		YUV420	No limit
		YUV422	No limit
		YUV440	No limit
		YUV444	No limit
	Progressive	YUV400	Width <= 10240 && height <= 6400
		YUV420	
		YUV422	
		YUV440	
		YUV444	
BMP	No limit	No limit	No limit

2. Audio

Audio Format	Sample rate (KHz)	Bit Rate (Kbps)
OGG	8-48	64-320
ADPCM-WAV	8-48	32-384
PCM-WAV	8-48	128-1536
AAC	8-48	8-256

3. Voice Record

File Format	Audio Format	Sample rate (KHz)	Bit Rate (Kbps)
.wav	IMA-ADPCM	8	32
		16	64
		24	192
		48	384

4. Video

File Extensions	Audio/Video	Codec	Profile/ Level Support	Explanation
.avi .divx .mkv	Video	MJPEG	No limit	
		H.264/AVC	Up to High Profile , Levels 1- 4.1 (1080P 30fps 20Mbps)	Support less than 4 reference frames
		XVID	Up to Advance Sim- ple profile (1080P 30fps 20Mbps)	
		MPEG2	Main profile, Low and Main Levels (1080P 30fps 20Mbps)	
		MPEG4	Advanced Simple Pro- file (frame picture) , Levels 0-5 (1080P 30fps 20Mbps)	
.ts	Video	MPEG2	Main profile, Low and Main Levels (1080P 30fps 20Mbps)	
		H.264/AVC	Up to High Profile , Levels 1- 4.1 (1080P 30fps 20Mbps)	Support less than 4 reference frames
.dat .vob .mpg .mpeg	Video	MPEG1	Main profile, Low and Main Levels (1080P 30fps 20Mbps)	D-picture not support
		MPEG2	Main profile, Low and Main Levels (1080P 30fps 20Mbps)	
	Audio	MPEG-1 Layer I, II		
		MPEG-1 Layer III (mp3)		
.mov .mp4	Video	MPEG4	Advanced Simple Pro- file (frame picture) , Levels 0-5 (1080P 30fps 20Mbps)	
		H.264/AVC	Up to High Profile , Levels 1- 4.1 (1080P 30fps 20Mbps)	Support less than 4 reference frames

5. Subtitle

Format	Font	Subtitle Size
Standard SRT	UTF-8 / UTF-16	4bits up to 448x200 2bits up to 896x200

Note: DO NOT support mixed code in subtitle files.

6. Pícsel Office Viewer

File Format	Support Version	Pages/Lines Limitation	Size Limitation	Comment
Adobe PDF	PDF 1.0	Up to 1000 pages (One File)	Up to 50MB	-
	PDF 1.1			
	PDF 1.2			
	PDF 1.3			
	PDF 1.4			

MS Word	British Word 95. Word 97, 2000,2002, 2003.	Because office viewer does not load all pages of MS Word file at the same time, there are no obvious limitations of page and line.	Up to 50MB	Not support Bold Text in Simple Chinese front
	Word 2007(.docx),2010(.docx)			
MS Excel	British Excel 5, 95.	Row Limit: up to 595	Up to 15MB	Not support password-protected sheets
	Excel 97, 2000, 2002, 2003.	Column Limit: up to 256		
	Excel 2007(.xlsx),2010(.xlsx).	Sheet: up tp 100		
	Office XP Excel.	Note: Any one of three limitations above can not appear on one excel file simultaneously		
MS Power-Point	British PowerPoint 97.	Up to 1000 pages (One File)	Up to 19MB	No support SlideShow order
	PowerPoint 2000, 2002, 2003.			
	PowerPoint 2007(.pptx).			
	PowerPoint 2010(.pptx),.			
	Office XP PowerPoint.			
	PowerPoint presentation- -2003 andearlier(.ppx)			
	PowerPoint presentation- -2007 and 2010(.ppsx)			

Maintenance

The projector needs proper maintenance. You should keep the lens clean as dust, dirt or spots will project on the screen and diminish image quality. If any other parts need replacing, contact your dealer or qualified service personnel. When cleaning any part of the projector, always switch off and unplug the projector first.

Warning

- ***Never open any of the covers on the projector. Dangerous electrical voltages inside the projector can cause severe injury. Do not attempt to service this product yourself. Refer all servicing to qualified service personnel.***

Cleaning the Lens

Gently wipe the lens with lens cleaning paper. Do not touch the lens with your hands.

Cleaning the Projector Housing

Gently wipe with a soft cloth. If dirt and stains are not easily removed, use a soft cloth dampened with water, or water and neutral detergent, and wipe dry with a soft, dry cloth.

Note

- ***Turn off the projector and remove the AC power cord from the power outlet before beginning maintenance work.***
- ***Make sure the lens is cool before cleaning.***
- ***Do not use detergents or chemicals other than those noted above. Do not use benzene or thinners.***
- ***Do not use chemical sprays.***
- ***Use a soft cloth or lens paper only.***

Replacing the Lamp

As the projector operates over time, the brightness of the projector lamp gradually decreases and the lamp becomes more susceptible to breakage. We recommend replacing the lamp if a warning message is displayed. Do not attempt to replace the lamp yourself. Contact the qualified service personnel for replacement.

Type number:

PJD6345	PJD6544w
RLC-084	RLC-084

Note

- *The lamp is extremely hot right after turning off the projector. If you touch the lamp, you may scald your finger. When you replace the lamp, wait for at least 45 minutes for the lamp to cool down.*
- *Do not touch the lamp glass at any time. The lamp may explode due to improper handling, including the touching of the lamp glass.*
- *Lamp lifetime may differ from lamp to lamp and according to the environment of use. There is no guarantee of the same lifetime for each lamp. Some lamps may fail or terminate their lifetime in a shorter period of time than other similar lamps.*
- *A lamp may explode as a result of vibration, shock or degradation as a result of hours of use as its lifetime draws to an end. Risk of explosion may differ according to the environment or conditions in which the projector and lamp are being used.*
- *Wear protective gloves and eyeglasses when fixing or detaching the lamp.*
- *Faster on-off-cycles will damage the lamp and reduce lamp life. Wait at least for 5 minutes to turn off the projector after powering on.*
- *Do not operate the lamp in proximity to paper, cloth, or other combustible material nor cover it with such materials.*
- *Do not operate the lamp in an atmosphere containing an inflammable substance, such as thinner.*
- *Thoroughly ventilate the area or the room when operating the lamp in an oxygen atmosphere (in the air). If ozone is inhaled, it could cause headaches, nausea, dizziness, and other symptoms.*
- *The inorganic mercury is involved in the lamp. If the lamp bursts, the mercury inside the lamp will be exposed. Leave the area immediately if the lamp shatters while being operated and ventilate the area for at least 30 minutes in order to avoid the inhalation of mercury fumes. Otherwise it could be harmful to user's health.*

1. Turn off the projector.
2. If the projector is installed in a ceiling mount, remove it
3. Unplug the power cord.
4. Loosen the screw in the side of the lamp cover and remove the cover.
5. Remove the screws from the lamp module, raise the handle, and lift out the module.
6. Insert the new lamp module into the projector and tighten the screws.
7. Replace the lamp cover and tighten the screw.
8. Turn on the projector. If the lamp does not turn on after the warm-up period, try reinstalling the lamp.
9. Reset the lamp hour. Refer to the “**Option > Lamp Setting**” menu.

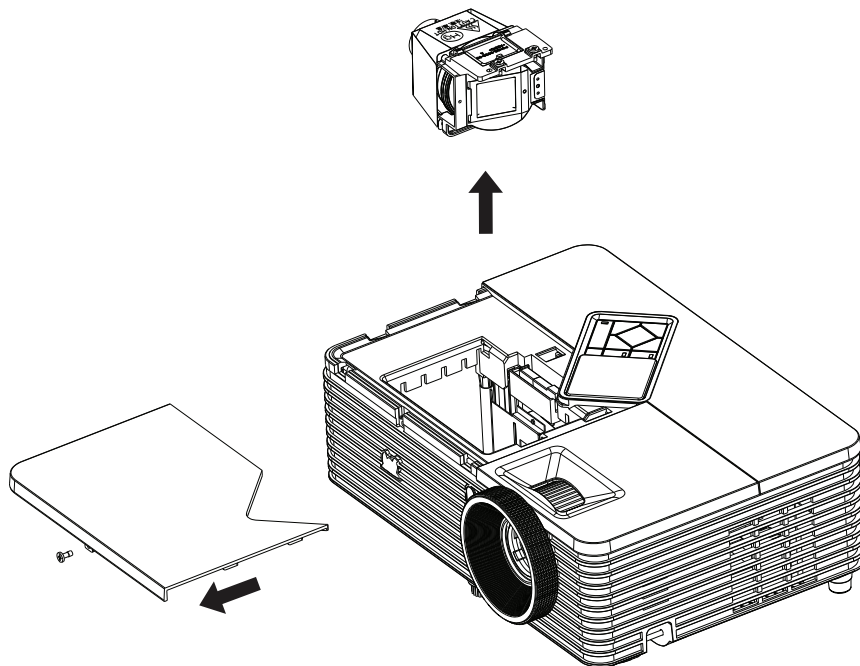

Note

- ***Dispose the used lamp according to local regulations.***
- ***Ensure that screws are tightened properly. Screws not tightened fully may result in injury or accidents.***
- ***Since the lamp is made of glass, do not drop the unit and do not scratch the glass.***
- ***Do not reuse the old lamp. This could cause the lamp to explode.***
- ***Be sure to turn off the projector and unplug the AC power cord before replacing the lamp.***
- ***Do not use the projector with the lamp cover removed.***

Specifications

Model name	PJD6345	PJD6544w
Display system	Single 0.55" DLP panel	Single 0.65" DLP panel
Resolution	XGA (1024 × 768)	WXGA (1280 × 800)
Optical Zoom	1.1X	1.2X
F/No.	1.97 - 2.17	2.58
Focal length	21.95 - 24.18mm	21 - 25.6mm
Screen size	30" - 300"	30" - 300"
Lamp	240W	
Input terminal	D-Sub 15-pin x 2, S-Video x 1, Video x 1, Audio signal input (3.5 mm stereo mini jack) x 2, HDMI x 1, 3.5 mm Mic input x1, Type A USB x1 (supports USB flash drive display and wireless dongle for USB display), Type mini-B USB x1 (supports USB display)	
Output terminal	D-Sub 15 pin x 1, Audio signal output (3.5 mm stereo mini jack) x 1	
Control terminal	RS-232 x 1, Type B USB x 1 (supports firmware upgrade and remote mouse control), RJ45 x 1, 12-Vdc trigger output x 1	
Speaker	16 watt x 1	
Video compatibility	NTSC, NTSC 4.43 PAL, PAL-N, PAL M SECAM, HDTV (480i/p, 576p, 720p, 1080i/p), Composite video	
Scanning frequency Horizontal frequency Vertical frequency	31 - 100 KHz 24 - 120 Hz	
Environment	Operating: Temperature: 0°C to 40°C Humidity: 10%-80% Storage: Temperature: -20°C to 60°C Humidity: 30%-85%	
Power requirement	AC 120-240 V, 50 - 60 Hz, 3.2A	
Power consumption	315 W (Max.)	
Dimension (W x D x H)	294 x 219 x 113 mm	
Weight	2.1 kg (4.6 lbs)	
Note: Design and Specifications are subject to change without prior notice.		

Dimensions

294 mm (W) x 219 mm (D) x 113 mm (H)

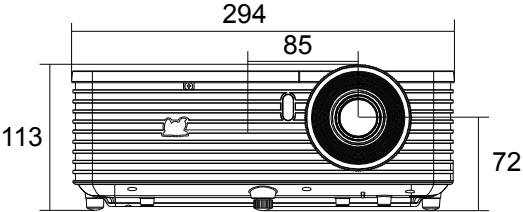
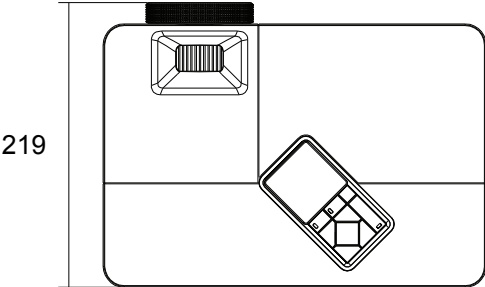

Ceiling mount installation

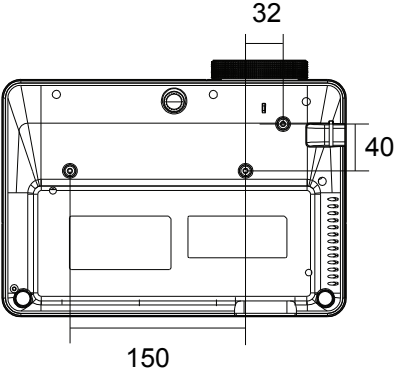

Ceiling mount screws:
M4 x 8 (Max. L = 8 mm)

Unit: mm

Appendix

LED Indicator Messages

LED Type	Color	Status	Meaning
Power LED	Blue	Solid	Standby mode when green mode is turned on.
Temp LED	Red	Off	
Lamp LED	Red	Off	
Power LED	Blue	Flash	Standby mode when green mode is turned off.
Temp LED	Red	Off	
Lamp LED	Red	Off	
Power LED	Blue	Flash	Powering up
Temp LED	Red	Off	
Lamp LED	Red	Off	
Power LED	Blue	Solid	Normal operation
Temp LED	Red	Off	
Lamp LED	Red	Off	
Power LED	Blue	Solid	Powering down
Temp LED	Red	Off	
Lamp LED	Red	Off	
Power LED	Blue	Solid	If the projector system has some problems with its fans, the projector will shut down.
Temp LED	Red	Flash	
Lamp LED	Red	Flash	
Power LED	Blue	Solid	The lamp has reached its end of life and must be changed soon. The lamp will continue to operate until it fails. Change the lamp. If the lamp is off, then the ballast will become malfunction.
Temp LED	Red	Off	
Lamp LED	Red	Flash	
Power LED	Blue	Flash	1. Temperature is too high. The lamp will turn off. The fan motor is cooling the lamp. Or 2. The cooling process is not complete after the projector is shut down and re-started right away.
Temp LED	Red	Flash	
Lamp LED	Red	Off	
Power LED	Blue	Flash	The lamp ignition failed. If temperature is too high, the fans will cool the lamp.
Temp LED	Red	Off	
Lamp LED	Red	Solid	

Compatibility Modes

Computer:

Resolution	H-Sync [KHz]	V-Sync [Hz]
640 x 350	37.9	85.0
640 x 480	24.6	50.0
	31.5	59.9
	37.9	72.8
	37.5	75.0
	43.3	85.0
	61.9	120.0
720 x 400	31.5	70.0
	37.9	85.0
800 x 600	31.0	50.0
	35.2	56.0
	37.9	60.3
	48.1	72.0
	46.9	75.0
	53.7	85.1
	76.3	120.0
1024 x 768	48.4	60.0
	56.5	70.1
	60.0	75.0
	68.7	85.0
	97.6	120.0
1152 x 864	67.5	75.0
1280 x 768	47.8	60.0
1280 x 960	60.0	60.0
	85.9	85.0
1280 x 1024	64.0	60.0
1400 x 1050	65.3	60.0
1600 x 1200	75.0	60.0
1680 x 1050	65,3	60,0

Video:

Compatibility	Resolution	H-Sync [KHz]	V-Sync [Hz]
480i	720 x 480	15.8	60
480p	720 x 480	31.5	60
576i	720 x 576	15.8	50
576p	720 x 576	31.3	50
720p	1280 x 720	37.5	50
720p	1280 x 720	45	60
1080i	1920 x 1080	33.8	60
1080i	1920 x 1080	28.1	50
1080p	1920 x 1080	67.5	60
1080p	1920 x 1080	56.3	50

Troubleshooting

Refer to the symptoms and measures listed below before sending the projector for repairs. If the problem persists, contact your local reseller or service center. Please refer to "LED Indicator Messages" as well.

Start-up problems

If no lights turn on:

- Be sure that the power cord is securely connected to the projector and the other end is plugged into an outlet with power.
- Press the power button again.
- Unplug the power cord and wait for a short while, then plug it in and press the power button again.

Image problems

If the searching source is displayed:

- Press **SOURCE** on the projector or **Source** on the remote control to select an active input source.
- Be sure the external source is turned on and connected.
- For a computer connection, ensure your notebook computer's external video port is turned on. Refer to the computer manual.

If the image is out of focus:

- Be sure the lens cover is removed.
- While displaying the on-screen menu, adjust the focus ring. (The image size should not change; if it does, you are adjusting the zoom, not the focus.)
- Check the projection lens to see if it needs cleaning.

If the image is flickering or unstable for a computer connection:

- Press **Auto Sync** on the remote control.
- Press **MENU** on the projector or **Menu** on the remote control, go to **Video/Audio** and adjust **Frequency** or **Tracking**.

Remote control problems

If the remote control does not operate:

- Be sure nothing is blocking the remote control receiver on the front of the projector. Use the remote control within the effective range.
- Aim the remote control at the screen or at the front or back of the projector.
- Move the remote control so it is more directly in front of or behind the projector and not as far to the side.

RS-232 Command and Configuration

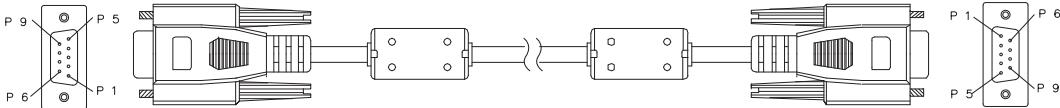

D-Sub 9 pin

1	1 CD
2	RXD
3	TXD
4	DTR
5	GND
6	DSR
7	RTS
8	CTS
9	RI

Wire List

C1	COLOR	C2
1	Black	1
2	Brown	3
3	Red	2
4	Orange	6
5	Yellow	5
6	Green	4
7	Blue	8
8	Purple	7
9	White	9
SHELL	DW	SHELL

Baud Rate	115200 bps (default)
Data Length	8 bit
Parity Check	None
Stop Bit	1 bit
Flow Control	None

Function	Action	Control Code
Power	Power on	BE,EF,10,05,00,C6,FF,11,11,01,00,01,00
	Power off	BE,EF,03,06,00,DC,DB,69,00,00,00,00,00
Source input	Computer1	BE,EF,03,19,00,19,29,01,47,02,CC,CC,00
	Computer2	BE,EF,03,19,1E,90,72,01,47,02,CC,CC,00
	S-Video	BE,EF,03,19,00,E8,69,01,47,02,CC,CC,00
	Video	BE,EF,03,19,00,78,A8,01,47,02,CC,CC,00
	HDMI	BE,EF,03,19,00,DA,2B,01,47,02,CC,CC,00
Projector position	Front table	BE,EF,10,07,9F,9D,0E,0A,EF,00,00,00,00
	Rear table	BE,EF,10,07,9F,9D,0E,0A,EF,01,00,00,01
	Front ceiling	BE,EF,10,07,9F,9D,0E,0A,EF,02,00,00,02
	Rear ceiling	BE,EF,10,07,9F,9D,0E,0A,EF,03,00,00,03
OSD	Menu	BE,EF,02,06,00,E9,D3,30,00,00,00,00,00
	Up	BE,EF,02,06,00,6D,D2,34,00,00,00,00,00
	Down	BE,EF,02,06,00,0B,D2,32,00,00,00,00,00
	Left	BE,EF,02,06,00,DA,D3,33,00,00,00,00,00
	Right	BE,EF,02,06,00,38,D2,31,00,00,00,00,00
Lamp	ECO on	BE,EF,03,06,00,EF,DB,6A,00,00,00,00,00
	ECO off	BE,EF,03,06,00,3E,DA,6B,00,00,00,00,00
	Using hours	BE,EF,03,06,00,BA,DB,6F,00,00,00,00,00
Fan	High Attitude on	BE,EF,02,06,00,40,D3,80,00,00,00,00,01
	High Attitude off	BE,EF,02,06,00,40,D3,80,00,00,00,00,00
Keystone	Keystone up	BE,EF,03,06,00,10,DB,65,00,00,00,00,00
	Keystone down	BE,EF,03,06,00,23,DB,66,00,00,00,00,00
Aspect ratio	4:3	BE,EF,03,06,00,0D,DA,68,00,01,00,00,01
	16:9	BE,EF,03,06,00,0D,DA,68,00,02,00,00,02
	Anamorphic/Wide	BE,EF,03,06,00,0D,DA,68,00,02,00,00,04
	Auto	BE,EF,03,06,00,0D,DA,68,00,02,00,00,00
Blank	Blank on	BE,EF,02,06,00,DF,DF,66,00,01,00,00,01
	Blank off	BE,EF,02,06,00,DF,DF,66,00,02,00,00,02
Freeze	Freeze on	BE,EF,02,06,00,02,D0,2B,00,01,00,00,01
	Freeze off	BE,EF,02,06,00,02,D0,2B,00,02,00,00,02
Volume	Volume +	BE,EF,02,06,00,F1,DE,68,00,00,00,00,00
	Volume -	BE,EF,02,06,00,20,DF,69,00,00,00,00,00
	Mute on	BE,EF,02,06,00,0E,DE,67,00,01,00,00,01
	Mute off	BE,EF,02,06,00,0E,DE,67,00,02,00,00,02
Auto source	Auto source on	BE,EF,03,06,00,89,DB,6C,00,00,00,00,00
	Auto source off	BE,EF,03,06,00,58,DA,6D,00,00,00,00,00
Auto Sync		BE,EF,02,06,00,86,D1,2F,00,00,00,00,00
Factory default		BE,EF,03,06,00,6B,DA,6E,00,00,00,00,00
Firmware version		BE,EF,03,06,00,D5,D9,70,00,00,00,00,00
System Status		BE,EF,03,06,00,04,D8,71,00,00,00,00,00
3D Sync	3D Sync on	BE,EF,02,06,00,54,EF,7C,00,01,00,00,01
	3D Sync off	BE,EF,02,06,00,54,EF,7C,00,00,00,00,00
	Top-Bottom	BE,EF,02,06,00,54,EF,7C,00,01,00,00,02
	Frame Sequential	BE,EF,02,06,00,54,EF,7C,00,01,00,00,03
	Frame Packing	BE,EF,02,06,00,54,EF,7C,00,01,00,00,04
	Side-By-Side	BE,EF,02,06,00,54,EF,7C,00,01,00,00,05

Color mode	Brightest	BE,EF,03,06,00,38,5A,88,12,08,08,12,08
	PC	BE,EF,03,06,00,38,5A,88,10,00,00,10,00
	Movie	BE,EF,03,06,00,38,5A,88,13,01,01,13,01
	ViewMatch	BE,EF,03,06,00,38,5A,88,14,02,02,14,02
	White Board	BE,EF,03,06,00,38,5A,88,15,05,05,15,05
	Black Board	BE,EF,03,06,00,38,5A,88,16,06,06,16,06
	Green Board	BE,EF,03,06,00,38,5A,88,17,07,07,17,07
	User 1	BE,EF,03,06,00,38,5A,88,18,03,03,18,03
	User 2	BE,EF,03,06,00,38,5A,88,19,04,04,19,04
Language	English	BE,EF,1A,0C,00,09,0B,3A,00,01,00,00,01
	Nederlands	BE,EF,1A,0C,00,09,0B,3A,00,02,00,00,02
	Français	BE,EF,1A,0C,00,09,0B,3A,00,03,00,00,03
	Español	BE,EF,1A,0C,00,09,0B,3A,00,04,00,00,04
	Italiano	BE,EF,1A,0C,00,09,0B,3A,00,05,00,00,05
	한국어	BE,EF,1A,0C,00,09,0B,3A,00,06,00,00,06
	ไทย	BE,EF,1A,0C,00,09,0B,3A,00,07,00,00,07
	Português	BE,EF,1A,0C,00,09,0B,3A,00,08,00,00,08
	繁體中文	BE,EF,1A,0C,00,09,0B,3A,00,09,00,00,09
	简体中文	BE,EF,1A,0C,00,09,0B,3A,00,0A,00,00,0A
	日本語	BE,EF,1A,0C,00,09,0B,3A,00,0B,00,00,0B
	Русский	BE,EF,1A,0C,00,09,0B,3A,00,0C,00,00,0C
	Deutsch	BE,EF,1A,0C,00,09,0B,3A,00,0D,00,00,0D
	Svenska	BE,EF,1A,0C,00,09,0B,3A,00,0E,00,00,0E
	Türkçe	BE,EF,1A,0C,00,09,0B,3A,00,0F,00,00,0F
	Suomi	BE,EF,1A,0C,00,09,0B,3A,00,10,00,00,10
	Polski	BE,EF,1A,0C,00,09,0B,3A,00,11,00,00,11
	Indonesia	BE,EF,1A,0C,00,09,0B,3A,00,12,00,00,12
	العربية	BE,EF,1A,0C,00,09,0B,3A,00,13,00,00,13
हिन्दी	BE,EF,1A,0C,00,09,0B,3A,00,14,00,00,14	
Magnify	Magnify Inc	BE,EF,02,06,00,22,55,76,00,00,00,00,01
	Magnify Dec	BE,EF,02,06,00,22,55,76,00,00,00,00,00
Green Mode	Green Mode On	BE,EF,02,06,00,40,B5,86,00,00,00,00,01
	Green Mode Off	BE,EF,02,06,00,40,B5,86,00,00,00,00,00
Dynamic Mode	Dynamic Mode On	BE,EF,02,06,00,D3,D1,2A,00,00,00,00,01
	Dynamic Mode Off	BE,EF,03,06,00,EE,DA,6B,00,00,00,00,01
Quick Power Off	QuickPowerOff_On	BE,EF,10,05,00,C6,FF,11,11,01,00,01,01
	QuickPowerOff_Off	BE,EF,03,06,00,DC,DB,69,69,00,00,69,00

IR Control Code

System Code: 83F4

Format : NEC



Key	Format	Byte1	Byte2	Byte3	Byte4
Power	NEC	83	F4	17	E8
Auto Sync	NEC	83	F4	08	f7
VGA1	NEC	83	F4	41	be
VGA2	NEC	83	F4	45	ba
Video	NEC	83	F4	52	ad
Source	NEC	83	F4	40	bf
Color Mode	NEC	83	F4	10	ef
Enter	NEC	83	F4	15	ea
Up / Keystne+	NEC	83	F4	0b	f4
Down / Keystone-	NEC	83	F4	0c	f3
Left	NEC	83	F4	0e	f1
Right	NEC	83	F4	0f	f0
Menu	NEC	83	F4	30	CF
My Button(Function)	NEC	83	F4	56	A9
Exit	NEC	83	F4	28	D7
Mouse	NEC	83	F4	31	CE
Mouse left	NEC	83	F4	36	C9
Mouse right	NEC	83	F4	37	C8
Mouse Page Up	NEC	83	F4	06	F9
Mouse Page Down	NEC	83	F4	05	FA
Lock(Key pad)	NEC	83	F4	8E	71
Pattern	NEC	83	F4	55	AA
D.Eco (Dynamic Eco)	NEC	83	F4	2B	D4
Magnify +	NEC	83	F4	18	e7
Freeze	NEC	83	F4	03	fc
Blank	NEC	83	F4	07	f8
Timer (Presentation)	NEC	83	F4	27	d8
Volume+	NEC	83	F4	82	7D
Volume-	NEC	83	F4	83	7C
Mute	NEC	83	F4	14	eb
Aspect	NEC	83	F4	13	EC

Customer Support

For technical support or product service, see the table below or contact your reseller.

Note : You will need the product serial number.

Country/Region	Website	T = Telephone F = FAX	Email
Australia/New Zealand	www.viewsonic.com.au	AUS= 1800 880 818 NZ= 0800 008 822	service@au.viewsonic.com
Canada	www.viewsonic.com	T (Toll-Free)= 1-866-463-4775 T (Toll)= 1-424-233-2533 F= 1-909-468-3757	service.ca@viewsonic.com
Europe	www.viewsoniceurope.com	www.viewsoniceurope.com/uk/support/call-desk/	
Hong Kong	www.hk.viewsonic.com	T= 852 3102 2900	service@hk.viewsonic.com
India	www.in.viewsonic.com	T= 1800 266 0101	service@in.viewsonic.com
Korea	www.kr.viewsonic.com	T= 080 333 2131	service@kr.viewsonic.com
Latin America (Argentina)	www.viewsonic.com/la/	T= 0800-4441185	soporte@viewsonic.com
Latin America (Chile)	www.viewsonic.com/la/	T= 1230-020-7975	soporte@viewsonic.com
Latin America (Columbia)	www.viewsonic.com/la/	T= 01800-9-157235	soporte@viewsonic.com
Latin America (Mexico)	www.viewsonic.com/la/	T= 001-8882328722	soporte@viewsonic.com
Renta y Datos, 29 SUR 721, COL. LA PAZ, 72160 PUEBLA, PUE. Tel: 01.222.891.55.77 CON 10 LINEAS Electroser, Av Reforma No. 403Gx39 y 41, 97000 Mérida, Yucatán. Tel: 01.999.925.19.16 Other places please refer to http://www.viewsonic.com/la/soporte/index.htm#Mexico			
Latin America (Peru)	www.viewsonic.com/la/	T= 0800-54565	soporte@viewsonic.com
Macau	www.hk.viewsonic.com	T= 853 2870 0303	service@hk.viewsonic.com
Middle East	ap.viewsonic.com/me/	Contact your reseller	service@ap.viewsonic.com
Puerto Rico & Virgin Islands	www.viewsonic.com	T= 1-800-688-6688 (English) T= 1-866-379-1304 (Spanish) F= 1-909-468-3757	service.us@viewsonic.com soporte@viewsonic.com
Singapore/Malaysia/ Thailand	www.viewsonic.com.sg	T= 65 6461 6044	service@sg.viewsonic.com
South Africa	ap.viewsonic.com/za/	Contact your reseller	service@ap.viewsonic.com
United States	www.viewsonic.com	T (Toll-Free)= 1-800-688-6688 T (Toll)= 1-424-233-2530 F= 1-909-468-3757	service.us@viewsonic.com

Limited Warranty

ViewSonic® Projector

What the warranty covers:

ViewSonic warrants its products to be free from defects in material and workmanship, under normal use, during the warranty period. If a product proves to be defective in material or workmanship during the warranty period, ViewSonic will, at its sole option, repair or replace the product with a like product. Replacement product or parts may include remanufactured or refurbished parts or components.

Limited Three (3) year General Warranty

Subject to the more limited one (1) year warranty set out below, North and South America: Three (3) years warranty for all parts excluding the lamp, three (3) years for labor, and one (1) year for the original lamp from the date of the first consumer purchase.

Other regions or countries: Please check with your local dealer or local ViewSonic office for the warranty information.

Limited One (1) year Heavy Usage Warranty:

Under heavy usage settings, where a projector's use includes more than fourteen (14) hours average daily usage, North and South America: One (1) year warranty for all parts excluding the lamp, one (1) year for labor, and ninety (90) days for the original lamp from the date of the first consumer purchase; Europe: One (1) year warranty for all parts excluding the lamp, one (1) year for labor, and ninety (90) days for the original lamp from the date of the first consumer purchase.

Other regions or countries: Please check with your local dealer or local ViewSonic office for the warranty information.

Lamp warranty subject to terms and conditions, verification and approval. Applies to manufacturer's installed lamp only. All accessory lamps purchased separately are warranted for 90 days.

Who the warranty protects:

This warranty is valid only for the first consumer purchaser.

What the warranty does not cover:

1. Any product on which the serial number has been defaced, modified or removed.
2. Damage, deterioration, failure, or malfunction resulting from:
 - a. Accident, abuse, misuse, neglect, fire, water, lightning, or other acts of nature, improper maintenance, unauthorized product modification, or failure to follow instructions supplied with the product.
 - b. Operation outside of product specifications.
 - c. Operation of the product for other than the normal intended use or not under normal conditions.
 - d. Repair or attempted repair by anyone not authorized by ViewSonic.
 - e. Any damage of the product due to shipment.
 - f. Removal or installation of the product.
 - g. Causes external to the product, such as electric power fluctuations or failure.
 - h. Use of supplies or parts not meeting ViewSonic's specifications.
 - i. Normal wear and tear.
 - j. Any other cause which does not relate to a product defect.
3. Removal, installation, and set-up service charges.

How to get service:

1. For information about receiving service under warranty, contact ViewSonic Customer Support (please refer to “Customer Support” page). You will need to provide your product’s serial number.
2. To obtain warranted service, you will be required to provide (a) the original dated sales slip, (b) your name, (c) your address, (d) a description of the problem, and (e) the serial number of the product.
3. Take or ship the product freight prepaid in the original container to an authorized ViewSonic service center or ViewSonic.
4. For additional information or the name of the nearest ViewSonic service center, contact ViewSonic.

Limitation of implied warranties:

There are no warranties, express or implied, which extend beyond the description contained herein including the implied warranty of merchantability and fitness for a particular purpose.

Exclusion of damages:

ViewSonic’s liability is limited to the cost of repair or replacement of the product.

ViewSonic shall not be liable for:

1. Damage to other property caused by any defects in the product, damages based upon inconvenience, loss of use of the product, loss of time, loss of profits, loss of business opportunity, loss of goodwill, interference with business relationships, or other commercial loss, even if advised of the possibility of such damages.
2. Any other damages, whether incidental, consequential or otherwise.
3. Any claim against the customer by any other party.

Effect of local law:

This warranty gives you specific legal rights, and you may also have other rights which vary from local authority. Some local governances do not allow limitations on implied warranties and/or do not allow the exclusion of incidental or consequential damages, so the above limitations and exclusions may not apply to you.

Sales outside the U.S.A. and Canada:

For warranty information and service on ViewSonic products sold outside of the U.S.A. and Canada, contact ViewSonic or your local ViewSonic dealer.

The warranty period for this product in mainland China (Hong Kong, Macao and Taiwan Excluded) is subject to the terms and conditions of the Maintenance Guarantee Card.

For users in Europe and Russia, full details of warranty provided can be found in www.viewsoniceurope.com under Support/Warranty Information.

Mexico Limited Warranty

ViewSonic® Projector

What the warranty covers:

ViewSonic warrants its products to be free from defects in material and workmanship, under normal use, during the warranty period. If a product proves to be defective in material or workmanship during the warranty period, ViewSonic will, at its sole option, repair or replace the product with a like product. Replacement product or parts may include remanufactured or refurbished parts or components & accessories.

How long the warranty is effective:

3 years for all parts excluding the lamp, 3 years for labor, 1 year for the original lamp from the date of the first consumer purchase.

Lamp warranty subject to terms and conditions, verification and approval. Applies to manufacturer's installed lamp only.

All accessory lamps purchased separately are warranted for 90 days.

Who the warranty protects:

This warranty is valid only for the first consumer purchaser.

What the warranty does not cover:

1. Any product on which the serial number has been defaced, modified or removed.
2. Damage, deterioration or malfunction resulting from:
 - a. Accident, misuse, neglect, fire, water, lightning, or other acts of nature, unauthorized product modification, unauthorized attempted repair, or failure to follow instructions supplied with the product.
 - b. Any damage of the product due to shipment.
 - c. Causes external to the product, such as electrical power fluctuations or failure.
 - d. Use of supplies or parts not meeting ViewSonic's specifications.
 - e. Normal wear and tear.
 - f. Any other cause which does not relate to a product defect.
3. Any product exhibiting a condition commonly known as "image burn-in" which results when a static image is displayed on the product for an extended period of time.
4. Removal, installation, insurance, and set-up service charges.

How to get service:

For information about receiving service under warranty, contact ViewSonic Customer Support (Please refer to the attached Customer Support page). You will need to provide your product's serial number, so please record the product information in the space provided below on your purchase for your future use. Please retain your receipt of proof of purchase to support your warranty claim.

For Your Records

Product Name: _____ Model Number: _____
Document Number: _____ Serial Number: _____
Purchase Date: _____ Extended Warranty Purchase? _____ (Y/N)
If so, what date does warranty expire? _____

1. To obtain warranty service, you will be required to provide (a) the original dated sales slip, (b) your name, (c) your address, (d) a description of the problem, and (e) the serial number of the product.
2. Take or ship the product in the original container packaging to an authorized ViewSonic service center.
3. Round trip transportation costs for in-warranty products will be paid by ViewSonic.

Limitation of implied warranties:

There are no warranties, express or implied, which extend beyond the description contained herein including the implied warranty of merchantability and fitness for a particular purpose.

Exclusion of damages:

ViewSonic's liability is limited to the cost of repair or replacement of the product. ViewSonic shall not be liable for:

1. Damage to other property caused by any defects in the product, damages based upon inconvenience, loss of use of the product, loss of time, loss of profits, loss of business opportunity, loss of goodwill, interference with business relationships, or other commercial loss, even if advised of the possibility of such damages.
2. Any other damages, whether incidental, consequential or otherwise.
3. Any claim against the customer by any other party.
4. Repair or attempted repair by anyone not authorized by ViewSonic.

Contact Information for Sales & Authorized Service (Centro Autorizado de Servicio) within Mexico:	
Name, address, of manufacturer and importers: México, Av. de la Palma #8 Piso 2 Despacho 203, Corporativo Interpalmas, Col. San Fernando Huixquilucan, Estado de México Tel: (55) 3605-1099 http://www.viewsonic.com/la/soporte/index.htm	
NÚMERO GRATIS DE ASISTENCIA TÉCNICA PARA TODO MÉXICO: 001.866.823.2004	
Hermosillo: Distribuciones y Servicios Computacionales SA de CV. Calle Juarez 284 local 2 Col. Bugambillas C.P: 83140 Tel: 01-66-22-14-9005 E-Mail: disc2@hmo.megared.net.mx	Villahermosa: Compumantenimientos Garantizados, S.A. de C.V. AV. GREGORIO MENDEZ #1504 COL, FLORIDA C.P. 86040 Tel: 01 (993) 3 52 00 47 / 3522074 / 3 52 20 09 E-Mail: compumantenimientos@prodigy.net.mx
Puebla, Pue. (Matriz): RENTA Y DATOS, S.A. DE C.V. Domicilio: 29 SUR 721 COL. LA PAZ 72160 PUEBLA, PUE. Tel: 01(52).222.891.55.77 CON 10 LINEAS E-Mail: datos@puebla.megared.net.mx	Veracruz, Ver.: CONEXION Y DESARROLLO, S.A DE C.V. Av. Americas # 419 ENTRE PINZÓN Y ALVARADO Fracc. Reforma C.P. 91919 Tel: 01-22-91-00-31-67 E-Mail: gacosta@qplus.com.mx
Chihuahua Soluciones Globales en Computación C. Magisterio # 3321 Col. Magisterial Chihuahua, Chih. Tel: 4136954 E-Mail: Cefeo@soluglobales.com	Cuernavaca Compusupport de Cuernavaca SA de CV Francisco Leyva # 178 Col. Miguel Hidalgo C.P. 62040, Cuernavaca Morelos Tel: 01 777 3180579 / 01 777 3124014 E-Mail: aquevedo@compusupportcva.com
Distrito Federal: QPLUS, S.A. de C.V. Av. Coyoacán 931 Col. Del Valle 03100, México, D.F. Tel: 01(52)55-50-00-27-35 E-Mail : gacosta@qplus.com.mx	Guadalajara, Jal.: SERVICRECE, S.A. de C.V. Av. Niños Héroes # 2281 Col. Arcos Sur, Sector Juárez 44170, Guadalajara, Jalisco Tel: 01(52)33-36-15-15-43 E-Mail: mmiranda@servicrece.com
Guerrero Acapulco GS Computación (Grupo Sesicomp) Progreso #6-A, Colo Centro 39300 Acapulco, Guerrero Tel: 744-48-32627	Monterrey: Global Product Services Mar Caribe # 1987, Esquina con Golfo Pérsico Fracc. Bernardo Reyes, CP 64280 Monterrey N.L. México Tel: 8129-5103 E-Mail: aydeem@gps1.com.mx
MERIDA: ELECTROSER Av Reforma No. 403Gx39 y 41 Mérida, Yucatán, México CP97000 Tel: (52) 999-925-1916 E-Mail: rrrb@sureste.com	Oaxaca, Oax.: CENTRO DE DISTRIBUCION Y SERVICIO, S.A. de C.V. Murguía # 708 P.A., Col. Centro, 68000, Oaxaca Tel: 01(52)95-15-15-22-22 Fax: 01(52)95-15-13-67-00 E-Mail: gpotai2001@hotmail.com
Tijuana: STD Av Ferrocarril Sonora #3780 L-C Col 20 de Noviembre Tijuana, Mexico	FOR USA SUPPORT: ViewSonic Corporation 381 Brea Canyon Road, Walnut, CA. 91789 USA Tel: 800-688-6688 (English); 866-323-8056 (Spanish); Fax: 1-800-685-7276 E-Mail: http://www.viewsonic.com



ViewSonic®